



TECHNICAL DATA SHEET

600 SERIES HOT LINE



AIM AEI46-NK

ELECTRICAL GRILL - RIBBED SURFACE - CHROME

- With its stainless steel construction, it is long-lasting and easy to use. It is cleanable and hygienic.
- Ergonomic that provides convenience to the user in every aspect. It has a design.
- Device depth is 600 mm.
- The device is a countertop.
- Height adjustable feet on the device available.
- The cooking plate of the device is heat resistant, ST52 steel. These are products produced in 12 mm. In addition, the device; Front panel sheet 1mm AISI 304, Top table sheet metal 1 mm AISI 304, body side sheets 1 mm AISI 430, rear chimney construction covering sheet is 1 mm AISI 430, chimney ventilation sheet 1.5 mm AISI 304 supporting produced.
- When the oil reservoir is full and not emptied from its reservoir thanks to the overflow holes in the front. It overflows and oil inside the device is prevented.
- Easily removed from the drawer and cleaned. It is in structure.
- Heaters are controlled by thermostat between 50°C-300°C. is done.
- Resistors and thermostat used in the device. Homogeneous temperature on the cooking plate thanks to its control distribution is carried out.
- There are two different buttons next to the heat adjustment button on the device. There is a colored signal lamp. Green signal lamp it indicates that the device is receiving electricity. Yellow signa the lamp indicates that the resistance is active. It burns until it reaches the desired temperature. It will turn off when reached.
- In this product family; Corrugated (Ribbed) and Chrome (CR). There are alternative coated products.



600 SERIES HOT LINE AIM AEI46-NK



TECHNICAL DATA SHEET

ÖN / FRONT

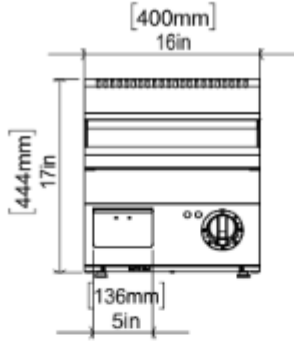

GENERAL INFORMATION

Model: AIM AEI46-NK
 Dimension: 400x600x300
 Net Weight (kg):41
 Cooking Area(mm): 495x396
 Thermostat Working Range: 50 °C min; 300 °C max

SAG / RIGHT

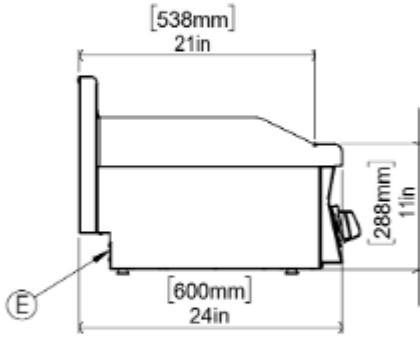

ELECTRICAL INFORMATION

Voltage: 380-415V
 Electric power: 4,5 kW
 Amper:20,5A
 Cable Section: 5x2,5 mm² TTR
 Frequency: 50-60hz
 Protection Class: IPX4
 Min/max internal humidity:70%/85%
 Control type: Manual

ÜST / TOP

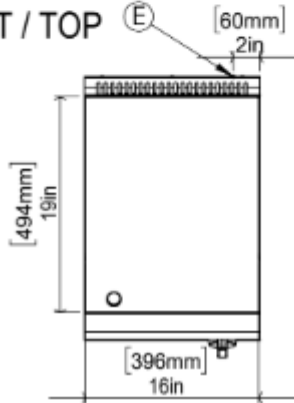

PACKAGE INFORMATION

Dimension: 500x690x575
 Package Weight (kg): 48
 Volume (m³): 0,20 m³

Important Note: The current value given for the device is based on the amount drawn by the device. Is the current value. Cable distance to be connected to the device. The fuse amperage value that should be used according to the length must be determined by a competent electrician.