



TECHNICAL DATA SHEET

LOW LEVEL SERIES



AIM 247LR3

LOW LEVEL REFRIGERATOR -W/3 DOORS

- Designed to operate in 43°C ambient %65 humidity
 - New design for equal temperature distribution
 - Zero ODP Injected 42 kg/m³ Polyurethane Insulation
 - Digital controller with easy read screen
 - Ergonomic door and handle designed for ease of opening and cleaning
 - Icecool refrigeration system designed to be most technologically advanced and energy efficient
 - Hot gas defrost system
 - Waste heat recovery condensate vaporiser system
 - All refrigerators can be produced in marine version
-
- For 1/1 drawers; 1/1-200mm Gn capacity
 - For 1/2 drawers; 1/1-100mm Gn capacity



LOW LEVEL SERIES AIM 247LR3





TECHNICAL DATA SHEET

Operating Temperature: -2/+8 °C
Capacity: 450L
Overall dimensions: 2400x700x600

CABINET CONSTRUCTION

Exterior Material: AISI 304 Stainless Steel
Back Material: Galvanized steel
Interior Material: AISI 304 Stainless Steel
Drain: ✓
LED lighting Eclairage LED: X
Insulation: Polyurethane with high density
40kg/m³, CFCs free, zero ODP and low GWP
Insulation thickness(mm): 50
Blowing Agent: HFO
Doors: 4
Door Construction: Pressed hinged door. Easy
to replace door gasket that does not require
cleaning
Door Lock: Optional
Door Frame Heaters: X

FEATURES

Shelving: 1x2
Shelves dimensions LxD: 470x405
Legs, casters: Stainless steel legs,
height adjustable (130-180mm)

REFRIGERATION

Thermostat: Touch screen- IP65
Refrigeration system: Split system
Defrost: Resistance
Expansion Device: Capillary
Fans: ✓
Condensation: Forced air
Evaporation: With fan
Condensate pan: Hot gas condensation pan

TECHNICAL FEATURES

Gas Refrigerant: R134A
Power Supply: 230V / 1 / 50 Hz

CRATING

Crated dimensions L x l x H (mm):2450x750x850
Net Weight (kg): 177
Crated Weight (kg): 187



LOW LEVEL SERIES AIM 247LR3





TECHNICAL DATA SHEET

NEW CONDENSER SYSTEM

Stayclear condenser



CLASSIC



AIMCLEAR

SAVING ENERGY

Eco friendly, HFC – free polyurethane insulation providing low energy consumption



EVAPARATOR DOES NOT SNOW THROUGH HOT GAS DEFROST

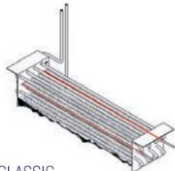

CLASSIC



AIMEVA

PERFECT COOLING SYSTEM

More efficient air circulation with one piece evaporator



CLASSIC



AIMICE

EXTRA INTERNAL VOLUME

Easy to use and extra internal volume by the help of the horizontally positioned evaporator



CLASSIC



AIMEX

PERFECT HEAT CONTROL

With our under counter insulation solution, temperature control is provided perfectly.



CLASSIC



AIM HEAT

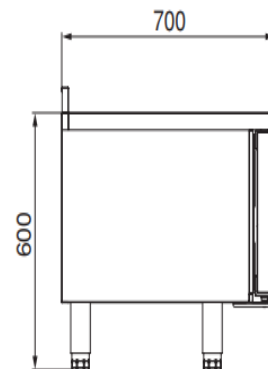
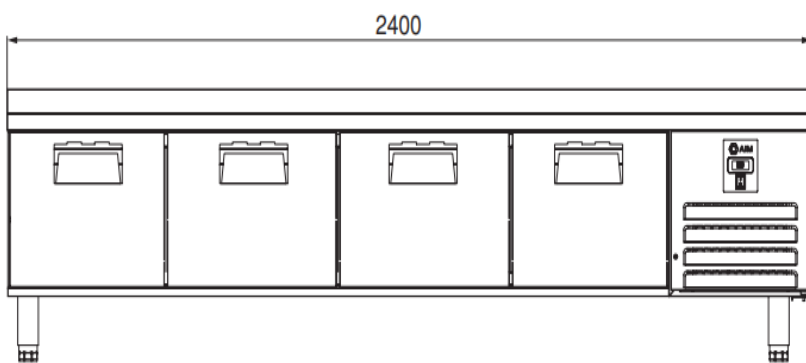

LOW LEVEL SERIES AIM 247LR3



AIM INDUSTRIAL KITCHEN EQUIPMENT
DAP VALLEY S BUILDING NO:10 KAGITHANE / ISTANBUL

