

COOLING

WASHING

FASTFOOD

INOX

HOT



aimgastro.com

ÜRÜN KATALOĞU
PRODUCT CATALOG

123-1
23

INDUSTRIAL
KITCHEN
EQUIPMENT





İÇİNDEKİLER

INDEX

SYF/PG

TEZGAH TİP SOĞUTUCU SERİSİ
COUNTER TYPE SERIES

08

DİKEY TİP SOĞUTUCU SERİSİ
VERTICAL TYPE SERIES

28

SETALTI SOĞUTUCU SERİSİ
LOW LEVEL SERIES

42

HAZIRLIK BUZDOLAPLARI
MAKE UP SERIES

54

ÖZEL SERİ SOĞUTUCULAR
SPECIAL COLDLINE

74

BAR SERİSİ SOĞUTUCULAR
BAR SERIES COOLING LINE

96

UNLU MAMÜL SOĞUTUCULAR
BAKERY COOLING LINE

102

BUZ MAKİNELERİ
ICE CUBE MACHINE

116

YIKAMA EKİPMANLARI
DISWASHER EQUIPMENT

124

FAST FOOD EKİPMANLARI
FAST FOOD EQUIPMENT

140

INOX SERVİS EKİPMANLARI
INOX SERVICE EQUIPMENT

158

YARDIMCI PASLANMAZ ÜRÜNLER
AUXILIARY INOX PRODUCTS

210

600 SERİ PİŞİRME EKİPMANLARI
600 SERIES HOT LINE

224

730 SERİ PİŞİRME EKİPMANLARI
730 SERIES HOT LINE

252

ÖZEL SERİ PİŞİRİCİLER
SPECIAL COOKING LINE

282

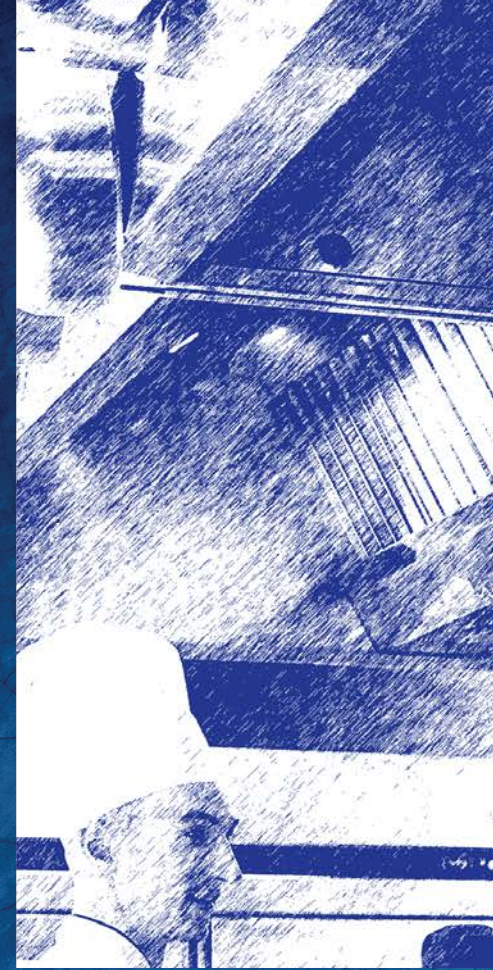

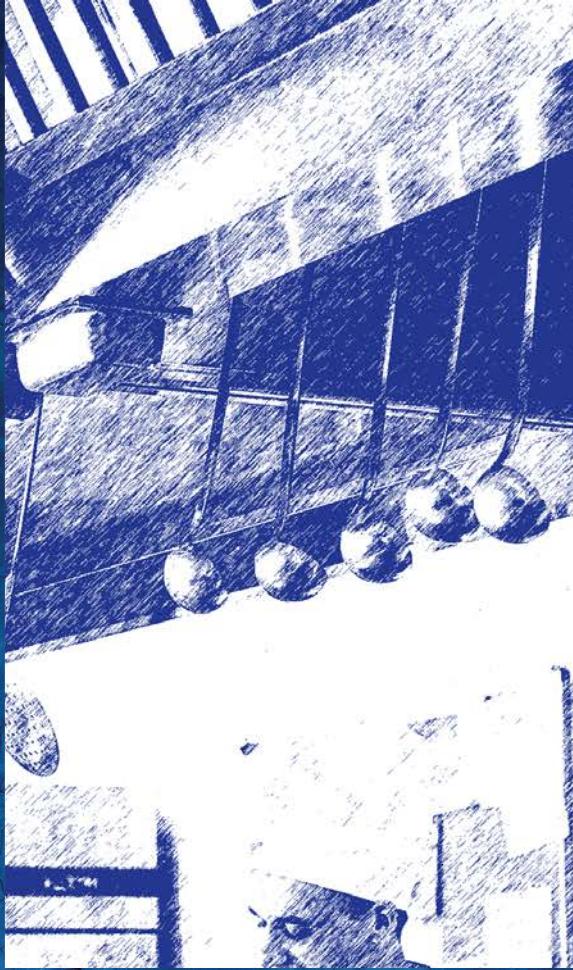



AIM ENDÜSTRİYEL MUTFAK SAN. VE TİC. LTD. ŞTİ.

Bu katalog içeriğinde yer alan tüm (yazı, resim, görüntü, fotoğraf) AIM'a ait olup, Fikir ve Sanat Eserleri Kanunu kapsamında korunmaktadır. Bu hakları ihlal eden kişiler, Fikir ve Sanat eserleri Kanunu ve 5237 sayılı Türk Ceza Kanununda yer alan hukuki ve cezai yaptırımlara tabi olurlar. AIM ilgili yasal işlem başlatma hakkına sahiptir.

TEZGAH TİP BUZDOLAPLARI
COUNTER TYPE REFRIGERATORS

DIKEY TİP BUZDOLAPLARI
VERTICAL TYPE REFRIGERATORS

MAKE UP BUZDOLAPLARI YÜKSEK
MAKE UP REFRIGERATORS - HIGH

PIŞIRICI ALTI BUZDOLAPLARI
LOW LEVEL REFRIGERATORS

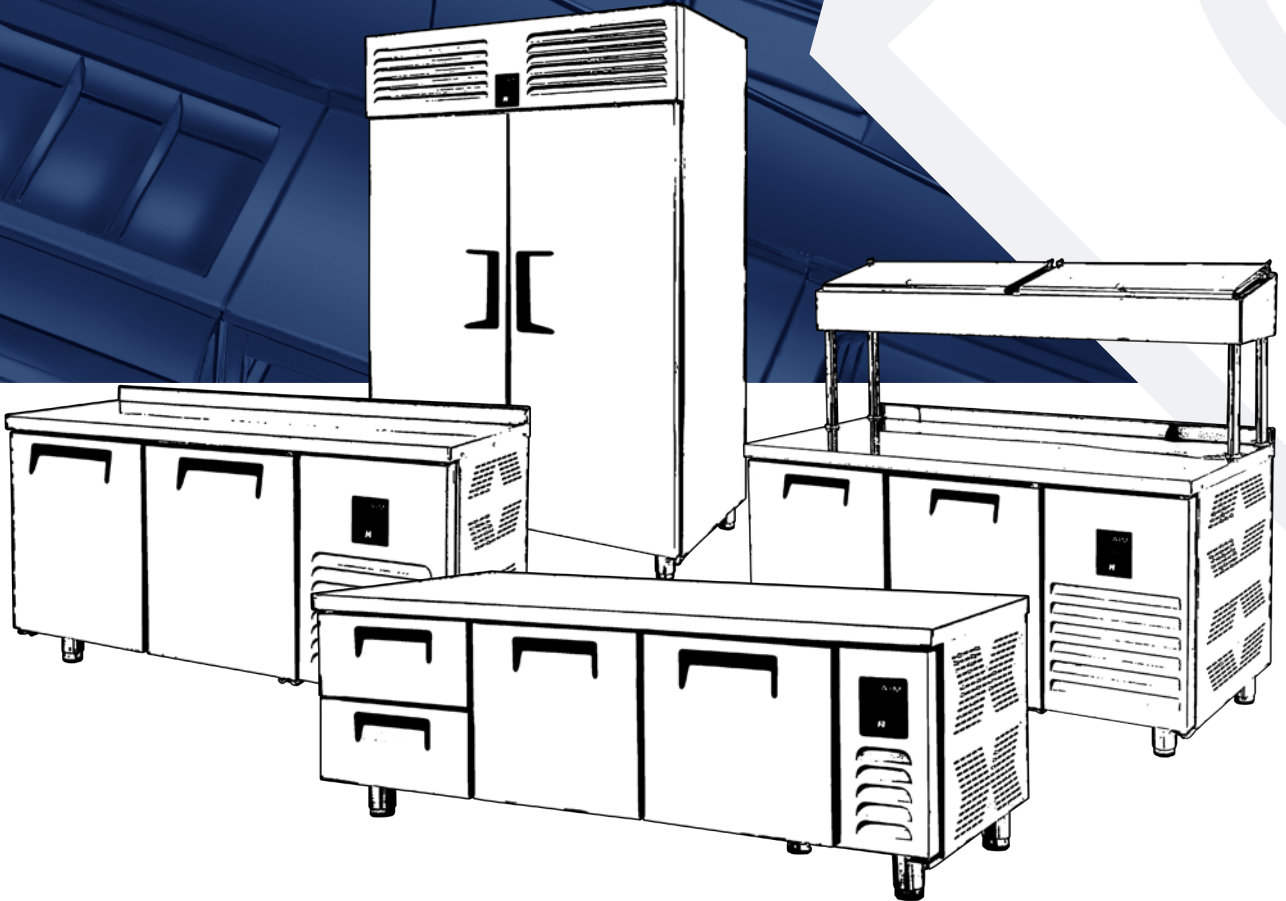

AIM 257

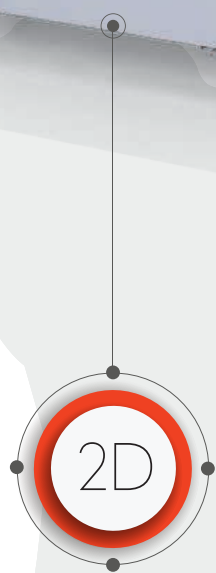
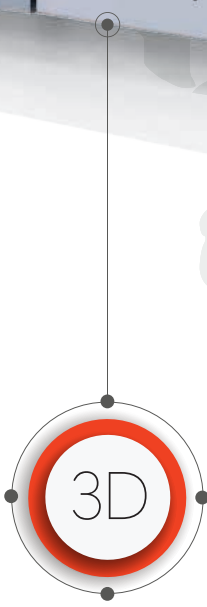

||| AIM 257+3D+2D+UG |||

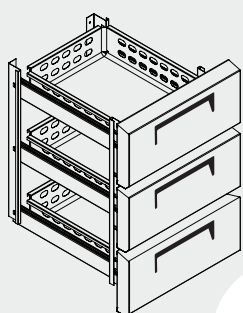
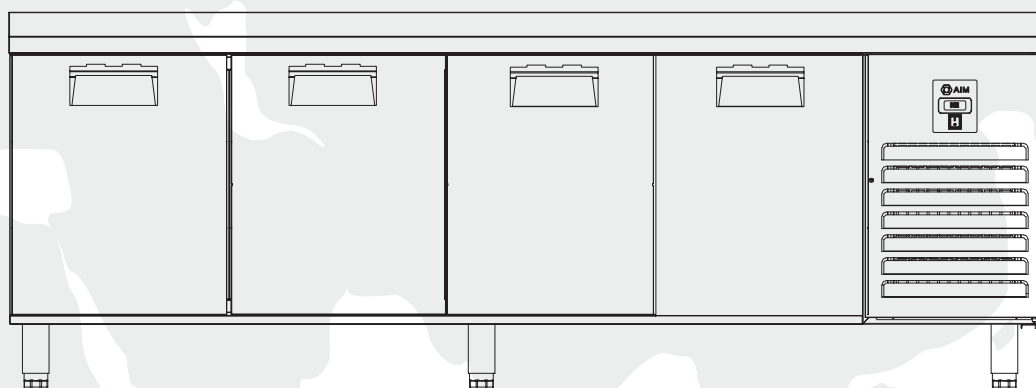

3D

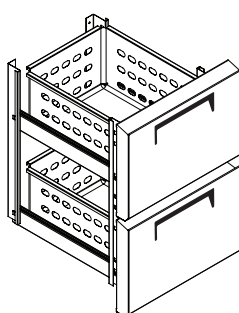

2D



UG

TEZGAH TİP SOĞUTUCU SERİSİ

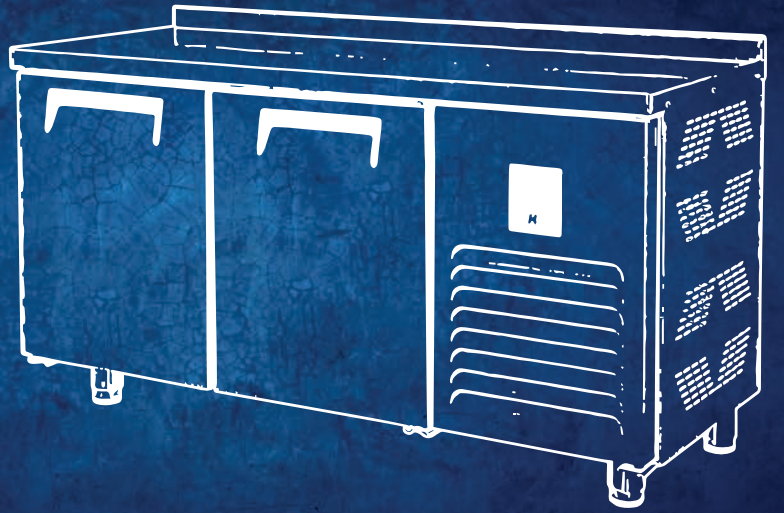

COUNTER TYPE SERIES

YENİ KONDENSER SİSTEMİ NEW CONDENSER SYSTEM



CLASSIC

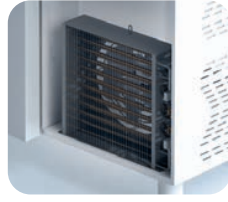

AIMCLEAR

Temizlik gerektirmeyen kondenser
Stayclear Condenser

ENERJİ TASARRUFU SAVING ENERGY



Düşük enerji tüketimi sağlayan çevre dostu
HFC içermeyen poliüretan izolasyon
Eco friendly, HFC - free polyurethane insulation
providing low energy consumption

KUSURSUZ SOĞUTMA SİSTEMİ PERFECT COOLING SYSTEM

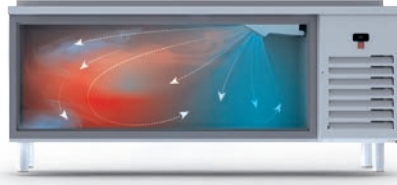

CLASSIC



AIMICE

Yekpare evaporatör ile daha verimli hava sirkülasyonu
More efficient air circulation with one piece evaporator

EKSTRA İÇ HACİM EXTRA INTERNAL VOLUME



CLASSIC



AIMEX

Yatay konumlandırılan evaporatör sayesinde kullanım kolaylığı ve ekstra iç hacim
Easy to use and extra internal volume by the help of the horizontally positioned evaporator

SICAK GAZ DEFROST İLE KARLANMAYAN EVAPARATÖR EVAPARATOR DOES NOT SNOW THROUGH HOT GAS DEFROST

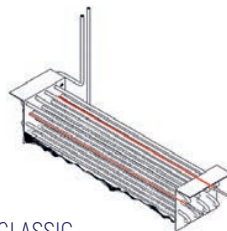

CLASSIC

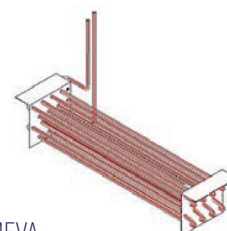

AIMEVA

AIM

AIM 106-107

TEZGAH TİP BUZDOLAPLARI - 1 KAPILI
COUNTER TYPE REFRIGERATORS - W/1 DOOR

NEW PRODUCT



KOD / CODE	°C	(MM)	lit	Power	kg	(kW)	Refrigerant	PASLANMAZ TİPİ S.S. TYPE	€
AIM 106R3	-2 / +8	1000x600x850	125	230V - 50Hz	65	0,16	R134A	304	-
AIM 106R4	-2 / +8	1000x600x850	125	230V - 50Hz	65	0,16	R134A	430	-
AIM 106F3	-10 / -22	1000x600x850	125	230V - 50Hz	65	0,65	R404A	304	-
AIM 106F4	-10 / -22	1000x600x850	125	230V - 50Hz	65	0,65	R404A	430	-
AIM 107R3	-2 / +8	1000x700x850	140	230V - 50Hz	73	0,16	R134A	304	-
AIM 107R4	-2 / +8	1000x700x850	140	230V - 50Hz	73	0,16	R134A	430	-
AIM 107F3	-10 / -22	1000x700x850	140	230V - 50Hz	73	0,65	R404A	304	-
AIM 107F4	-10 / -22	1000x700x850	140	230V - 50Hz	73	0,65	R404A	430	-

 R290 İstenildiği takdirde fiyatlara %3 ilave edilir. / For R290 Refrigerant gas, price increase is 3%.

TEKNİK DETAYLAR / TECHNICAL DETAILS

TR

- Dış ortam sıcaklığı +43°C %65 nem oranı
- Eşit sıcaklık dağılımı için yeni tasarım
- Sıfır ODP enjekte 42 kg/m³ çevre dostu poliüretan izolasyon
- Kolay okunur ekranlı dijital kontrol
- Ergonomik kapı ve kulpu sayesinde kolay açılma ve temizlik
- Patentli 'Icecool' soğutma sistemi ile mükemmel verim ve enerji sarfiyatı
- Sıcak gaz defrost sistemi
- Atık ısı geri kazanımlı kondanzasyon
- Tüm buzdolapların marine versiyonları mevcuttur.
- **1/2 Çekmece için; 1/1-150mm Gn kapasitesi.**
- **1/3 Çekmece için; 1/1-100mm Gn kapasitesi.**

EN

- Designed to operate in 43°C ambient %65 humidity
- New design for equal temperature distribution
- Zero ODP Injected 42 kg/m³ Polyurethane Insulation
- Digital controller with easy read screen
- Ergonomic door and handle designed for ease of opening and cleaning
- Icecool refrigeration system designed to be most technologically advanced and energy efficient yet
- Hot gas defrost system
- Waste heat recovery condensate vaporiser system
- All refrigerators can be produced in marine version
- **For 1/2 drawers; 1/1-150mm Gn capacity**
- **For 1/3 drawers; 1/1-100mm Gn capacity**

AIM 106-107

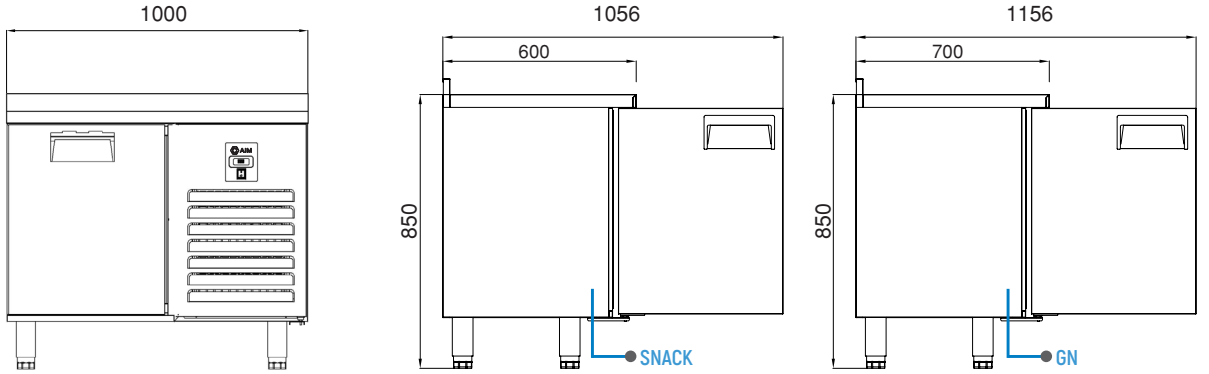

OPSİYONLAR / OPTIONS

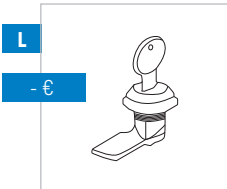

Dolap Kilidi /
Cabinet Lock



Cam Kapı / Glass Door

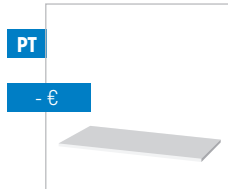

Polietilen Tabla /
Polyethylene Top

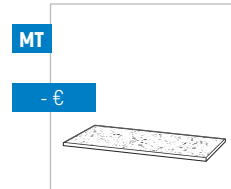

Mermer Tabla /
Marble Top

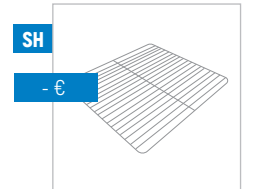

Raf ve Raf Kızağı /
Shelf and Shelf Holder

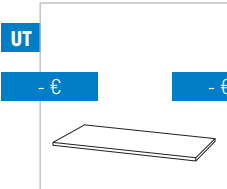

Üst Tablasız /
Without Table Top

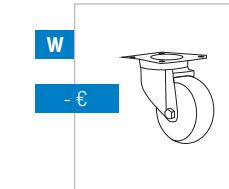

Tekerlekli - Wheels

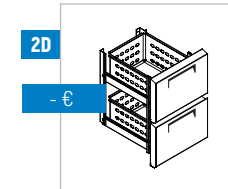

1/2 Çekmece -
1/2 Drawers

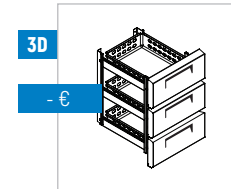

1/3 Çekmece -
1/3 Drawers

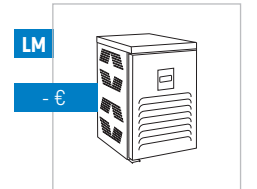

Sol Motor / Left Motor

AIM

AIM 156-157

TEZGAH TİP BUZDOLAPLARI - 2 KAPILI
COUNTER TYPE REFRIGERATORS - W/2 DOORS1/2 ÇEKMECE
1/2 DRAWERS

KOD / CODE	°C	↑ [MM]	İt	⏻	kg	⚡ (KW)	❄️	PASLANMAZ TİPİ S.S. TYPE	€
AIM 156R3	-2 / +8	1500x600x850	275	230V - 50Hz	95	0,32	R134A	304	-
AIM 156R4	-2 / +8	1500x600x850	275	230V - 50Hz	95	0,32	R134A	430	-
AIM 156F3	-10 / -22	1500x600x850	275	230V - 50Hz	95	0,68	R404A	304	-
AIM 156F4	-10 / -22	1500x600x850	275	230V - 50Hz	95	0,68	R404A	430	-
AIM 157R3	-2 / +8	1500x700x850	330	230V - 50Hz	100	0,32	R134A	304	-
AIM 157R4	-2 / +8	1500x700x850	330	230V - 50Hz	100	0,32	R134A	430	-
AIM 157F3	-10 / -22	1500x700x850	330	230V - 50Hz	100	0,68	R404A	304	-
AIM 157F4	-10 / -22	1500x700x850	330	230V - 50Hz	100	0,68	R404A	430	-

 R290 İstenildiği takdirde fiyatlara %3 ilave edilir. / For R290 Refrigerant gas, price increase is 3%.

TEKNİK DETAYLAR / TECHNICAL DETAILS

TR

- Dış ortam sıcaklığı +43°C %65 nem oranı
- Eşit sıcaklık dağılımı için yeni tasarım
- Sıfır ODP enjekte 42 kg/m³ çevre dostu poliüretan izolasyon
- Kolay okunur ekranlı dijital kontrol
- Ergonomik kapı ve kulpu sayesinde kolay açılma ve temizlik
- Patentli 'Icecool' soğutma sistemi ile mükemmel verim ve enerji sarfiyatı
- Sıcak gaz defrost sistemi
- Atık ısı geri kazanımlı kondanzasyon
- Tüm buzdolapların marine versiyonları mevcuttur.
- **1/2 Çekmece için; 1/1-150mm Gn kapasitesi.**
- **1/3 Çekmece için; 1/1-100mm Gn kapasitesi.**

EN

- Designed to operate in 43°C ambient %65 humidity
- New design for equal temperature distribution
- Zero ODP Injected 42 kg/m³ Polyurethane Insulation
- Digital controller with easy read screen
- Ergonomic door and handle designed for ease of opening and cleaning
- Icecool refrigeration system designed to be most technologically advanced and energy efficient yet
- Hot gas defrost system
- Waste heat recovery condensate vaporiser system
- All refrigerators can be produced in marine version
- **For 1/2 drawers; 1/1-150mm Gn capacity**
- **For 1/3 drawers; 1/1-100mm Gn capacity**

AIM 156-157

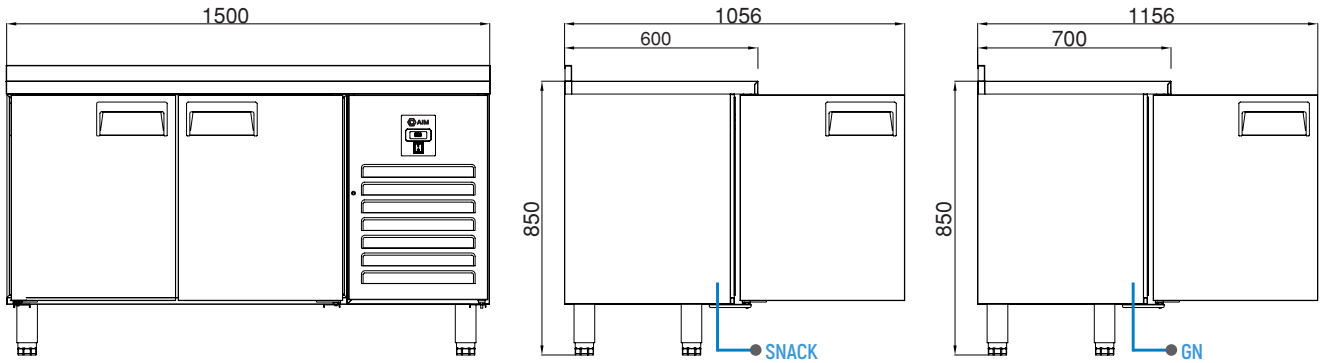

OPSİYONLAR / OPTIONS

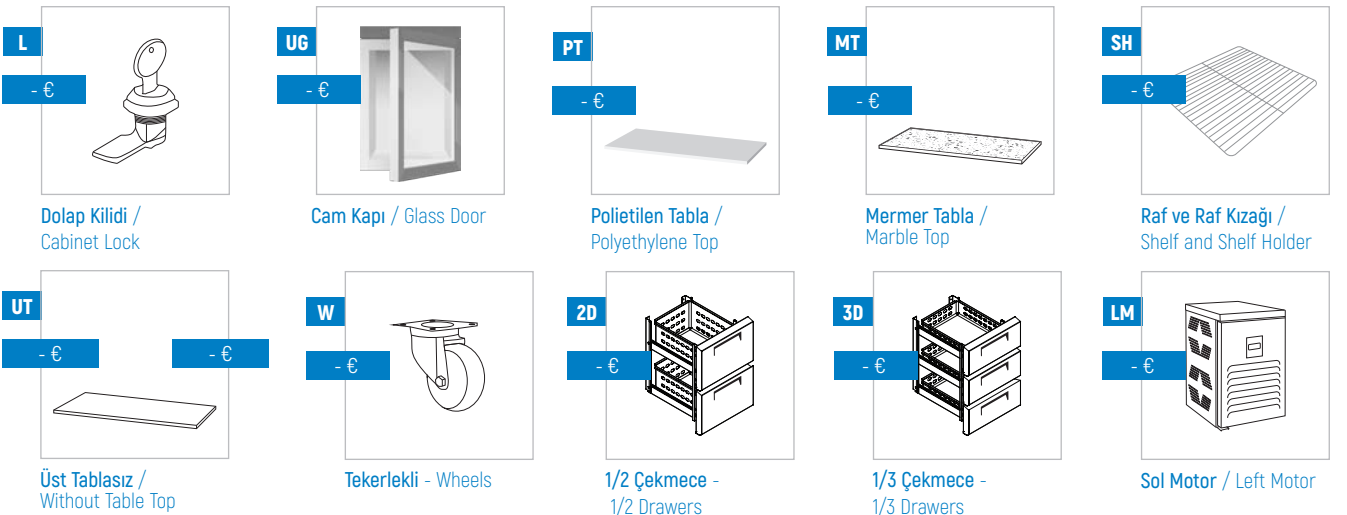

AIM

AIM 156G-157G

TEZGAH TİP BUZDOLAPLARI - 2 CAM KAPILI
COUNTER TYPE REFRIGERATORS - W/2 GLASS DOORS



KOD / CODE	°C	↑ ↓ (MM)	lit	⏻	kg	⚡ (KW)	❄️	PASLANMAZ TİPİ S.S. TYPE	€
AIM 156R3-G	-2 / +8	1500x600x850	275	230V - 50Hz	146	0,40	R134A	304	-
AIM 156R4-G	-2 / +8	1500x600x850	275	230V - 50Hz	146	0,40	R134A	430	-
AIM 157R3-G	-2 / +8	1500x700x850	330	230V - 50Hz	155	0,40	R134A	304	-
AIM 157R4-G	-2 / +8	1500x700x850	330	230V - 50Hz	155	0,40	R134A	430	-

 R290 İstenildiği takdirde fiyatlara %3 ilave edilir. / For R290 Refrigerant gas, price increase is 3%.

TEKNİK DETAYLAR / TECHNICAL DETAILS

TR

- Dış ortam sıcaklığı +43°C %65 nem oranı
- Eşit sıcaklık dağılımı için yeni tasarım
- Sıfır ODP enjekte 42 kg/m³ çevre dostu poliüretan izolasyon
- Kolay okunur ekranlı dijital kontrol
- Ergonomik kapı ve kulpu sayesinde kolay açılma ve temizlik
- Patentli 'Icecool' soğutma sistemi ile mükemmel verim ve enerji sarfıyatı
- Sıcak gaz defrost sistemi
- Atık ısı geri kazanımlı kondanzasyon
- Tüm buzdolapların marine versiyonları mevcuttur.

EN

- Designed to operate in 43°C ambient %65 humidity
- New design for equal temperature distribution
- Zero ODP Injected 42 kg/m³ Polyurethane Insulation
- Digital controller with easy read screen
- Ergonomic door and handle designed for ease of opening and cleaning
- Icecool refrigeration system designed to be most technologically advanced and energy efficient yet
- Hot gas defrost system
- Waste heat recovery condensate vaporiser system
- All refrigerators can be produced in marine version

AIM 156G-157G

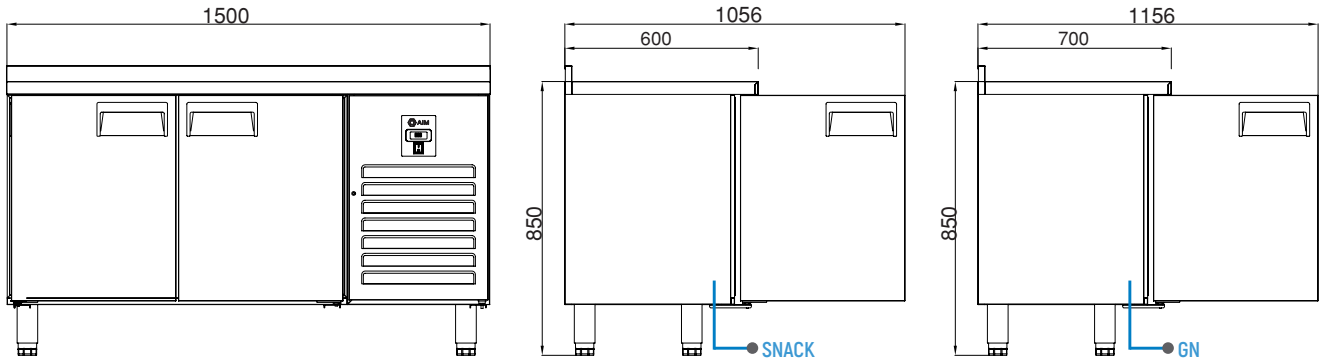

OPSİYONLAR / OPTIONS

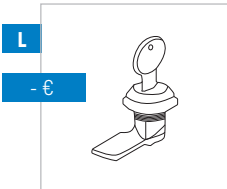

L
- €
Dolap Kilidi /
Cabinet Lock

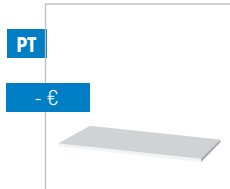

PT
- €
Polietilen Tabla /
Polyethylene Top

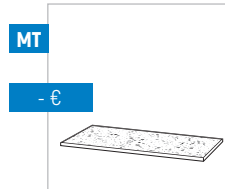

MT
- €
Mermer Tabla /
Marble Top

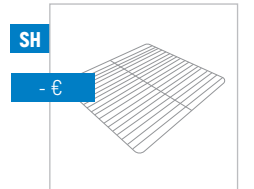

SH
- €
Raf ve Raf Kızağı /
Shelf and Shelf Holder

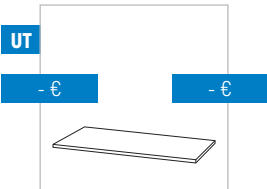

UT
- € - €
Üst Tablasız /
Without Table Top

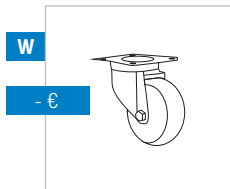

W
- €
Tekerlekli - Wheels

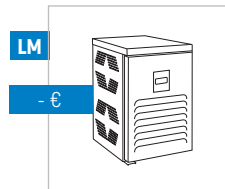

LM
- €
Sol Motor / Left Motor

AIM

AIM 206-207

TEZGAH TİP BUZDOLAPLARI - 3 KAPILI
COUNTER TYPE REFRIGERATORS - W/3 DOORS



1/2 ÇEKMECE
1/2 DRAWERS



KOD / CODE	°C	↑ ↓ (MM)	lt	⏻	kg	⚡ (KW)	❄️	PASLANMAZ TİPİ S.S. TYPE	€
AIM 206R3	-2 / +8	2000x600x850	440	230V - 50Hz	127	0,40	R134A	304	-
AIM 206R4	-2 / +8	2000x600x850	440	230V - 50Hz	127	0,40	R134A	430	-
AIM 206F3	-10 / -22	2000x600x850	440	230V - 50Hz	127	0,75	R404A	304	-
AIM 206F4	-10 / -22	2000x600x850	440	230V - 50Hz	127	0,75	R404A	430	-
AIM 207R3	-2 / +8	2000x700x850	515	230V - 50Hz	135	0,40	R134A	304	-
AIM 207R4	-2 / +8	2000x700x850	515	230V - 50Hz	135	0,40	R134A	430	-
AIM 207F3	-10 / -22	2000x700x850	515	230V - 50Hz	135	0,75	R404A	304	-
AIM 207F4	-10 / -22	2000x700x850	515	230V - 50Hz	135	0,75	R404A	430	-

R290  R290 İstenildiği takdirde fiyatlara %3 ilave edilir. / For R290 Refrigerant gas, price increase is 3%.

TEKNİK DETAYLAR / TECHNICAL DETAILS

TR

- Dış ortam sıcaklığı +43°C %65 nem oranı
- Eşit sıcaklık dağılımı için yeni tasarım
- Sıfır ODP enjekte 42 kg/m³ çevre dostu poliüretan izolasyon
- Kolay okunur ekranlı dijital kontrol
- Ergonomik kapı ve kulpu sayesinde kolay açılma ve temizlik
- Patentli 'Icecool' soğutma sistemi ile mükemmel verim ve enerji sarfıyatı
- Sıcak gaz defrost sistemi
- Atık ısı geri kazanımlı kondanzasyon
- Tüm buzdolapların marine versiyonları mevcuttur.
- **1/2 Çekmece için; 1/1-150mm Gn kapasitesi.**
- **1/3 Çekmece için; 1/1-100mm Gn kapasitesi.**

EN

- Designed to operate in 43°C ambient %65 humidity
- New design for equal temperature distribution
- Zero ODP Injected 42 kg/m³ Polyurethane Insulation
- Digital controller with easy read screen
- Ergonomic door and handle designed for ease of opening and cleaning
- Icecool refrigeration system designed to be most technologically advanced and energy efficient yet
- Hot gas defrost system
- Waste heat recovery condensate vaporiser system
- All refrigerators can be produced in marine version
- **For 1/2 drawers; 1/1-150mm Gn capacity**
- **For 1/3 drawers; 1/1-100mm Gn capacity**

AIM 206-207

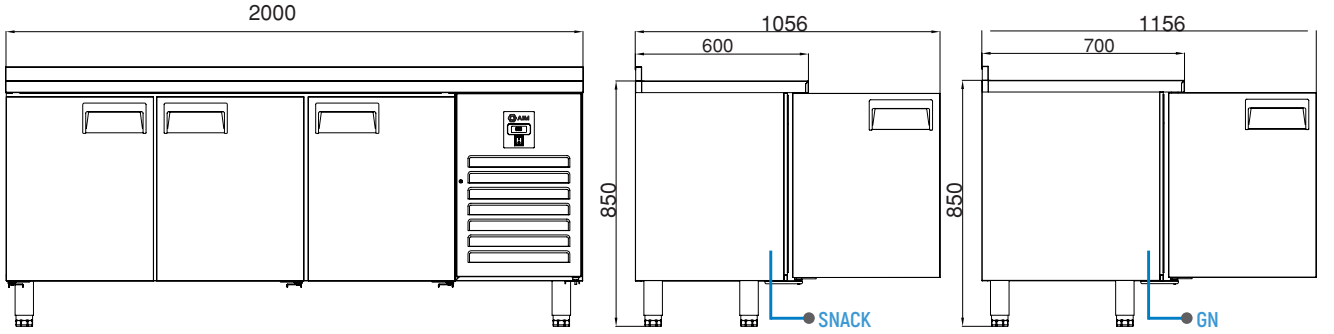

OPSİYONLAR / OPTIONS

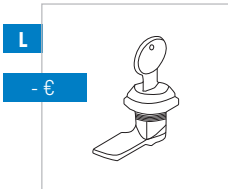

L
- €
Dolap Kilidi /
Cabinet Lock



UG
- €
Cam Kapı / Glass Door

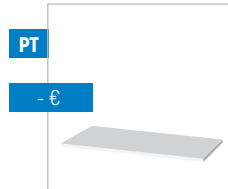

PT
- €
Poliyeten Tabla /
Polyethylene Top

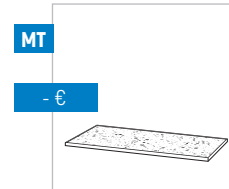

MT
- €
Mermer Tabla /
Marble Top

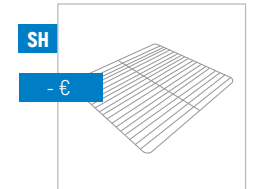

SH
- €
Raf ve Raf Kızağı /
Shelf and Shelf Holder

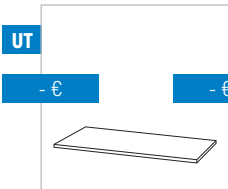

UT
- €
Üst Tablasız /
Without Table Top

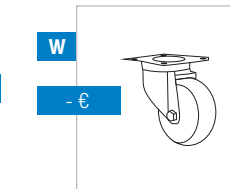

W
- €
Tekerlekli - Wheels

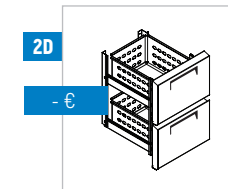

2D
- €
1/2 Çekmece -
1/2 Drawers

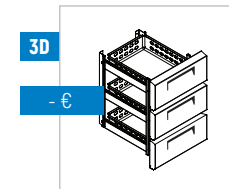

3D
- €
1/3 Çekmece -
1/3 Drawers

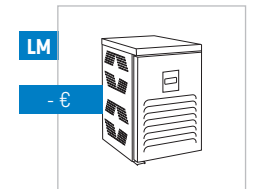

LM
- €
Sol Motor / Left Motor

AIM

AIM 206G-207G

TEZGAH TİP BUZDOLAPLARI - 3 CAM KAPILI
COUNTER TYPE REFRIGERATORS - W/3 GLASS DOORS



KOD / CODE	°C	(MM)	lt	⏻	kg	(KW)	❄️	PASLANMAZ TİPİ S.S. TYPE	€
AIM 206R3-G	-2 / +8	2000x600x850	440	230V - 50Hz	146	0,40	R134A	304	-
AIM 206R4-G	-2 / +8	2000x600x850	440	230V - 50Hz	146	0,40	R134A	430	-
AIM 207R3-G	-2 / +8	2000x700x850	515	230V - 50Hz	155	0,40	R134A	304	-
AIM 207R4-G	-2 / +8	2000x700x850	515	230V - 50Hz	155	0,40	R134A	430	-

 R290 İstenildiği takdirde fiyatlara %3 ilave edilir. / For R290 Refrigerant gas, price increase is 3%.

TEKNİK DETAYLAR / TECHNICAL DETAILS

TR

- Dış ortam sıcaklığı +43°C %65 nem oranı
- Eşit sıcaklık dağılımı için yeni tasarım
- Sıfır ODP enjekte 42 kg/m³ çevre dostu poliüretan izolasyon
- Kolay okunur ekranlı dijital kontrol
- Ergonomik kapı ve kulpu sayesinde kolay açılma ve temizlik
- Patentli 'Icecool' soğutma sistemi ile mükemmel verim ve enerji sarfıyatı
- Sıcak gaz defrost sistemi
- Atık ısı geri kazanımlı kondanzasyon
- Tüm buzdolapların marine versiyonları mevcuttur.

EN

- Designed to operate in 43°C ambient %65 humidity
- New design for equal temperature distribution
- Zero ODP Injected 42 kg/m³ Polyurethane Insulation
- Digital controller with easy read screen
- Ergonomic door and handle designed for ease of opening and cleaning Icecool refrigeration system designed to be most technologically advanced and energy efficient yet
- Hot gas defrost system
- Waste heat recovery condensate vaporiser system
- All refrigerators can be produced in marine version

AIM 206G-207G

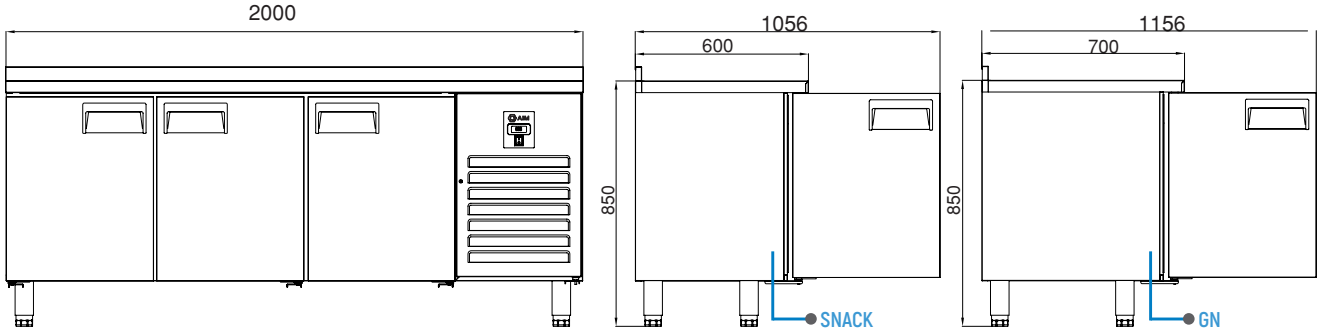

OPSİYONLAR / OPTIONS

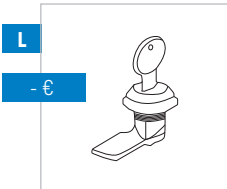

L
- €
Dolap Kilidi /
Cabinet Lock

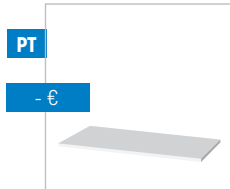

PT
- €
Poliyeten Tabla /
Polyethylene Top

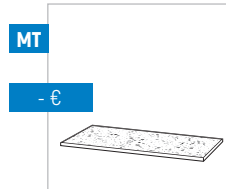

MT
- €
Mermer Tabla /
Marble Top

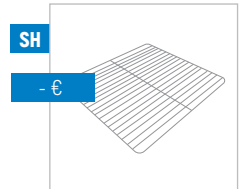

SH
- €
Raf ve Raf Kızağı /
Shelf and Shelf Holder

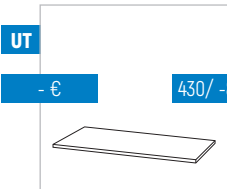

UT
- €
430/-80 €
Üst Tablasız /
Without Table Top

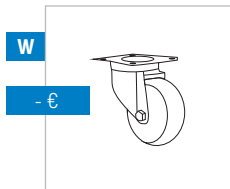

W
- €
Tekerlekli - Wheels

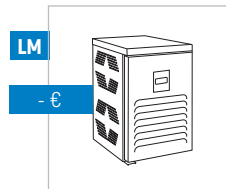

LM
- €
Sol Motor / Left Motor

AIM

AIM 256-257

TEZGAH TİP BUZDOLAPLARI - 4 KAPILI
COUNTER TYPE REFRIGERATORS - W/4 DOORS

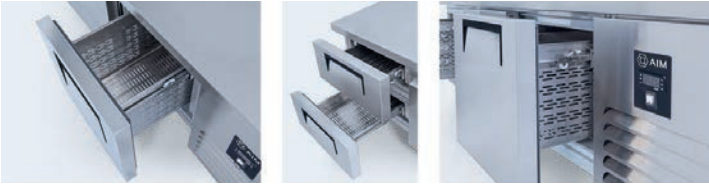

KOD / CODE	°C	(MM)	lit	⏻	kg	(KW)	❄️	PASLANMAZ TİPİ S.S. TYPE	€
AIM 256R3	-2 / +8	2500x600x850	560	230V - 50Hz	187	0,50	R134A	304	-
AIM 256R4	-2 / +8	2500x600x850	560	230V - 50Hz	187	0,50	R134A	430	-
AIM 256F3	-10 / -22	2500x600x850	560	230V - 50Hz	187	0,82	R404A	304	-
AIM 256F4	-10 / -22	2500x600x850	560	230V - 50Hz	187	0,82	R404A	430	-
AIM 257R3	-2 / +8	2500x700x850	650	230V - 50Hz	195	0,50	R134A	304	-
AIM 257R4	-2 / +8	2500x700x850	650	230V - 50Hz	195	0,50	R134A	430	-
AIM 257F3	-10 / -22	2500x700x850	650	230V - 50Hz	195	0,82	R404A	304	-
AIM 257F4	-10 / -22	2500x700x850	650	230V - 50Hz	195	0,82	R404A	430	-

 R290 İstenildiği takdirde fiyatlara %3 ilave edilir. / For R290 Refrigerant gas, price increase is 3%.

TEKNİK DETAYLAR / TECHNICAL DETAILS

TR

- Dış ortam sıcaklığı +43°C %65 nem oranı
- Eşit sıcaklık dağılımı için yeni tasarım
- Sıfır ODP enjekte 42 kg/m³ çevre dostu poliüretan izolasyon
- Kolay okunur ekranlı dijital kontrol
- Ergonomik kapı ve kulpu sayesinde kolay açılma ve temizlik
- Patentli 'Icecool' soğutma sistemi ile mükemmel verim ve enerji sarfiyatı
- Sıcak gaz defrost sistemi
- Atık ısı geri kazanımlı kondanzasyon
- Tüm buzdolapların marine versiyonları mevcuttur.
- **1/2 Çekmece için; 1/1-150mm Gn kapasitesi.**
- **1/3 Çekmece için; 1/1-100mm Gn kapasitesi.**

EN

- Designed to operate in 43°C ambient %65 humidity
- New design for equal temperature distribution
- Zero ODP Injected 42 kg/m³ Polyurethane Insulation
- Digital controller with easy read screen
- Ergonomic door and handle designed for ease of opening and cleaning
- Icecool refrigeration system designed to be most technologically advanced and energy efficient yet
- Hot gas defrost system
- Waste heat recovery condensate vaporiser system
- All refrigerators can be produced in marine version
- **For 1/2 drawers; 1/1-150mm Gn capacity**
- **For 1/3 drawers; 1/1-100mm Gn capacity**

AIM 256-257

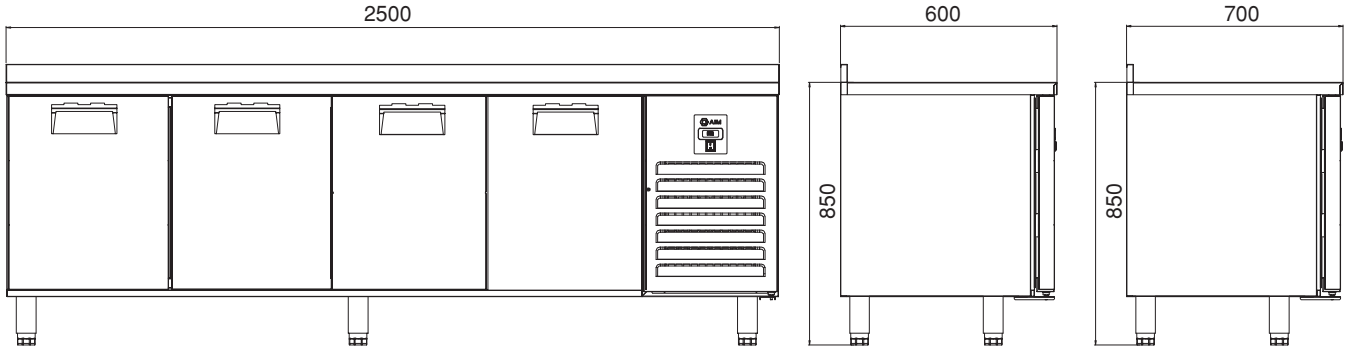

OPSİYONLAR / OPTIONS

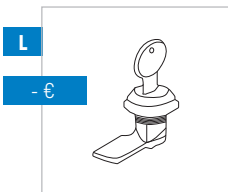

L
- €
Dolap Kilidi /
Cabinet Lock



UG
- €
Cam Kapı / Glass Door

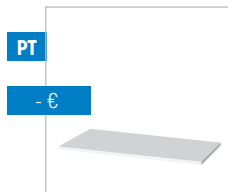

PT
- €
Poliyeten Tabla /
Polyethylene Top

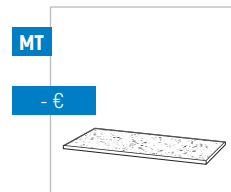

MT
- €
Mermer Tabla /
Marble Top

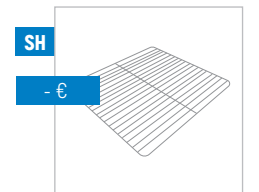

SH
- €
Raf ve Raf Kızağı /
Shelf and Shelf Holder

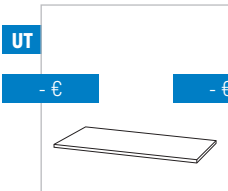

UT
- €
Üst Tablasız /
Without Table Top

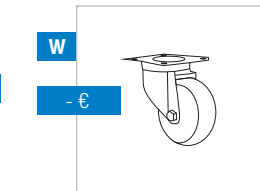

W
- €
Tekerlekli - Wheels

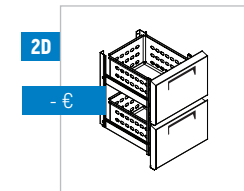

2D
- €
1/2 Çekmece -
1/2 Drawers

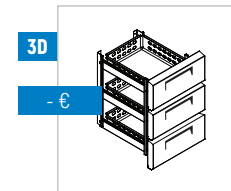

3D
- €
1/3 Çekmece -
1/3 Drawers

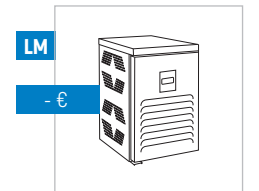

LM
- €
Sol Motor / Left Motor

AIM

AIM 256G-257G

TEZGAH TİP BUZDOLAPLARI - 4 CAM KAPILI
COUNTER TYPE REFRIGERATORS - W/4 GLASS DOORS



KOD / CODE	°C	(MM)	lt	⏻	kg	(KW)	❄️	PASLANMAZ TİPİ S.S. TYPE	€
AIM 256R3-G	-2 / +8	2500x600x850	560	230V - 50Hz	210	0,50	R134A	304	-
AIM 256R4-G	-2 / +8	2500x600x850	560	230V - 50Hz	210	0,50	R134A	430	-
AIM 257R3-G	-2 / +8	2500x700x850	650	230V - 50Hz	224	0,50	R134A	304	-
AIM 257R4-G	-2 / +8	2500x700x850	650	230V - 50Hz	224	0,50	R134A	430	-

 R290 İstenildiği takdirde fiyatlara %3 ilave edilir. / For R290 Refrigerant gas, price increase is 3%.

TEKNİK DETAYLAR / TECHNICAL DETAILS

TR

- Dış ortam sıcaklığı +43°C %65 nem oranı
- Eşit sıcaklık dağılımı için yeni tasarım
- Sıfır ODP enjekte 42 kg/m³ çevre dostu poliüretan izolasyon
- Kolay okunur ekranlı dijital kontrol
- Ergonomik kapı ve kulpu sayesinde kolay açılma ve temizlik
- Patentli 'Icecool' soğutma sistemi ile mükemmel verim ve enerji sarfiyatı
- Sıcak gaz defrost sistemi
- Atık ısı geri kazanımlı kondanzasyon
- Tüm buzdolapların marine versiyonları mevcuttur.

EN

- Designed to operate in 43°C ambient %65 humidity
- New design for equal temperature distribution
- Zero ODP Injected 42 kg/m³ Polyurethane Insulation
- Digital controller with easy read screen
- Ergonomic door and handle designed for ease of opening and cleaning
- Icecool refrigeration system designed to be most technologically advanced and energy efficient yet
- Hot gas defrost system
- Waste heat recovery condensate vaporiser system
- All refrigerators can be produced in marine version

AIM 256G-257G

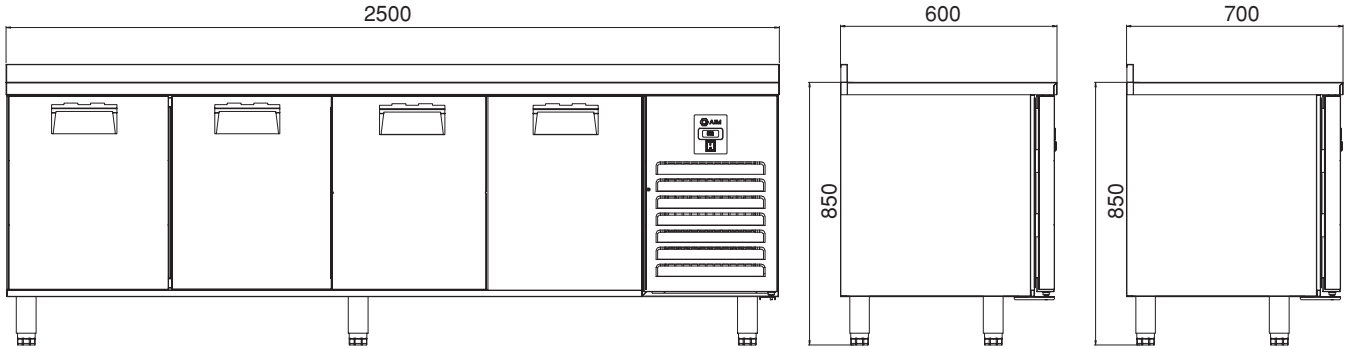

OPSİYONLAR / OPTIONS

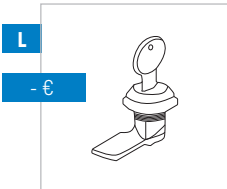

Dolap Kilidi /
Cabinet Lock

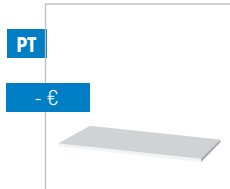

Polietilen Tabla /
Polyethylene Top

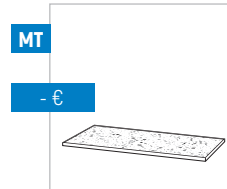

Mermer Tabla /
Marble Top

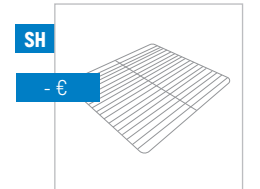

Raf ve Raf Kızağı /
Shelf and Shelf Holder

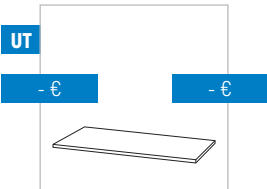

Üst Tablasız /
Without Table Top

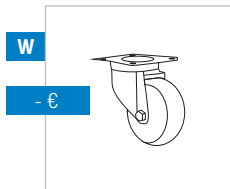

Tekerlekli - Wheels

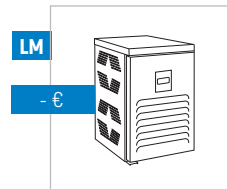

Sol Motor / Left Motor

AIM

AIM 126-127

TEZGAH TİP BUZDOLAPLARI - KISA MODEL
COUNTER TYPE REFRIGERATORS - SHORT



KOD / CODE	°C	↑ ↓ (MM)	lit	⏻	kg	⚡ (KW)	❄️	PASLANMAZ TİPİ S.S. TYPE	€
AIM 126R3	-2 / +8	1250x600x850	275	230V - 50Hz	95	0,32	R134A	304	-
AIM 126R4	-2 / +8	1250x600x850	275	230V - 50Hz	95	0,32	R134A	430	-
AIM 127R3	-2 / +8	1250x700x850	330	230V - 50Hz	100	0,32	R134A	304	-
AIM 127R4	-2 / +8	1250x700x850	330	230V - 50Hz	100	0,32	R134A	430	-
AIM 186R3	-2 / +8	1800x600x850	440	230V - 50Hz	127	0,34	R134A	304	-
AIM 186R4	-2 / +8	1800x600x850	440	230V - 50Hz	127	0,34	R134A	430	-
AIM 187R3	-2 / +8	1800x700x850	515	230V - 50Hz	135	0,34	R134A	304	-
AIM 187R4	-2 / +8	1800x700x850	515	230V - 50Hz	135	0,34	R134A	430	-
AIM 236R3	-2 / +8	2300x600x850	560	230V - 50Hz	187	0,50	R134A	304	-
AIM 236R4	-2 / +8	2300x600x850	560	230V - 50Hz	187	0,50	R134A	430	-
AIM 237R3	-2 / +8	2300x700x850	650	230V - 50Hz	195	0,50	R134A	304	-
AIM 237R4	-2 / +8	2300x700x850	650	230V - 50Hz	195	0,50	R134A	430	-

 R290 İstenildiği takdirde fiyatlara %3 ilave edilir. / For R290 Refrigerant gas, price increase is 3%.

TEKNİK DETAYLAR / TECHNICAL DETAILS

TR

- Dış ortam sıcaklığı +43°C %65 nem oranı
- Eşit sıcaklık dağılımı için yeni tasarım
- Sıfır ODP enjekte 42 kg/m³ çevre dostu poliüretan izolasyon
- Kolay okunur ekranlı dijital kontrol
- Ergonomik kapı ve kulpu sayesinde kolay açılma ve temizlik
- Patentli 'Icecool' soğutma sistemi ile mükemmel verim ve enerji sarfiyatı
- Sıcak gaz defrost sistemi
- Atık ısı geri kazanımlı kondanzasyon
- Tüm buzdolapların marine versiyonları mevcuttur.
- **1/2 Çekmece için; 1/1-150mm Gn kapasitesi.**
- **1/3 Çekmece için; 1/1-100mm Gn kapasitesi.**

EN

- Designed to operate in 43°C ambient %65 humidity
- New design for equal temperature distribution
- Zero ODP Injected 42 kg/m³ Polyurethane Insulation
- Digital controller with easy read screen
- Ergonomic door and handle designed for ease of opening and cleaning
- Icecool refrigeration system designed to be most technologically advanced and energy efficient yet
- Hot gas defrost system
- Waste heat recovery condensate vaporiser system
- All refrigerators can be produced in marine version
- **For 1/2 drawers; 1/1-150mm Gn capacity**
- **For 1/3 drawers; 1/1-100mm Gn capacity**

AIM 126-127

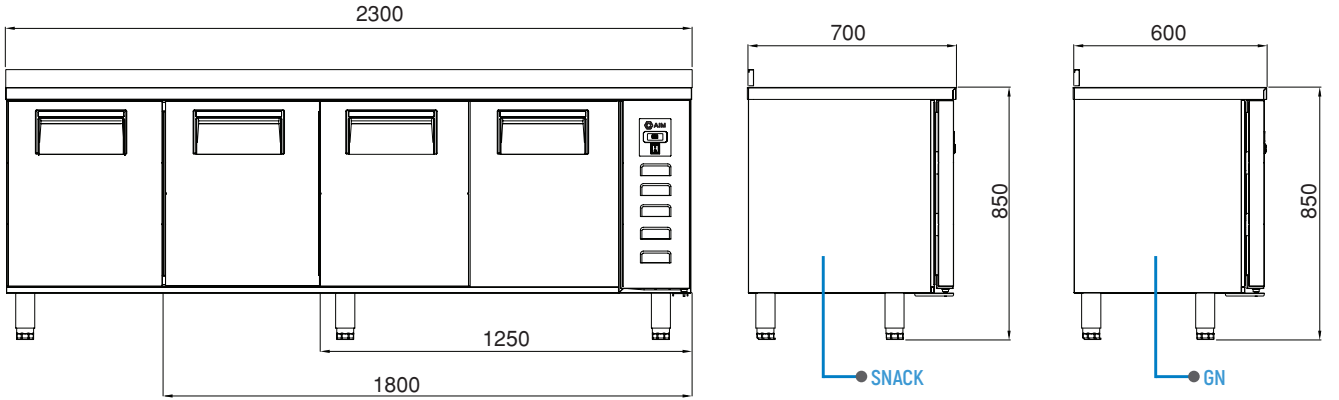

OPSİYONLAR / OPTIONS

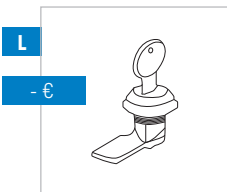

L
- €
Dolap Kilidi /
Cabinet Lock

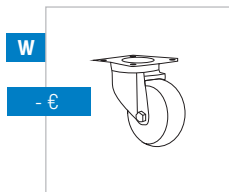

W
- €
Tekerlekli - Wheels

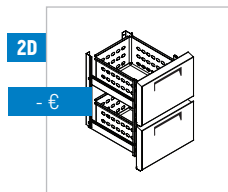

2D
- €
1/2 Çekmece -
1/2 Drawers

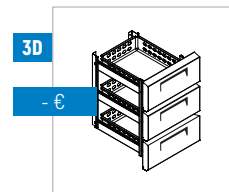

3D
- €
1/3 Çekmece -
1/3 Drawers

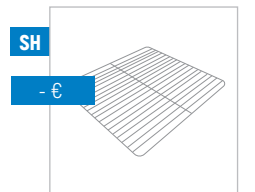

SH
- €
Raf ve Raf Kızağı /
Shelf and Shelf Holder

	2 KAPILI / 2 DOORS	3 KAPILI / 3 DOORS	4 KAPILI / 4 DOORS
ÜST TABLASIZ / WITHOUT TABLE TOP	- €	- €	- €
POLIETİLEN TABLA / POLYETHYLENE TOP	- €	- €	- €
MERMER TABLA / MARBLE TOP	- €	- €	- €

AIM

AIM 156S-157S

TEZGAH TİP EYVELİ BUZDOLABI - EYVELİ
COUNTER TYPE REFRIGERATORS - WITH SINK UNIT



KOD / CODE	°C	(MM)	lit	Power	kg	(KW)	R	PASLANMAZ TİPİ S.S. TYPE	€
AIM 156R3-S	-2 / +8	1500x600x850	275	230V - 50Hz	95	0,32	R134A	304	-
AIM 156R4-S	-2 / +8	1500x600x850	275	230V - 50Hz	95	0,32	R134A	430	-
AIM 157R3-S	-2 / +8	1500x700x850	330	230V - 50Hz	100	0,32	R404A	304	-
AIM 157R4-S	-2 / +8	1500x700x850	330	230V - 50Hz	100	0,32	R404A	430	-
AIM 206R3-S	-2 / +8	2000x600x850	440	230V - 50Hz	127	0,36	R134A	304	-
AIM 206R4-S	-2 / +8	2000x600x850	440	230V - 50Hz	127	0,36	R134A	430	-
AIM 207R3-S	-2 / +8	2000x700x850	510	230V - 50Hz	135	0,36	R404A	304	-
AIM 207R4-S	-2 / +8	2000x700x850	515	230V - 50Hz	135	0,36	R134A	430	-
AIM 256R3-S	-2 / +8	2500x600x850	560	230V - 50Hz	187	0,63	R404A	304	-
AIM 256R4-S	-2 / +8	2500x600x850	560	230V - 50Hz	187	0,63	R134A	430	-
AIM 257R3-S	-2 / +8	2500x700x850	650	230V - 50Hz	195	0,63	R404A	304	-
AIM 257R4-S	-2 / +8	2500x700x850	650	230V - 50Hz	195	0,63	R404A	430	-

R290 İstenildiği takdirde fiyatlara %3 ilave edilir. / For R290 Refrigerant gas, price increase is 3%.

TEKNİK DETAYLAR / TECHNICAL DETAILS

TR

- Dış ortam sıcaklığı +43°C %65 nem oranı
- Eşit sıcaklık dağılımı için yeni tasarım
- Sıfır ODP enjekte 42 kg/m³ çevre dostu poliüretan izolasyon
- Kolay okunur ekranlı dijital kontrol
- Ergonomik kapı ve kulpu sayesinde kolay açılma ve temizlik
- Patentli 'Icecool' soğutma sistemi ile mükemmel verim ve enerji sarfiyatı
- Sıcak gaz defrost sistemi
- Atık ısı geri kazanımlı kondanzasyon
- Tüm buzdolapların marine versiyonları mevcuttur.
- **1/2 Çekmece için; 1/1-150mm Gn kapasitesi.**
- **1/3 Çekmece için; 1/1-100mm Gn kapasitesi.**

EN

- Designed to operate in 43°C ambient %65 humidity
- New design for equal temperature distribution
- Zero ODP Injected 42 kg/m³ Polyurethane Insulation
- Digital controller with easy read screen
- Ergonomic door and handle designed for ease of opening and cleaning
- Icecool refrigeration system designed to be most technologically advanced and energy efficient yet
- Hot gas defrost system
- Waste heat recovery condensate vaporiser system
- All refrigerators can be produced in marine version
- **For 1/2 drawers; 1/1-150mm Gn capacity**
- **For 1/3 drawers; 1/1-100mm Gn capacity**

AIM 156S-157S

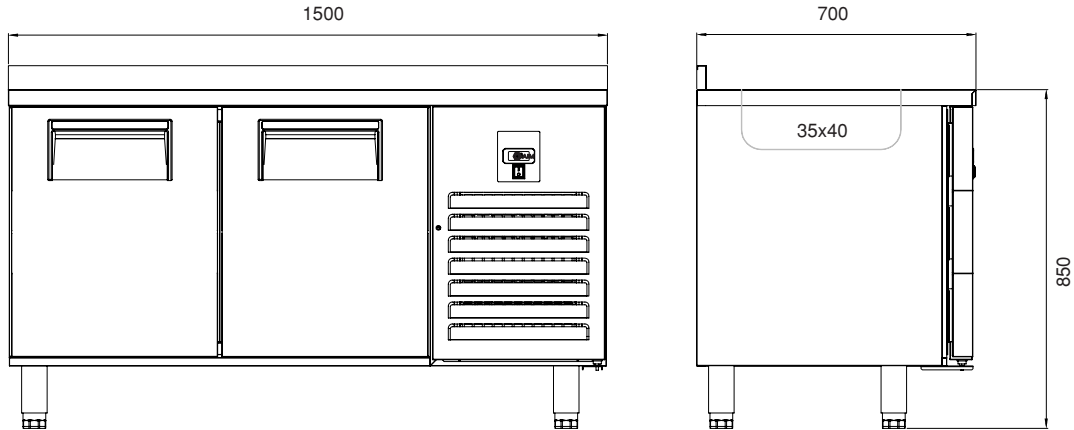

OPSİYONLAR / OPTIONS

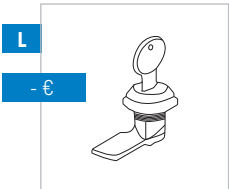

L
- €
Dolap Kilidi / Cabinet Lock



W
- €
Tekerlekli - Wheels



UG
- €
Cam Kapı / Glass Door

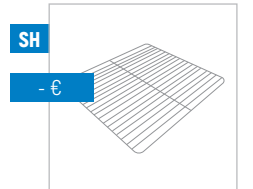

SH
- €
Raf ve Raf Kızağı / Shelf and Shelf Holder

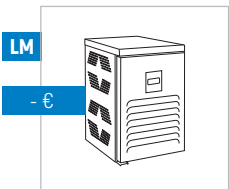

LM
- €
Sol Motor / Left Motor

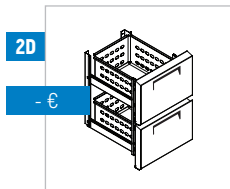

2D
- €
1/2 Çekmece - 1/2 Drawers

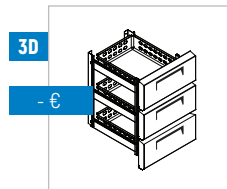

3D
- €
1/3 Çekmece - 1/3 Drawers

DİK TİP SOĞUTUCU SERİSİ

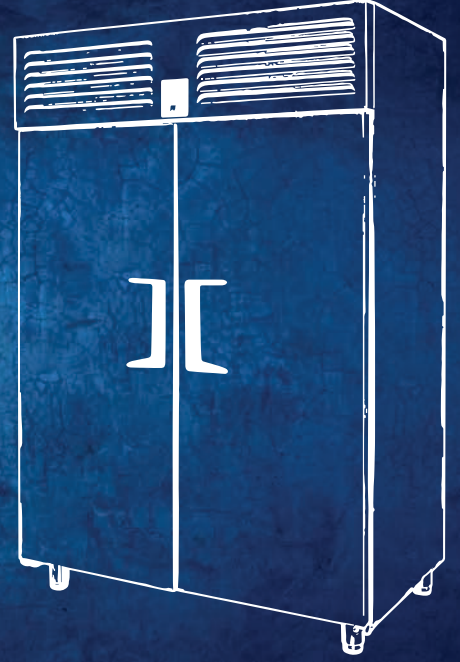

VERTICAL
TYPE
SERIES

YENİ KONDENSER SİSTEMİ NEW CONDENSER SYSTEM



CLASSIC

Temizlik gerektirmeyen kondenser
Stayclear Condenser



AIMCLEAR



Düşük enerji tüketimi sağlayan çevre dostu
HFC içermeyen poliüretan izolasyon
Eco friendly, HFC - free polyurethane insulation
providing low energy consumption

KUSURSUZ SOĞUTMA SİSTEMİ PERFECT COOLING SYSTEM



CLASSIC



AIMICE

Arka sac sayesinde her rafta homojen ısı dağılımı
Homogeneous heat distribution on each shelf thanks to custom design rear sheet

SICAK GAZ DEFOST İLE KARLANMAYAN EVAPARATÖR EVAPARATOR DOES NOT SNOW THROUGH HOT GAS DEFROST

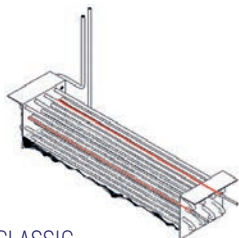

CLASSIC

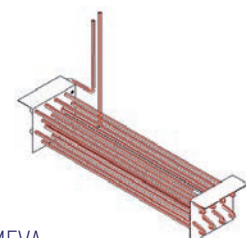

AIMEVA

AIM

AIM 40

DİKEY TİP BUZDOLAPLARI - 1 KAPILI - SLİM TİP
VERTICAL TYPE REFRIGERATORS - W/1 DOOR - SLİM TYPE

NEW PRODUCT

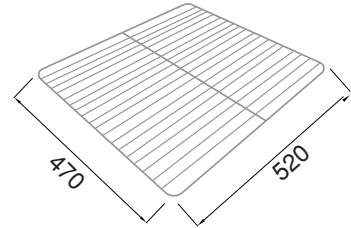
RAF ÖLÇÜSÜ /
SHELF DIMENSION

KOD / CODE	°C	↑ ↓ (MM)	lit	⏻	kg	⚡ (kW)	❄️	PASLANMAZ TİPİ S.S. TYPE	€
AIM 40SR3	-2 / +8	630x650x1995	400	230V - 50Hz	104	0,32	R134A	304	-
AIM 40SR4	-2 / +8	630x650x1995	400	230V - 50Hz	104	0,32	R134A	430	-
AIM 40SF3	-10 / -22	630x650x1995	400	230V - 50Hz	104	0,70	R404A	304	-
AIM 40SF4	-10 / -22	630x650x1995	400	230V - 50Hz	104	0,70	R404A	430	-

R290 İstenildiği takdirde fiyatlara %3 ilave edilir. / For R290 Refrigerant gas, price increase is 3%.

TEKNİK DETAYLAR / TECHNICAL DETAILS

TR

- Dış ortam sıcaklığı +43°C %65 nem oranı
- Eşit sıcaklık dağılımı için yeni tasarım
- Sıfır ODP enjekte 42 kg/m³ çevre dostu poliüretan izolasyon
- Kolay okunur ekranlı dijital kontrol
- Ergonomik kapı ve kulpu sayesinde kolay açılma ve temizlik
- Patentli 'Icecool' soğutma sistemi ile mükemmel verim ve enerji sarfiyatı
- Sıcak gaz defrost sistemi
- Atık ısı geri kazanımlı kondanzasyon
- Tüm buzdolapların marine versiyonları mevcuttur.
- Marine versiyonları 'Icecool marine' sistemi, marine ayak ve raflar içerir.

EN

- Designed to operate in 43°C ambient %65 humidity
- New design for equal temperature distribution
- Zero ODP Injected 42 kg/m³ Polyurethane Insulation
- Digital controller with easy read screen
- Ergonomic door and handle designed for ease of opening and cleaning
- Icecool refrigeration system designed to be most technologically advanced and energy efficient yet
- Hot gas defrost system
- Waste heat recovery condensate vaporiser system
- All refrigerators can be produced in marine version
- Marine version includes 'Icecool marine' system, legs and shelves

AIM 40

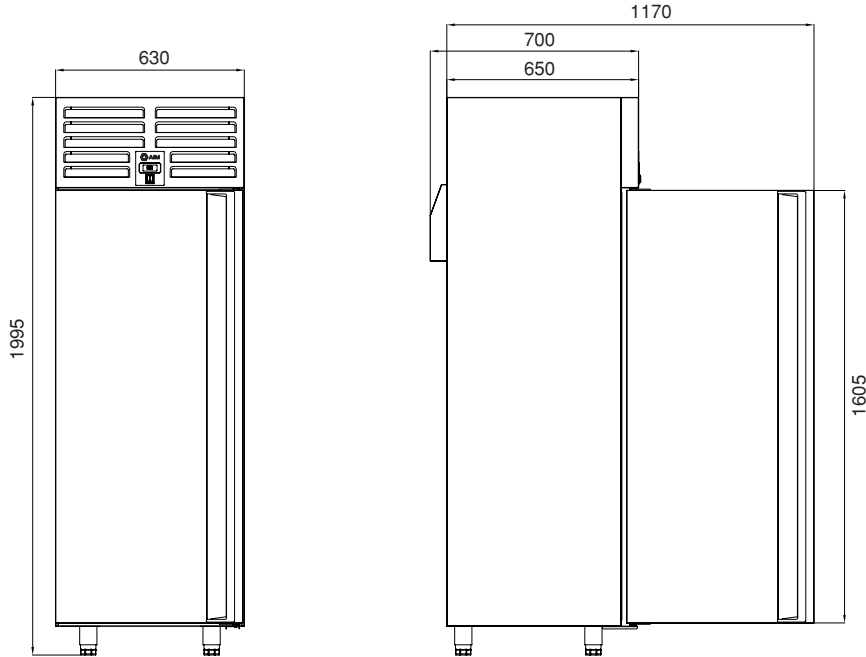

OPSIYONLAR / OPTIONS

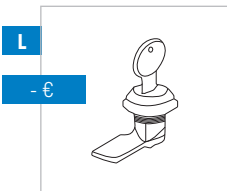

L
- €
Dolap Kilidi /
Cabinet Lock

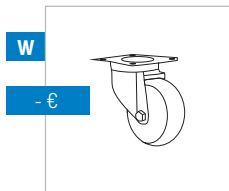

W
- €
Tekerlekli - Wheels

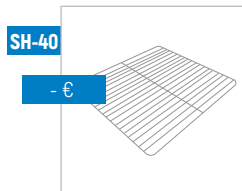

SH-40
- €
Raf ve Raf Kızağı /
Shelf and Shelf Holder

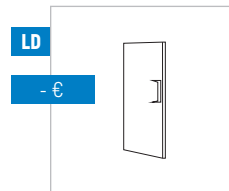

LD
- €
Sol Kapı / Left Door

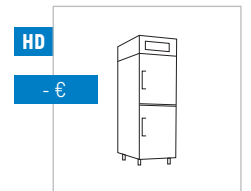

HD
- €
Yarım Kapı / Half Door

AIM

AIM 70

DİKEY TİP BUZDOLAPLARI - 1 KAPILI
VERTICAL TYPE REFRIGERATORS - W/1 DOOR

KOD / CODE	°C	↑ ↓ (MM)	lit	⏻	kg	⚡ (kW)	❄️	PASLANMAZ TİPİ S.S. TYPE	€
AIM 70SR3	-2 / +8	700x770x2100	520	230V - 50Hz	116	0,32	R134A	304	-
AIM 70SR4	-2 / +8	700x770x2100	520	230V - 50Hz	116	0,32	R134A	430	-
AIM 70SF3	-10 / -22	700x770x2100	520	230V - 50Hz	116	0,70	R404A	304	-
AIM 70SF4	-10 / -22	700x770x2100	520	230V - 50Hz	116	0,70	R404A	430	-
AIM 70GR3	-2 / +8	700x870x2100	610	230V - 50Hz	124	0,32	R134A	304	-
AIM 70GR4	-2 / +8	700x870x2100	610	230V - 50Hz	124	0,32	R134A	430	-
AIM 70GF3	-10 / -22	700x870x2100	610	230V - 50Hz	124	0,70	R404A	304	-
AIM 70GF4	-10 / -22	700x870x2100	610	230V - 50Hz	124	0,70	R404A	430	-

 R290 İstenildiği takdirde fiyatlara %3 ilave edilir. / For R290 Refrigerant gas, price increase is 3%.

TEKNİK DETAYLAR / TECHNICAL DETAILS

TR

- Dış ortam sıcaklığı +43°C %65 nem oranı
- Eşit sıcaklık dağılımı için yeni tasarım
- Sıfır ODP enjekte 42 kg/m³ çevre dostu poliüretan izolasyon
- Kolay okunur ekranlı dijital kontrol
- Ergonomik kapı ve kulpu sayesinde kolay açılma ve temizlik
- Patentli 'Icecool' soğutma sistemi ile mükemmel verim ve enerji sarfiyatı
- Sıcak gaz defrost sistemi
- Atık ısı geri kazanımlı kondanzasyon
- Tüm buzdolapların marine versiyonları mevcuttur.
- Marine versiyonları 'Icecool marine' sistemi, marine ayak ve raflar içerir.

EN

- Designed to operate in 43°C ambient %65 humidity
- New design for equal temperature distribution
- Zero ODP Injected 42 kg/m³ Polyurethane Insulation
- Digital controller with easy read screen
- Ergonomic door and handle designed for ease of opening and cleaning
- Icecool refrigeration system designed to be most technologically advanced and energy efficient yet
- Hot gas defrost system
- Waste heat recovery condensate vaporiser system
- All refrigerators can be produced in marine version
- Marine version includes 'Icecool marine' system, legs and shelves

AIM 70

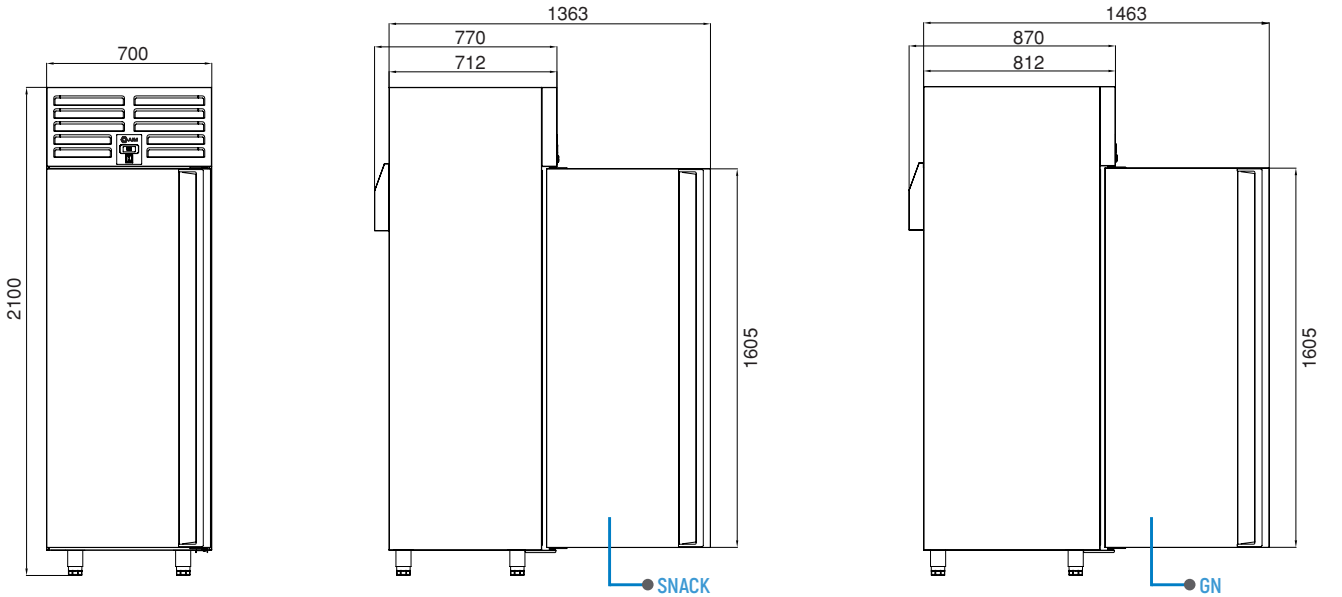

OPSIYONLAR / OPTIONS

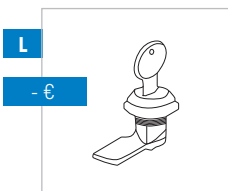

Dolap Kilidi /
Cabinet Lock

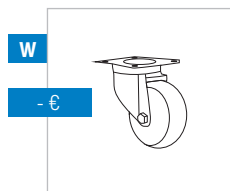

Tekerlekli - Wheels

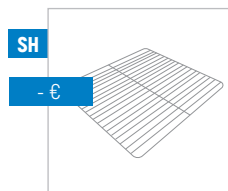

Raf ve Raf Kızağı /
Shelf and Shelf Holder

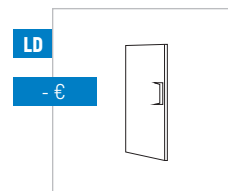

Sol Kapı / Left Door

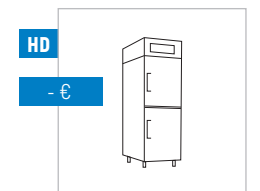

Yarım Kapı / Half Door

AIM

AIM 70G

DİKEY TİP BUZDOLAPLARI - 1 CAM KAPILI
VERTICAL TYPE REFRIGERATORS - W/1 GLASS DOOR



KOD / CODE	°C	↑ ↓ (MM)	lit	⏻	kg	⚡ (kW)	❄️	PASLANMAZ TİPİ S.S. TYPE	€
AIM 70SR3-G	-2 / +8	700x770x2100	520	230V - 50Hz	126	0,32	R134A	304	-
AIM 70SR4-G	-2 / +8	700x770x2100	520	230V - 50Hz	126	0,32	R134A	430	-
AIM 70SF3-G	-10 / -22	700x770x2100	520	230V - 50Hz	126	0,70	R404A	304	-
AIM 70SF4-G	-10 / -22	700x770x2100	520	230V - 50Hz	126	0,70	R404A	430	-
AIM 70GR3-G	-2 / +8	700x870x2100	610	230V - 50Hz	133	0,32	R134A	304	-
AIM 70GR4-G	-2 / +8	700x870x2100	610	230V - 50Hz	133	0,32	R134A	430	-
AIM 70GF3-G	-10 / -22	700x870x2100	610	230V - 50Hz	133	0,70	R404A	304	-
AIM 70GF4-G	-10 / -22	700x870x2100	610	230V - 50Hz	133	0,70	R404A	430	-

 R290 İstenildiği takdirde fiyatlara %3 ilave edilir. / For R290 Refrigerant gas, price increase is 3%.

TEKNİK DETAYLAR / TECHNICAL DETAILS

TR

- Dış ortam sıcaklığı +43°C %65 nem oranı
- Eşit sıcaklık dağılımı için yeni tasarım
- Sıfır ODP enjekte 42 kg/m³ çevre dostu poliüretan izolasyon
- Kolay okunur ekranlı dijital kontrol
- Ergonomik kapı ve kulpu sayesinde kolay açılma ve temizlik
- Patentli 'Icecool' soğutma sistemi ile mükemmel verim ve enerji sarfiyatı
- Sıcak gaz defrost sistemi
- Atık ısı geri kazanımlı kondanzasyon
- Tüm buzdolapların marine versiyonları mevcuttur.
- Marine versiyonları 'Icecool marine' sistemi, marine ayak ve raflar içerir.

EN

- Designed to operate in 43°C ambient %65 humidity
- New design for equal temperature distribution
- Zero ODP Injected 42 kg/m³ Polyurethane Insulation
- Digital controller with easy read screen
- Ergonomic door and handle designed for ease of opening and cleaning
- Icecool refrigeration system designed to be most technologically advanced and energy efficient yet
- Hot gas defrost system
- Waste heat recovery condensate vaporiser system
- All refrigerators can be produced in marine version
- Marine version includes 'Icecool marine' system, legs and shelves

AIM 70G

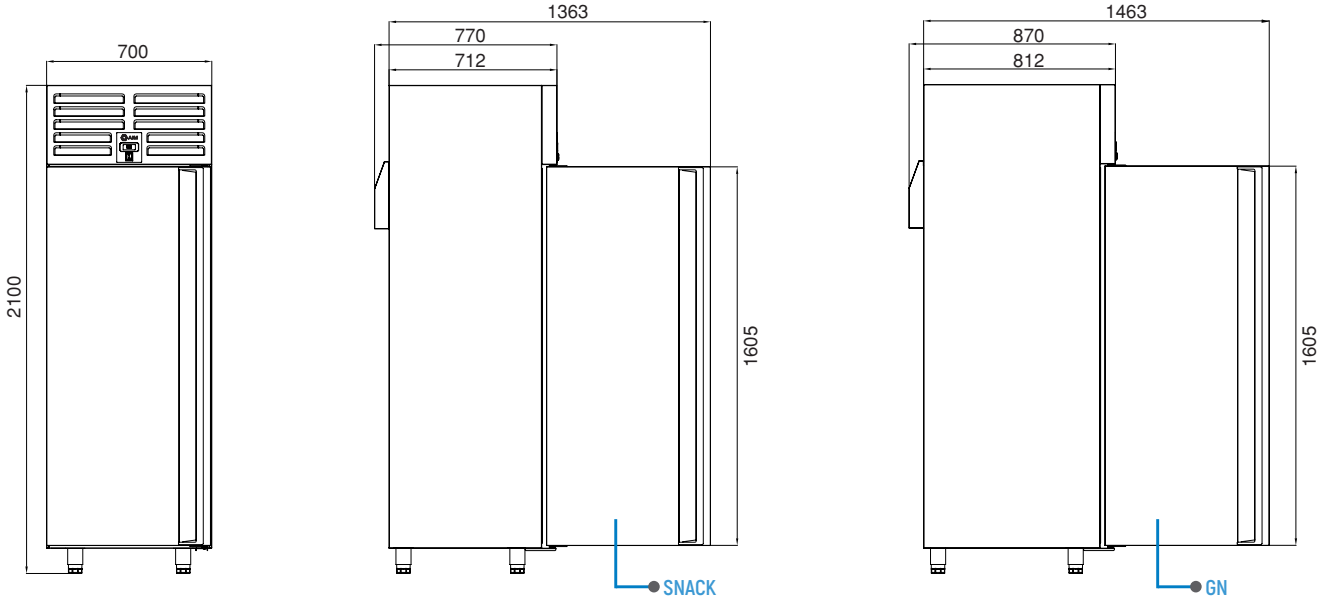

OPSIYONLAR / OPTIONS

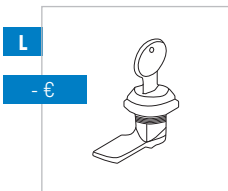

Dolap Kilidi /
Cabinet Lock

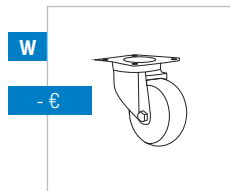

Tekerlekli - Wheels

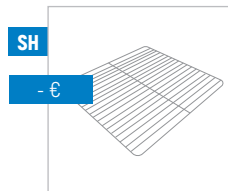

Raf ve Raf Kızağı /
Shelf and Shelf Holder

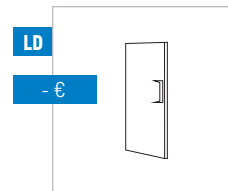

Sol Kapı / Left Door

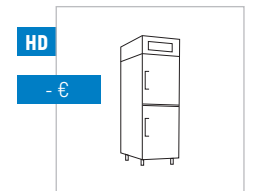

Yarım Kapı / Half Door

AIM

AIM 14

DİKEY TİP BUZDOLAPLARI - 2 KAPILI
VERTICAL TYPE REFRIGERATORS - W/2 DOORS

KOD / CODE	°C	↑ [MM]	lit	⏻	kg	⚡ (kW)	❄️	PASLANMAZ TİPİ S.S. TYPE	€
AIM 14SR3	-2 / +8	1400x770x2100	1150	230V - 50Hz	175	0,76	R134A	304	-
AIM 14SR4	-2 / +8	1400x770x2100	1150	230V - 50Hz	175	0,76	R134A	430	-
AIM 14SF3	-10 / -22	1400x770x2100	1150	230V - 50Hz	175	0,98	R404A	304	-
AIM 14SF4	-10 / -22	1400x770x2100	1150	230V - 50Hz	175	0,98	R404A	430	-
AIM 14GR3	-2 / +8	1400x870x2100	1340	230V - 50Hz	190	0,76	R134A	304	-
AIM 14GR4	-2 / +8	1400x870x2100	1340	230V - 50Hz	190	0,76	R134A	430	-
AIM 14GF3	-10 / -22	1400x870x2100	1340	230V - 50Hz	190	0,98	R404A	304	-
AIM 14GF4	-10 / -22	1400x870x2100	1340	230V - 50Hz	190	0,98	R404A	430	-

 R290 İstenildiği takdirde fiyatlara %3 ilave edilir. / For R290 Refrigerant gas, price increase is 3%.

TEKNİK DETAYLAR / TECHNICAL DETAILS

TR

- Dış ortam sıcaklığı +43°C %65 nem oranı
- Eşit sıcaklık dağılımı için yeni tasarım
- Sıfır ODP enjekte 42 kg/m³ çevre dostu poliüretan izolasyon
- Kolay okunur ekranlı dijital kontrol
- Ergonomik kapı ve kulpu sayesinde kolay açılma ve temizlik
- Patentli 'Icecool' soğutma sistemi ile mükemmel verim ve enerji sarfiyatı
- Sıcak gaz defrost sistemi
- Atık ısı geri kazanımlı kondanzasyon
- Tüm buzdolapların marine versiyonları mevcuttur.
- Marine versiyonları 'Icecool marine' sistemi, marine ayak ve raflar içerir.

EN

- Designed to operate in 43°C ambient %65 humidity
- New design for equal temperature distribution
- Zero ODP Injected 42 kg/m³ Polyurethane Insulation
- Digital controller with easy read screen
- Ergonomic door and handle designed for ease of opening and cleaning
- Icecool refrigeration system designed to be most technologically advanced and energy efficient yet
- Hot gas defrost system
- Waste heat recovery condensate vaporiser system
- All refrigerators can be produced in marine version
- Marine version includes 'Icecool marine' system, legs and shelves

AIM 14

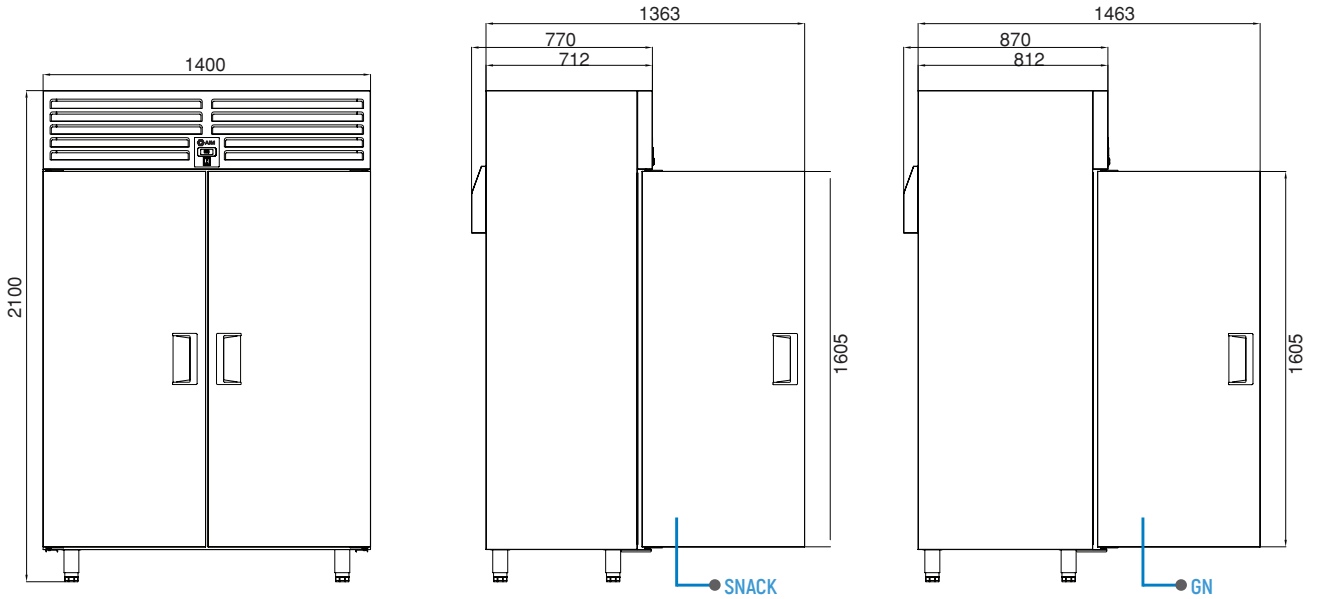

OPSIYONLAR / OPTIONS

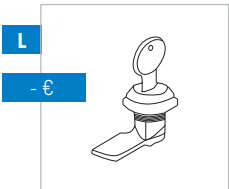

L
- €
Dolap Kilidi / Cabinet Lock



W
- €
Tekerlekli - Wheels

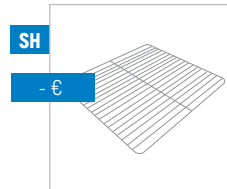

SH
- €
Raf ve Raf Kızağı /
Shelf and Shelf Holder

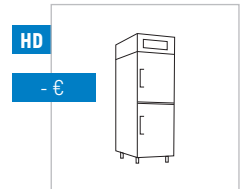

HD
- €
Yarım Kapı / Half Door

AIM

AIM 14G

DİKEY TİP BUZDOLAPLARI - 2 CAM KAPILI
VERTICAL TYPE REFRIGERATORS - W/2 GLASS DOORS



KOD / CODE	°C	↑ [MM]	lit	⏻	kg	⚡ (KW)	❄️	PASLANMAZ TİPİ S.S. TYPE	€
AIM 14SR3-G	-2 / +8	1400x770x2100	1150	230V - 50Hz	224	0,65	R134A	304	-
AIM 14SR4-G	-2 / +8	1400x770x2100	1150	230V - 50Hz	224	0,65	R134A	430	-
AIM 14SF3-G	-10 / -22	1400x770x2100	1150	230V - 50Hz	224	0,83	R404A	304	-
AIM 14SF4-G	-10 / -22	1400x700x2100	1150	230V - 50Hz	224	0,83	R404A	430	-
AIM 14GR3-G	-2 / +8	1400x870x2100	1340	230V - 50Hz	237	0,65	R134A	304	-
AIM 14GR4-G	-2 / +8	1400x870x2100	1340	230V - 50Hz	237	0,65	R134A	430	-
AIM 14GF3-G	-10 / -22	1400x870x2100	1340	230V - 50Hz	237	0,83	R404A	304	-
AIM 14GF4-G	-10 / -22	1400x870x2100	1340	230V - 50Hz	237	0,83	R404A	430	-

 R290 İstenildiği takdirde fiyatlara %3 ilave edilir. / For R290 Refrigerant gas, price increase is 3%.

TEKNİK DETAYLAR / TECHNICAL DETAILS

TR

- Dış ortam sıcaklığı +43°C %65 nem oranı
- Eşit sıcaklık dağılımı için yeni tasarım
- Sıfır ODP enjekte 42 kg/m³ çevre dostu poliüretan izolasyon
- Kolay okunur ekranlı dijital kontrol
- Ergonomik kapı ve kulpu sayesinde kolay açılma ve temizlik
- Patentli 'Icecool' soğutma sistemi ile mükemmel verim ve enerji sarfiyatı
- Sıcak gaz defrost sistemi
- Atık ısı geri kazanımlı kondanzasyon
- Tüm buzdolapların marine versiyonları mevcuttur.
- Marine versiyonları 'Icecool marine' sistemi, marine ayak ve raflar içerir.

EN

- Designed to operate in 43°C ambient %65 humidity
- New design for equal temperature distribution
- Zero ODP Injected 42 kg/m³ Polyurethane Insulation
- Digital controller with easy read screen
- Ergonomic door and handle designed for ease of opening and cleaning
- Icecool refrigeration system designed to be most technologically advanced and energy efficient yet
- Hot gas defrost system
- Waste heat recovery condensate vaporiser system
- All refrigerators can be produced in marine version
- Marine version includes 'Icecool marine' system, legs and shelves

AIM 14G

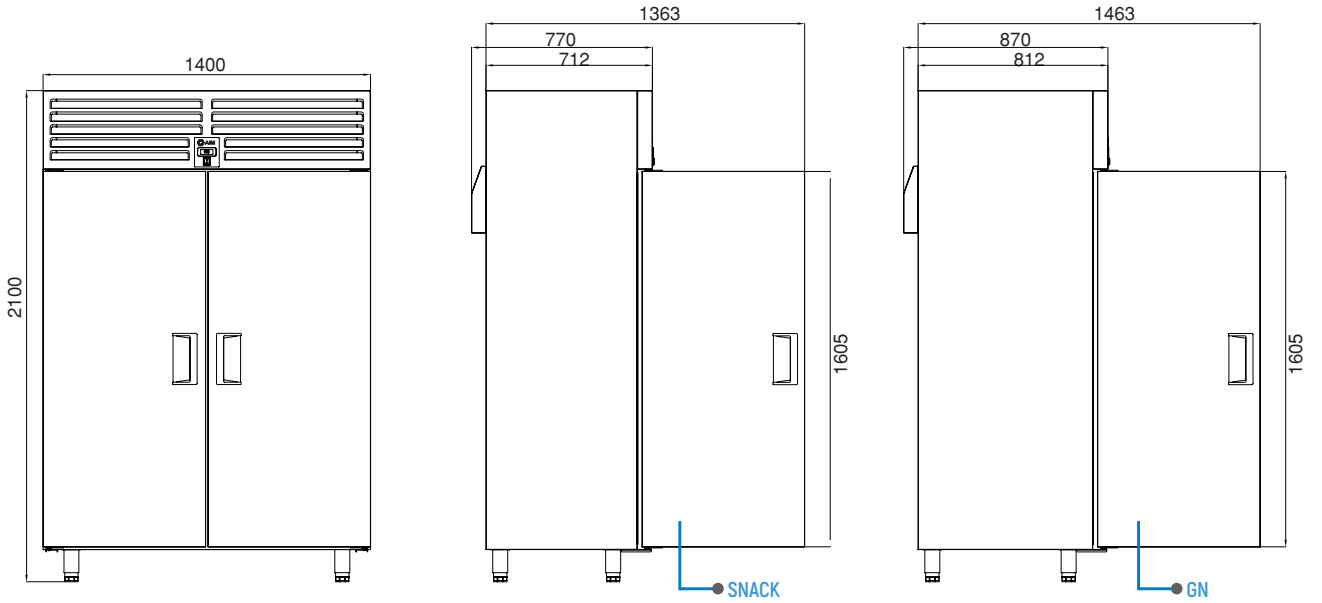

OPSIYONLAR / OPTIONS

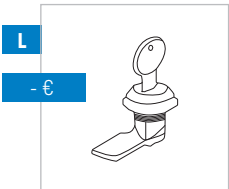

Dolap Kilidi / Cabinet Lock



Tekerlekli - Wheels

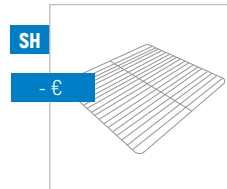

Raf ve Raf Kızağı / Shelf and Shelf Holder

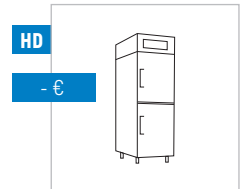

Yarım Kapı / Half Door

AIM

AIM 70 COMBI

DİKEY KOMBİ TİP BUZDOLAPLARI - 2 KAPILI
VERTICAL COMBI TYPE REFRIGERATORS - W/2 DOORS

NEW PRODUCT

-2 °C
+8 °C

-10 °C
-22 °C

KOD / CODE	°C	(MM)	lt	Power	kg	(KW)	R290	PASLANMAZ TİPİ S.S. TYPE	€
AIM 70CRF3	-2 / +8 -10 / -22	700x864x2070	610	230V - 50Hz	125	0,65	R290	304	-
AIM 70CRF4	-2 / +8 -10 / -22	700x864x2070	610	230V - 50Hz	125	0,65	R290	430	-

 R290 İstenildiği takdirde fiyatlara %3 ilave edilir. / For R290 Refrigerant gas, price increase is 3%.

TEKNİK DETAYLAR / TECHNICAL DETAILS

TR

- Dış ortam sıcaklığı +43°C %65 nem oranı
- Eşit sıcaklık dağılımı için yeni tasarım
- Sıfır ODP enjekte 42 kg/m³ çevre dostu poliüretan izolasyon
- Kolay okunur ekranlı dijital kontrol
- Ergonomik kapı ve kulpu sayesinde kolay açılma ve temizlik
- Patentli 'Icecool' soğutma sistemi ile mükemmel verim ve enerji sarfiyatı
- Sıcak gaz defrost sistemi
- Atık ısı geri kazanımlı kondanzasyon
- Tüm buzdolapların marine versiyonları mevcuttur.
- Marine versiyonları 'Icecool marine' sistemi, marine ayak ve raflar içerir.

EN

- Designed to operate in 43°C ambient %65 humidity
- New design for equal temperature distribution
- Zero ODP Injected 42 kg/m³ Polyurethane Insulation
- Digital controller with easy read screen
- Ergonomic door and handle designed for ease of opening and cleaning
- Icecool refrigeration system designed to be most technologically advanced and energy efficient yet
- Hot gas defrost system
- Waste heat recovery condensate vaporiser system
- All refrigerators can be produced in marine version
- Marine version includes 'Icecool marine' system, legs and shelves

AIM 70 COMBI

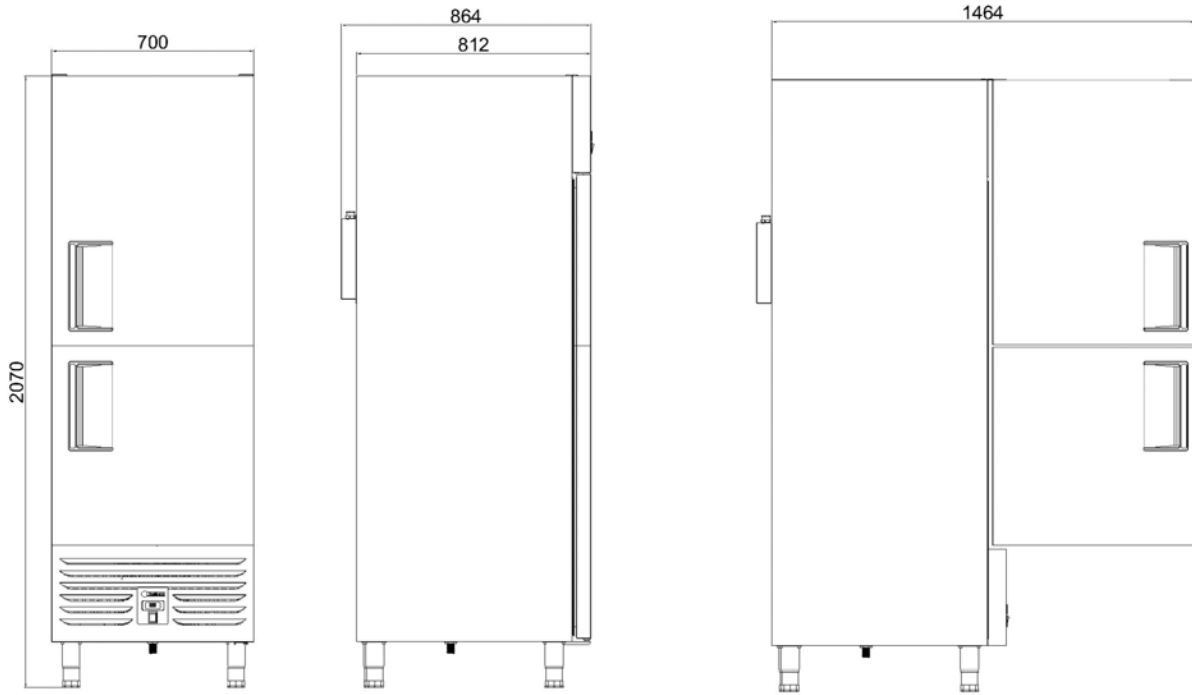

OPSİYONLAR / OPTIONS

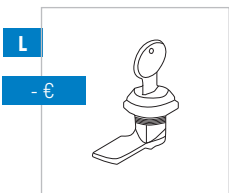

Dolap Kilidi /
Cabinet Lock

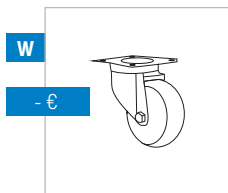

Tekerlekli - Wheels

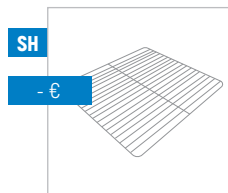

Raf ve Raf Kızağı /
Shelf and Shelf Holder

SETALTI SOĞUTUCU SERİSİ



AIM

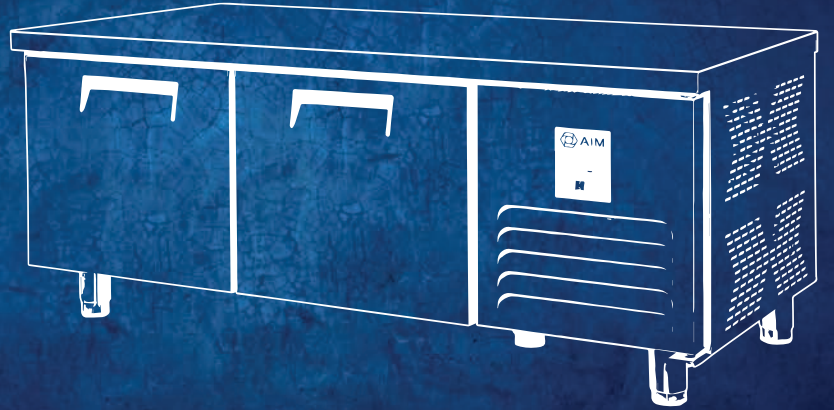

LOW LEVEL SERIES

YENİ KONDENSER SİSTEMİ NEW CONDENSER SYSTEM



CLASSIC

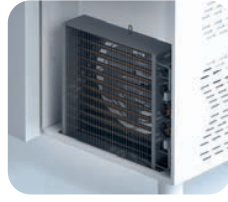

AIMCLEAR

Temizlik gerektirmeyen kondenser
Stayclear Condenser

ENERJİ TASARRUFU SAVING ENERGY



Düşük enerji tüketimi sağlayan çevre dostu
HFC içermeyen poliüretan izolasyon
Eco friendly, HFC - free polyurethane insulation
providing low energy consumption

KUSURSUZ ISI KONTROLÜ PERFECT HEAT CONTROL



CLASSIC



AIM HEAT

Set altı ek izolasyon çözümümüz ile, ısı kontrolü kusursuz şekilde sağlanır
With our under counter insulation solution, temperature control is provided perfectly

SICAK GAZ DEFROST İLE KARLANMAYAN EVAPARATÖR HOT GAS DEFROST SYSTEM PROVIDES NON-FROSTING EVAPORATOR

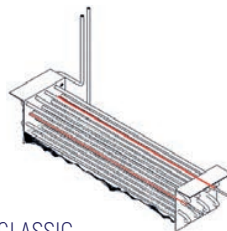

CLASSIC

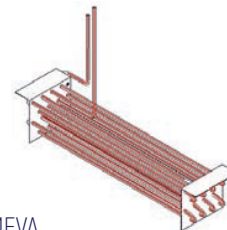

AIMEVA

AIM

AIM 146L-147L

PIŞIRICI ALTI BUZDOLAPLARI - 2 KAPILI
LOW LEVEL REFRIGERATORS - W/2 DOORS

80mm Üst Tabla İzolasyon Kalınlığı
80mm Insulation Thickness on top



1/1 Çekmece
1/1 Drawers



KOD / CODE	°C	(MM)	lt	⏻	kg	(KW)	❄️	PASLANMAZ TİPİ S.S. TYPE	€
AIM 146LR3	-2 / +8	1400x600x600	190	230V - 50Hz	90	0,32	R134A	304	-
AIM 146LR4	-2 / +8	1400x600x600	190	230V - 50Hz	90	0,32	R134A	430	-
AIM 146LF3	-10 / -22	1400x600x600	190	230V - 50Hz	90	0,68	R404A	304	-
AIM 146LF4	-10 / -22	1400x600x600	190	230V - 50Hz	90	0,68	R404A	430	-
AIM 147LR3	-2 / +8	1400x700x600	220	230V - 50Hz	95	0,32	R134A	304	-
AIM 147LR4	-2 / +8	1400x700x600	220	230V - 50Hz	95	0,32	R134A	430	-
AIM 147LF3	-10 / -22	1400x700x600	220	230V - 50Hz	95	0,68	R404A	304	-
AIM 147LF4	-10 / -22	1400x700x600	220	230V - 50Hz	95	0,68	R404A	430	-

R290  R290 İstenildiği takdirde fiyatlara %3 ilave edilir. / For R290 Refrigerant gas, price increase is 3%.

TEKNİK DETAYLAR / TECHNICAL DETAILS

TR

- Dış ortam sıcaklığı +43°C %65 nem oranı
- Eşit sıcaklık dağılımı için yeni tasarım
- Sıfır ODP enjekte 42 kg/m³ çevre dostu poliüretan izolasyon
- Kolay okunur ekranlı dijital kontrol
- Ergonomik kapı ve kulpu sayesinde kolay açılma ve temizlik
- Patentli 'Icecool' soğutma sistemi ile mükemmel verim ve enerji sarfiyatı
- Sıcak gaz defrost sistemi
- Atık ısı geri kazanımlı kondanzasyon
- Tüm buzdolapların marine versiyonları mevcuttur.
- **1/1 Çekmece için; 1/1-200mm Gn kapasitesi.**
- **1/2 Çekmece için; 1/1-100mm Gn kapasitesi.**

EN

- Designed to operate in 43°C ambient %65 humidity
- New design for equal temperature distribution
- Zero ODP Injected 42 kg/m³ Polyurethane Insulation
- Digital controller with easy read screen
- Ergonomic door and handle designed for ease of opening and cleaning
- Icecool refrigeration system designed to be most technologically advanced and energy efficient yet
- Hot gas defrost system
- Waste heat recovery condensate vaporiser system
- All refrigerators can be produced in marine version
- **For 1/1 drawers; 1/1-200mm Gn capacity**
- **For 1/2 drawers; 1/1-100mm Gn capacity**

AIM 146L - 147L

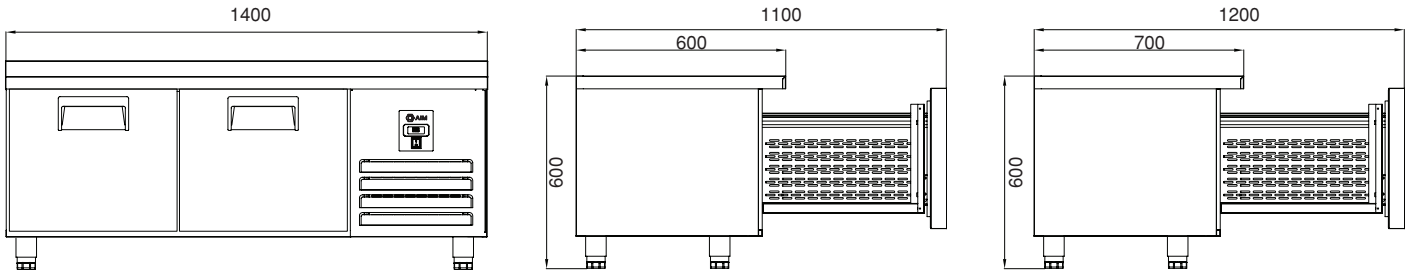

OPSİYONLAR / OPTIONS

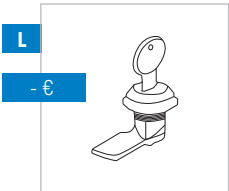

Dolap Kilidi / Cabinet Lock

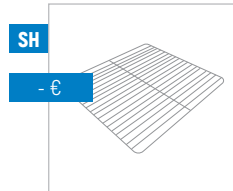

Raf ve Raf Kızağı / Shelf and Shelf Holder

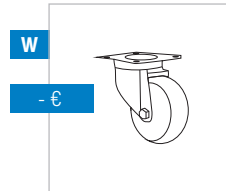

Tekerlekli - Wheels

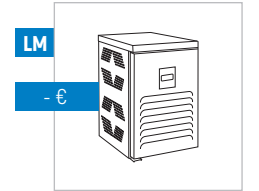

Sol Motor / Left Motor

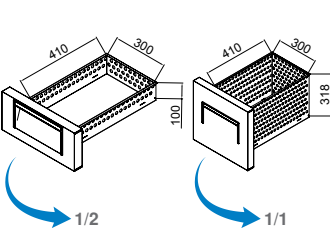

1/2

1/1

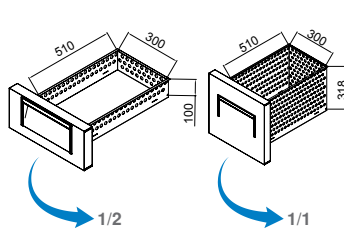

1/2

1/1

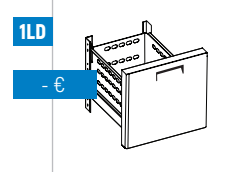

1/1 Çekmece - 1/1 Drawers

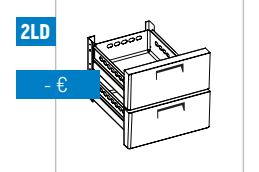

1/2 Çekmece - 1/2 Drawers

AIM

AIM 206L-207L

PİŞİRİCİ ALTI BUZDOLAPLARI - 3 KAPILI
LOW LEVEL REFRIGERATORS - W/3 KAPILI

80mm Üst Tabla İzolasyon Kalınlığı
 80mm Insulation Thickness on top



1/1 Çekmece
 1/1 Drawers



KOD / CODE	°C	[MM]	lt	⏻	kg	(kW)	❄️	PASLANMAZ TİPİ S.S. TYPE	€
AIM 206LR3	-2 / +8	2000x600x600	280	230V - 50Hz	120	0,34	R134A	304	-
AIM 206LR4	-2 / +8	2000x600x600	280	230V - 50Hz	120	0,34	R134A	430	-
AIM 206LF3	-10 / -22	2000x600x600	280	230V - 50Hz	120	0,75	R404A	304	-
AIM 206LF4	-10 / -22	2000x600x600	280	230V - 50Hz	120	0,75	R404A	430	-
AIM 207LR3	-2 / +8	2000x700x600	330	230V - 50Hz	128	0,34	R134A	304	-
AIM 207LR4	-2 / +8	2000x700x600	330	230V - 50Hz	128	0,34	R134A	430	-
AIM 207LF3	-10 / -22	2000x700x600	330	230V - 50Hz	128	0,75	R404A	304	-
AIM 207LF4	-10 / -22	2000x700x600	330	230V - 50Hz	128	0,75	R404A	430	-

 R290 İstenildiği takdirde fiyatlara %3 ilave edilir. / For R290 Refrigerant gas, price increase is 3%.

TEKNİK DETAYLAR / TECHNICAL DETAILS

TR

- Dış ortam sıcaklığı +43°C %65 nem oranı
- Eşit sıcaklık dağılımı için yeni tasarım
- Sıfır ODP enjekte 42 kg/m³ çevre dostu poliüretan izolasyon
- Kolay okunur ekranlı dijital kontrol
- Ergonomik kapı ve kulpu sayesinde kolay açılma ve temizlik
- Patentli 'Icecool' soğutma sistemi ile mükemmel verim ve enerji sarfiyatı
- Sıcak gaz defrost sistemi
- Atık ısı geri kazanımlı kondanzasyon
- Tüm buzdolapların marine versiyonları mevcuttur.
- **1/1 Çekmece için; 1/1-200mm Gn kapasitesi.**
- **1/2 Çekmece için; 1/1-100mm Gn kapasitesi.**

EN

- Designed to operate in 43°C ambient %65 humidity
- New design for equal temperature distribution
- Zero ODP Injected 42 kg/m³ Polyurethane Insulation
- Digital controller with easy read screen
- Ergonomic door and handle designed for ease of opening and cleaning
- Icecool refrigeration system designed to be most technologically advanced and energy efficient yet
- Hot gas defrost system
- Waste heat recovery condensate vaporiser system
- All refrigerators can be produced in marine version
- **For 1/1 drawers; 1/1-200mm Gn capacity**
- **For 1/2 drawers; 1/1-100mm Gn capacity**

AIM 206L-207L

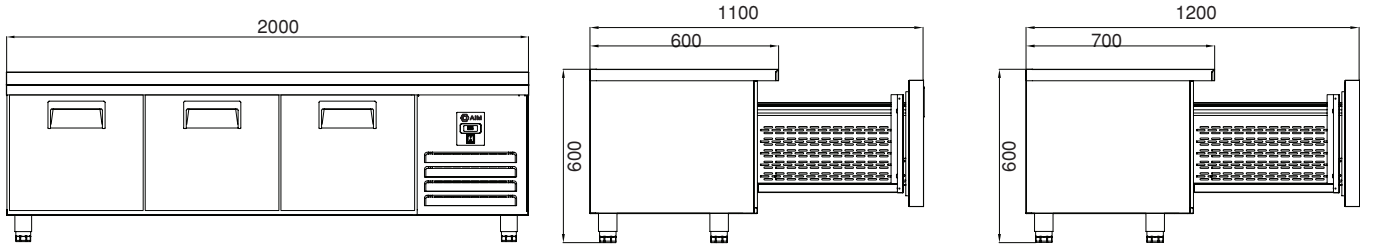

OPSİYONLAR / OPTIONS

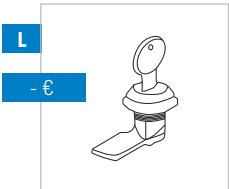

Dolap Kilidi / Cabinet Lock

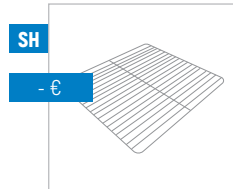

Raf ve Raf Kızağı / Shelf and Shelf Holder

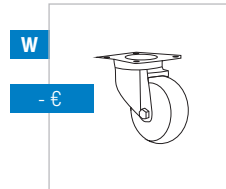

Tekerlekli - Wheels

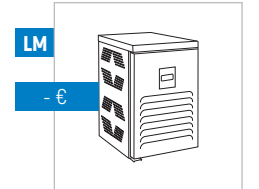

Sol Motor / Left Motor

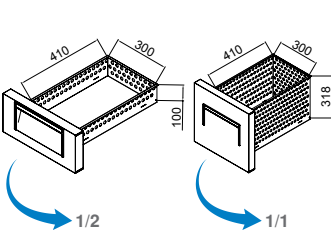

1/2

1/1

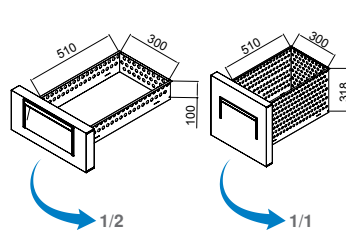

1/2

1/1

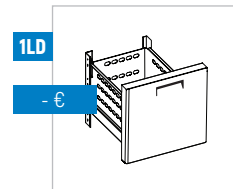

1/1 Çekmece - 1/1 Drawers

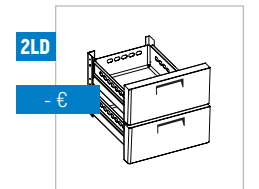

1/2 Çekmece - 1/2 Drawers

AIM

AIM 246L-247L

PİŞİRİCİ ALTI BUZDOLAPLARI - 4 KAPILI
LOW LEVEL REFRIGERATORS - W/4 DOORS

80mm Üst Tabla İzolasyon Kalınlığı
 80mm Insulation Thickness on top

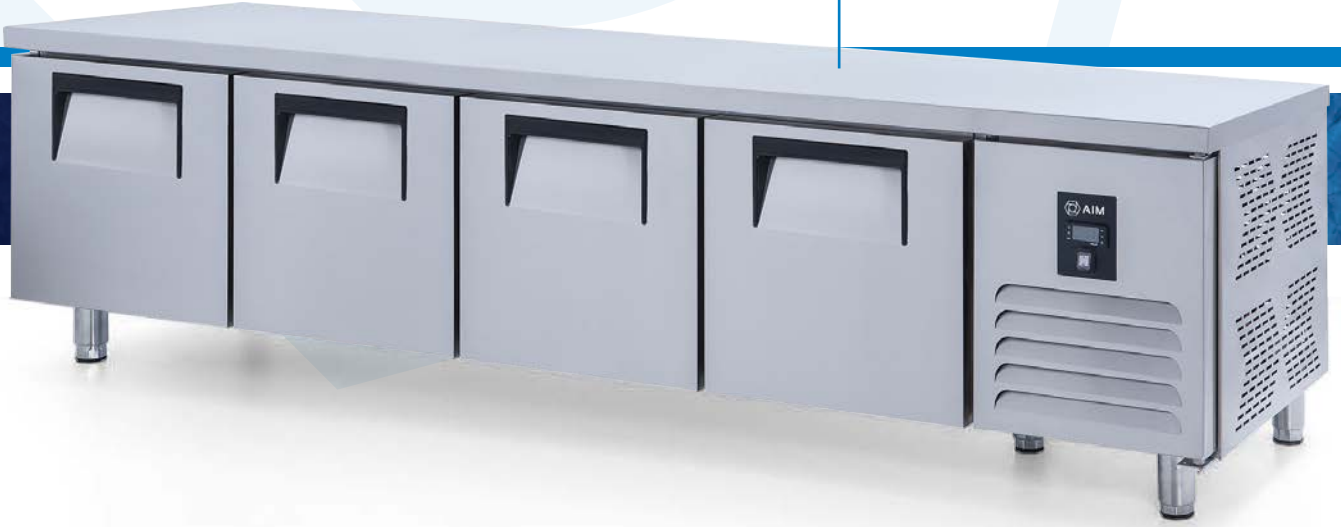

KOD / CODE	°C	(MM)	lit	⏻	kg	(WATT)	❄️	PASLANMAZ TİPİ S.S. TYPE	€
AIM 246LR3	-2 / +8	2400x600x600	370	230V - 50Hz	168	0,50	R134A	304	-
AIM 246LR4	-2 / +8	2400x600x600	370	230V - 50Hz	168	0,50	R134A	430	-
AIM 246LF3	-10 / -22	2400x600x600	370	230V - 50Hz	168	0,82	R404A	304	-
AIM 246LF4	-10 / -22	2400x600x600	370	230V - 50Hz	168	0,82	R404A	430	-
AIM 247LR3	-2 / +8	2400x700x600	450	230V - 50Hz	177	0,50	R134A	304	-
AIM 247LR4	-2 / +8	2400x700x600	450	230V - 50Hz	177	0,50	R134A	430	-
AIM 247LF3	-10 / -22	2400x700x600	450	230V - 50Hz	177	0,82	R404A	304	-
AIM 247LF4	-10 / -22	2400x700x600	450	230V - 50Hz	177	0,82	R404A	430	-

 R290 İstenildiği takdirde fiyatlara %3 ilave edilir. / For R290 Refrigerant gas, price increase is 3%.

TEKNİK DETAYLAR / TECHNICAL DETAILS

TR

- Dış ortam sıcaklığı +43°C %65 nem oranı
- Eşit sıcaklık dağılımı için yeni tasarım
- Sıfır ODP enjekte 42 kg/m³ çevre dostu poliüretan izolasyon
- Kolay okunur ekranlı dijital kontrol
- Ergonomik kapı ve kulpu sayesinde kolay açılma ve temizlik
- Patentli 'Icecool' soğutma sistemi ile mükemmel verim ve enerji sarfiyatı
- Sıcak gaz defrost sistemi
- Atık ısı geri kazanımlı kondanzasyon
- Tüm buzdolapların marine versiyonları mevcuttur.
- **1/1 Çekmece için; 1/1-200mm Gn kapasitesi.**
- **1/2 Çekmece için; 1/1-100mm Gn kapasitesi.**

EN

- Designed to operate in 43°C ambient %65 humidity
- New design for equal temperature distribution
- Zero ODP Injected 42 kg/m³ Polyurethane Insulation
- Digital controller with easy read screen
- Ergonomic door and handle designed for ease of opening and cleaning
- Icecool refrigeration system designed to be most technologically advanced and energy efficient yet
- Hot gas defrost system
- Waste heat recovery condensate vaporiser system
- All refrigerators can be produced in marine version
- **For 1/1 drawers; 1/1-200mm Gn capacity**
- **For 1/2 drawers; 1/1-100mm Gn capacity**

AIM 246L-247L

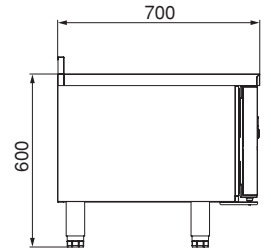
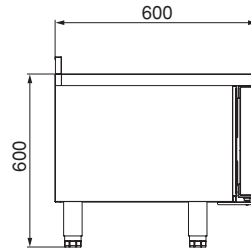
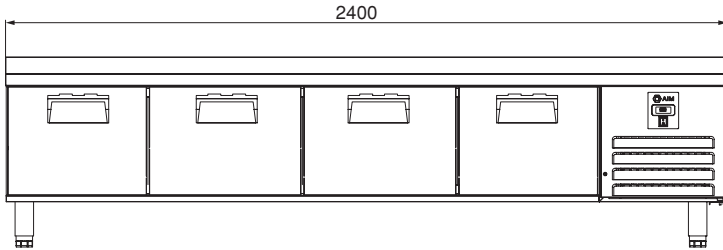

OPSİYONLAR / OPTIONS

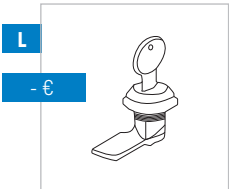

L
- €
Dolap Kilidi / Cabinet Lock

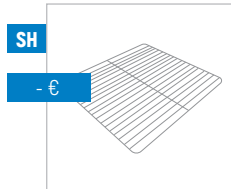

SH
- €
Raf ve Raf Kızağı /
Shelf and Shelf Holder

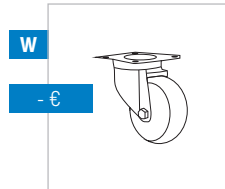

W
- €
Tekertecli - Wheels

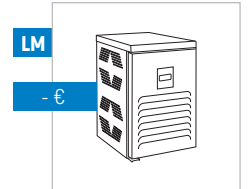

LM
- €
Sol Motor / Left Motor

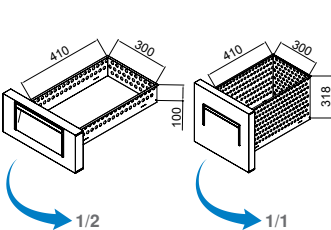

1/2

1/1

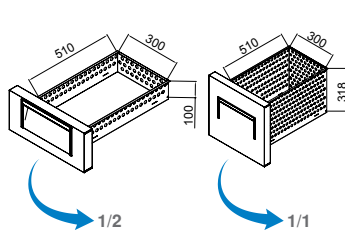

1/2

1/1

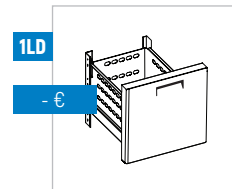

1LD
- €
1/1 Çekmece - 1/1 Drawers

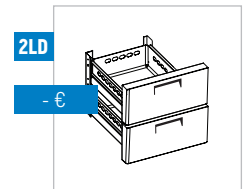

2LD
- €
1/2 Çekmece - 1/2 Drawers

AIM

AIM 126L-127L

PİŞİRİCİ ALTI BUZDOLAPLARI - 2 KAPILI - KISA
LOW LEVEL REFRIGERATORS - W/2 DOORS - SHORT

80mm Üst Tabla İzolasyon Kalınlığı
80mm Insulation Thickness on top



1/1 Çekmece
1/1 Drawers



KOD / CODE	°C	(MM)	İt	⏻	kg	(KW)	❄️	PASLANMAZ TİPİ S.S. TYPE	€
AIM 126LR3	-2 / +8	1200x600x600	190	230V - 50Hz	90	0,32	R134A	304	-
AIM 126LR4	-2 / +8	1200x600x600	190	230V - 50Hz	90	0,32	R134A	430	-
AIM 127LR3	-2 / +8	1200x700x600	220	230V - 50Hz	95	0,32	R134A	304	-
AIM 127LR4	-2 / +8	1200x700x600	220	230V - 50Hz	95	0,32	R134A	430	-

 R290 İstenildiği takdirde fiyatlara %3 ilave edilir. / For R290 Refrigerant gas, price increase is 3%.

TEKNİK DETAYLAR / TECHNICAL DETAILS

TR

- Dış ortam sıcaklığı +43°C %65 nem oranı
- Eşit sıcaklık dağılımı için yeni tasarım
- Sıfır ODP enjekte 42 kg/m³ çevre dostu poliüretan izolasyon
- Kolay okunur ekranlı dijital kontrol
- Ergonomik kapı ve kulpu sayesinde kolay açılma ve temizlik
- Patentli 'Icecool' soğutma sistemi ile mükemmel verim ve enerji sarfiyatı
- Sıcak gaz defrost sistemi
- Atık ısı geri kazanımlı kondanzasyon
- Tüm buzdolapların marine versiyonları mevcuttur.
- **1/1 Çekmece için; 1/1-200mm Gn kapasitesi.**
- **1/2 Çekmece için; 1/1-100mm Gn kapasitesi.**

EN

- Designed to operate in 43°C ambient %65 humidity
- New design for equal temperature distribution
- Zero ODP Injected 42 kg/m³ Polyurethane Insulation
- Digital controller with easy read screen
- Ergonomic door and handle designed for ease of opening and cleaning
- Icecool refrigeration system designed to be most technologically advanced and energy efficient yet
- Hot gas defrost system
- Waste heat recovery condensate vaporiser system
- All refrigerators can be produced in marine version
- **For 1/1 drawers; 1/1-200mm Gn capacity**
- **For 1/2 drawers; 1/1-100mm Gn capacity**

AIM 126L-127L

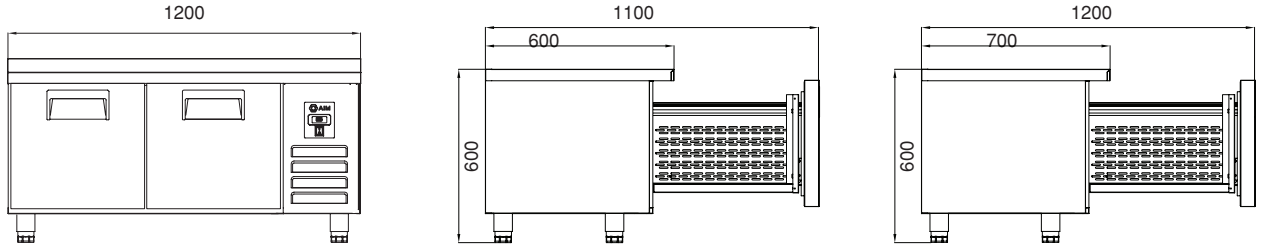

OPSİYONLAR / OPTIONS

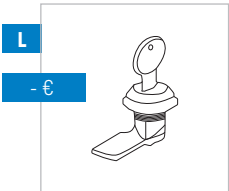

Dolap Kilidi / Cabinet Lock

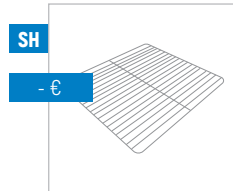

Raf ve Raf Kızağı / Shelf and Shelf Holder

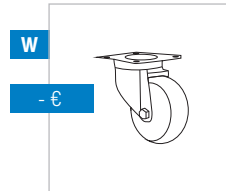

Tekerekli - Wheels

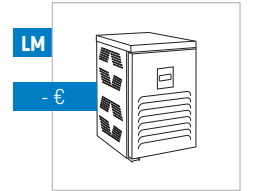

Sol Motor / Left Motor

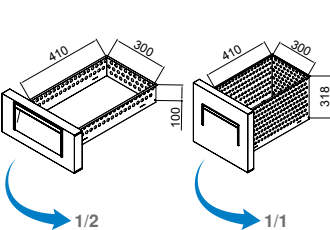

1/2

1/1

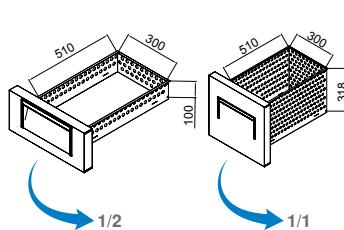

1/2

1/1

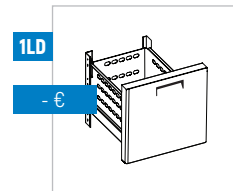

1/1 Çekmece - 1/1 Drawers

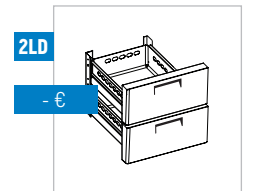

1/2 Çekmece - 1/2 Drawers

AIM

AIM 166L-167L

PİŞİRİCİ ALTI BUZDOLAPLARI - 3 KAPILI - KISA
LOW LEVEL REFRIGERATORS - W/3 KAPILI - SHORT

80mm Üst Tabla İzolasyon Kalınlığı
80mm Insulation Thickness on top



1/1 Çekmece
1/1 Drawers



KOD / CODE	°C	(MM)	lt	⏻	kg	(KW)	❄️	PASLANMAZ TİPİ S.S. TYPE	€
AIM 166LR3	-2 / +8	1600x600x600	280	230V - 50Hz	118	0,40	R134A	304	-
AIM 166LR4	-2 / +8	1600x600x600	280	230V - 50Hz	118	0,40	R134A	430	-
AIM 167LR3	-2 / +8	1600x700x600	330	230V - 50Hz	125	0,40	R134A	304	-
AIM 167LR4	-2 / +8	1600x700x600	330	230V - 50Hz	125	0,40	R134A	430	-

 R290 İstenildiği takdirde fiyatlara %3 ilave edilir. / For R290 Refrigerant gas, price increase is 3%.

TEKNİK DETAYLAR / TECHNICAL DETAILS

TR

- Dış ortam sıcaklığı +43°C %65 nem oranı
- Eşit sıcaklık dağılımı için yeni tasarım
- Sıfır ODP enjekte 42 kg/m³ çevre dostu poliüretan izolasyon
- Kolay okunur ekranlı dijital kontrol
- Ergonomik kapı ve kulpu sayesinde kolay açılma ve temizlik
- Patentli 'Icecool' soğutma sistemi ile mükemmel verim ve enerji sarfiyatı
- Sıcak gaz defrost sistemi
- Atık ısı geri kazanımlı kondanzasyon
- Tüm buzdolapların marine versiyonları mevcuttur.
- **1/1 Çekmece için; 1/1-200mm Gn kapasitesi.**
- **1/2 Çekmece için; 1/1-100mm Gn kapasitesi.**

EN

- Designed to operate in 43°C ambient %65 humidity
- New design for equal temperature distribution
- Zero ODP Injected 42 kg/m³ Polyurethane Insulation
- Digital controller with easy read screen
- Ergonomic door and handle designed for ease of opening and cleaning
- Icecool refrigeration system designed to be most technologically advanced and energy efficient yet
- Hot gas defrost system
- Waste heat recovery condensate vaporiser system
- All refrigerators can be produced in marine version
- **For 1/1 drawers; 1/1-200mm Gn capacity**
- **For 1/2 drawers; 1/1-100mm Gn capacity**

AIM 166L-167L

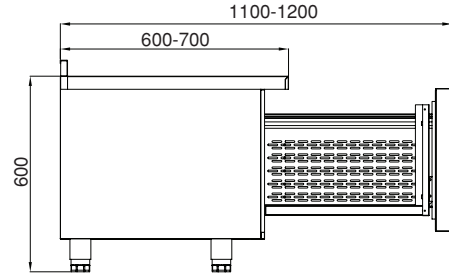
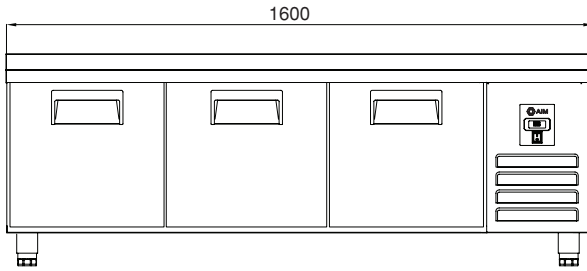

OPSİYONLAR / OPTIONS

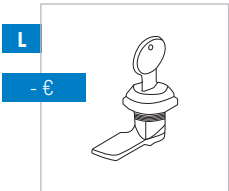

L
- €
Dolap Kilidi / Cabinet Lock

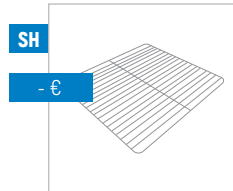

SH
- €
Raf ve Raf Kızağı /
Shelf and Shelf Holder

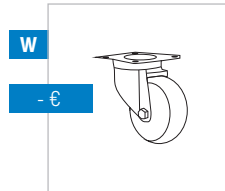

W
- €
Tekertecli - Wheels

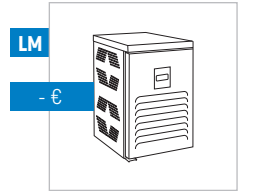

LM
- €
Sol Motor / Left Motor

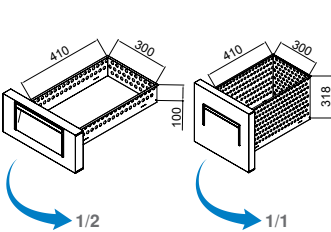

1/2

1/1

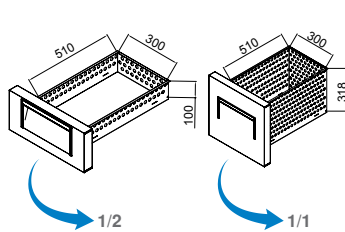

1/2

1/1

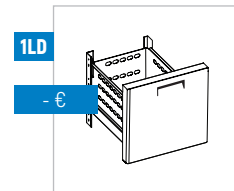

1LD
- €
1/1 Çekmece - 1/1 Drawers

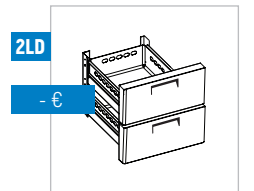

2LD
- €
1/2 Çekmece - 1/2 Drawers

HAZIRLIK BUZDOLAPLARI



AIM

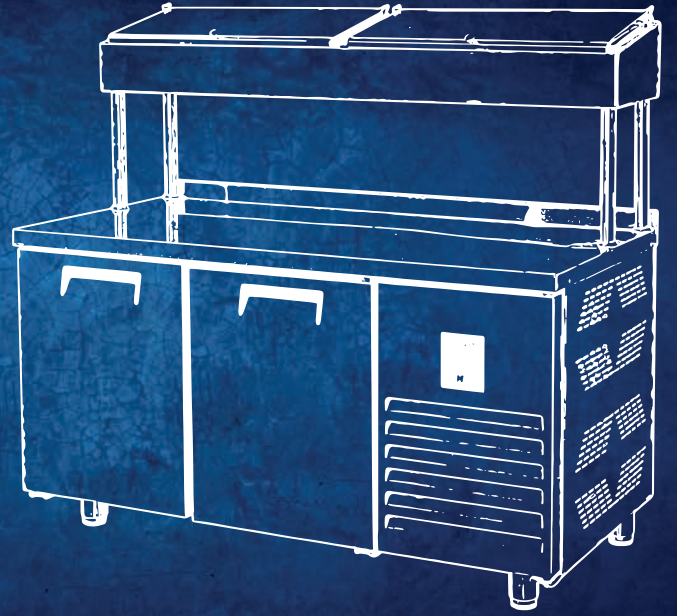

MAKE-UP SERIES

YENİ KONDENSER SİSTEMİ NEW CONDENSER SYSTEM



CLASSIC



AIMCLEAR

Temizlik gerektirmeyen kondenser
Stayclear Condenser

ENERJİ TASARRUFU SAVING ENERGY



Düşük enerji tüketimi sağlayan çevre dostu HFC içermeyen poliüretan izolasyon
Eco friendly, HFC - free polyurethane insulation providing low energy consumption

SICAK GAZ DEFOST İLE KARLANMAYAN EVAPARATÖR EVAPARATOR DOES NOT SNOW THROUGH HOT GAS DEFROST

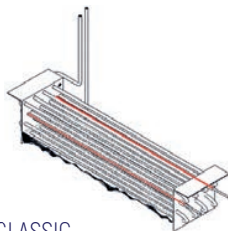

CLASSIC

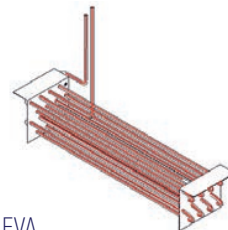

AIMEVA

AIM

AIM 156M-157M

MAKE UP BUZDOLAPLARI - 2 KAPILI - YÜKSEK
MAKE UP REFRIGERATORS - W/2 DOORS - HIGH



1/2 Çekmece
1/2 Drawers

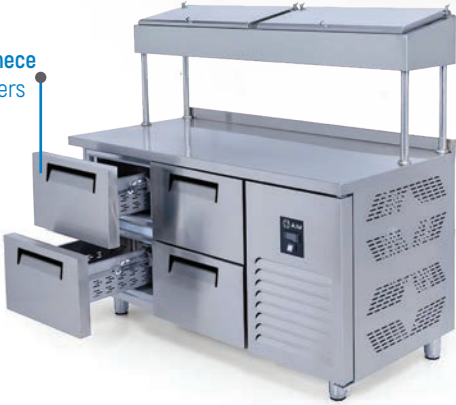

KOD / CODE	°C	📏 (MM)	It	🔌	kg	⚡ (KW)	❄️	PASLANMAZ TİPİ S.S. TYPE	€
AIM 156M3	-2 / +8	1500x600x850/140	275	230V - 50Hz	116	0,32	R134A	304	-
AIM 156M4	-2 / +8	1500x600x850/140	275	230V - 50Hz	116	0,32	R134A	430	-
AIM 157M3	-2 / +8	1500x700x850/140	330	230V - 50Hz	123	0,32	R134A	304	-
AIM 157M4	-2 / +8	1500x700x850/140	330	230V - 50Hz	123	0,32	R134A	430	-

 R290 İstenildiği takdirde fiyatlara %3 ilave edilir. / For R290 Refrigerant gas, price increase is 3%.

TEKNİK DETAYLAR / TECHNICAL DETAILS

TR

- Dış ortam sıcaklığı +43°C %65 nem oranı
- Eşit sıcaklık dağılımı için yeni tasarım
- Sıfır ODP enjekte 42 kg/m³ çevre dostu poliüretan izolasyon
- Kolay okunur ekranlı dijital kontrol
- Ergonomik kapı ve kulpu sayesinde kolay açılma ve temizlik
- Patentli 'Icecool' soğutma sistemi ile mükemmel verim ve enerji sarfiyatı
- Sıcak gaz defrost sistemi
- Atık ısı geri kazanımlı kondanzasyon
- Tüm buzdolapların marine versiyonları mevcuttur.
- **8 Adet 1/4-100 Gn kapasitesi.**

EN

- Designed to operate in 43°C ambient %65 humidity
- New design for equal temperature distribution
- Zero ODP Injected 42 kg/m³ Polyurethane Insulation
- Digital controller with easy read screen
- Ergonomic door and handle designed for ease of opening and cleaning
- Icecool refrigeration system designed to be most technologically advanced and energy efficient yet
- Hot gas defrost system
- Waste heat recovery condensate vaporiser system
- All refrigerators can be produced in marine version
- **8 No's 1/4-100mm Gn capacity**

AIM 156M-157M

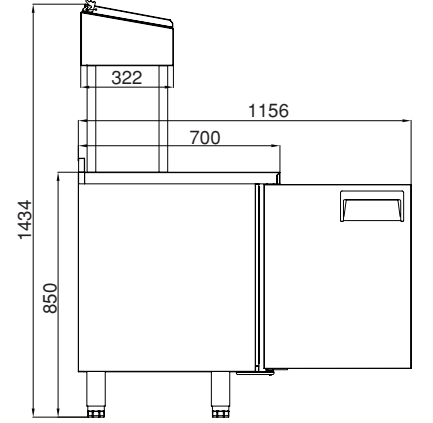
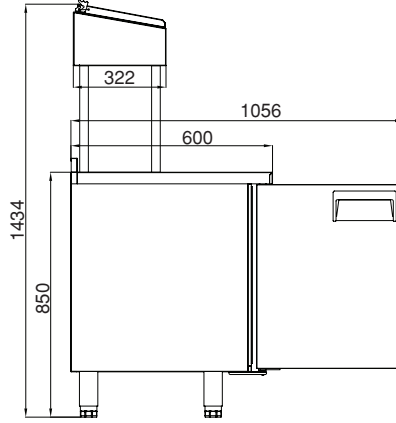
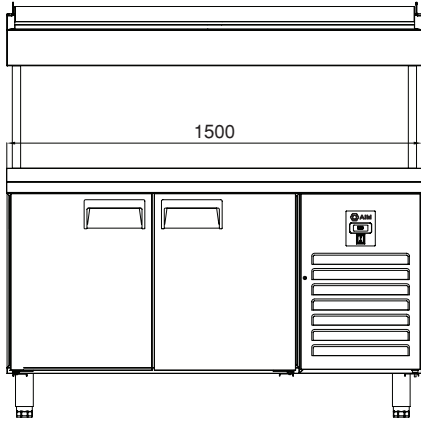

OPSİYONLAR / OPTIONS

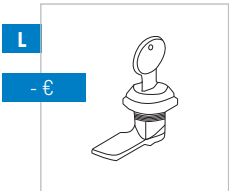

L
- €
Dolap Kilidi / Cabinet Lock



W
- €
Tekerlekli - Wheels

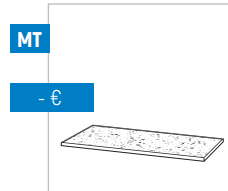

MT
- €
Mermer Tabla / Marble Top

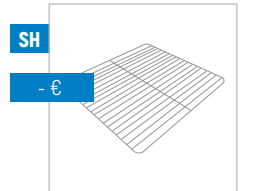

SH
- €
Raf ve Raf Kızağı / Shelf and Shelf Holder



Gastronom küvetler fiyata dahil değildir.
Gn containers are not included in the price.

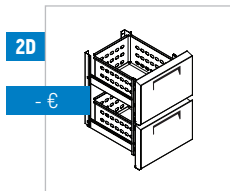

2D
- €
1/2 Çekmece - 1/2 Drawers

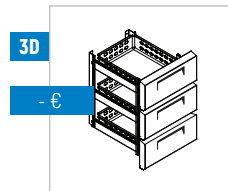

3D
- €
1/3 Çekmece - 1/3 Drawers

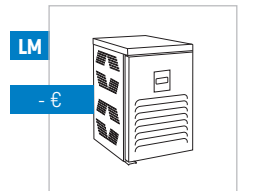

LM
- €
Sol Motor / Left Motor

AIM

AIM 206M-207M

MAKE UP BUZDOLAPLARI - 3 KAPILI - YÜKSEK
MAKE UP REFRIGERATORS - W/3 DOORS - HIGH



1/2 Çekmece
1/2 Drawers



KOD / CODE	°C	(MM)	It	Power	kg	(KW)	R	PASLANMAZ TİPİ S.S. TYPE	€
AIM 206M3	-2 / +8	2000x600x850/1430	440	230V - 50Hz	195	0,40	R134A	304	-
AIM 206M4	-2 / +8	2000x600x850/1430	440	230V - 50Hz	195	0,40	R134A	430	-
AIM 207M3	-2 / +8	2000x700x850/1430	515	230V - 50Hz	205	0,40	R134A	304	-
AIM 207M4	-2 / +8	2000x700x850/1430	515	230V - 50Hz	205	0,40	R134A	430	-

 R290 İstenildiği takdirde fiyatlara %3 ilave edilir. / For R290 Refrigerant gas, price increase is 3%.

TEKNİK DETAYLAR / TECHNICAL DETAILS

TR

- Dış ortam sıcaklığı +43°C %65 nem oranı
- Eşit sıcaklık dağılımı için yeni tasarım
- Sıfır ODP enjekte 42 kg/m³ çevre dostu poliüretan izolasyon
- Kolay okunur ekranlı dijital kontrol
- Ergonomik kapı ve kulpu sayesinde kolay açılma ve temizlik
- Patentli 'Icecool' soğutma sistemi ile mükemmel verim ve enerji sarfiyatı
- Sıcak gaz defrost sistemi
- Atık ısı geri kazanımlı kondanzasyon
- Tüm buzdolapların marine versiyonları mevcuttur.
- **12 Adet 1/4-100 Gn kapasitesi.**

EN

- Designed to operate in 43°C ambient %65 humidity
- New design for equal temperature distribution
- Zero ODP Injected 42 kg/m³ Polyurethane Insulation
- Digital controller with easy read screen
- Ergonomic door and handle designed for ease of opening and cleaning
- Icecool refrigeration system designed to be most technologically advanced and energy efficient yet
- Hot gas defrost system
- Waste heat recovery condensate vaporiser system
- All refrigerators can be produced in marine version
- **12 No's 1/4-100mm Gn capacity**

AIM 206M-207M

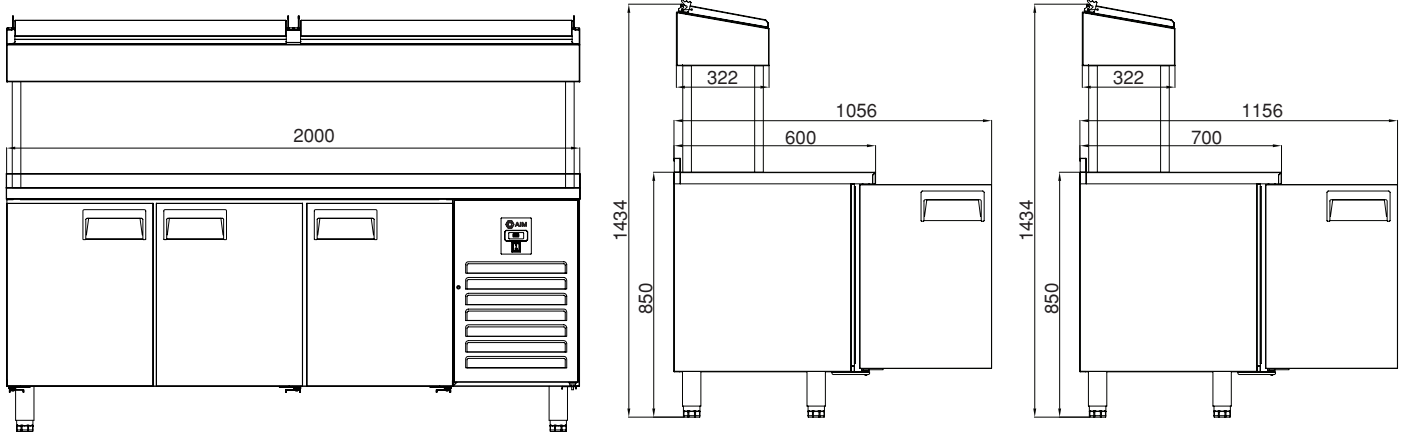

OPSİYONLAR / OPTIONS

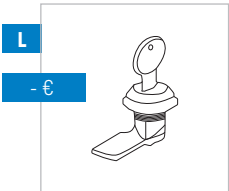

L
- €
Dolap Kilidi / Cabinet Lock



W
- €
Tekerlekli - Wheels

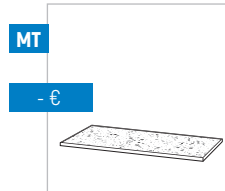

MT
- €
Mermer Tabla / Marble Top

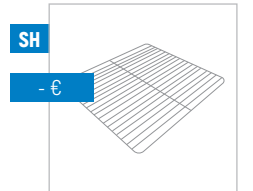

SH
- €
Raf ve Raf Kızağı / Shelf and Shelf Holder



Gastronom küvetler fiyata dahil değildir.
Gn containers are not included in the price.

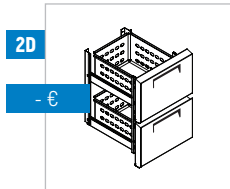

2D
- €
1/2 Çekmece -
1/2 Drawers

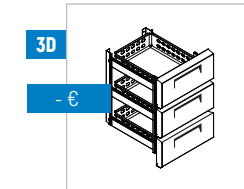

3D
- €
1/3 Çekmece -
1/3 Drawers

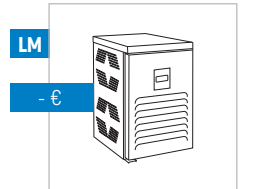

LM
- €
Sol Motor / Left Motor

AIM

AIM 256M-257M

MAKE UP BUZDOLAPLARI - 4 KAPILI - YÜKSEK
MAKE UP REFRIGERATORS - W/4 DOORS - HIGH



1/2 Çekmece
1/2 Drawers



KOD / CODE	°C	(MM)	It	⏻	kg	(KW)	❄️	PASLANMAZ TİPİ S.S. TYPE	€
AIM 256M3	-2 / +8	2500x600x850/1430	560	230V - 50Hz	198	0,50	R134A	304	-
AIM 256M4	-2 / +8	2500x600x850/1430	560	230V - 50Hz	198	0,50	R134A	430	-
AIM 257M3	-2 / +8	2500x700x850/1430	650	230V - 50Hz	209	0,50	R134A	304	-
AIM 257M4	-2 / +8	2500x700x850/1430	650	230V - 50Hz	209	0,50	R134A	430	-

 R290 İstenildiği takdirde fiyatlara %3 ilave edilir. / For R290 Refrigerant gas, price increase is 3%.

TEKNİK DETAYLAR / TECHNICAL DETAILS

TR

- Dış ortam sıcaklığı +43°C %65 nem oranı
- Eşit sıcaklık dağılımı için yeni tasarım
- Sıfır ODP enjekte 42 kg/m³ çevre dostu poliüretan izolasyon
- Kolay okunur ekranlı dijital kontrol
- Ergonomik kapı ve kulpu sayesinde kolay açılma ve temizlik
- Patentli 'Icecool' soğutma sistemi ile mükemmel verim ve enerji sarfıyatı
- Sıcak gaz defrost sistemi
- Atık ısı geri kazanımlı kondanzasyon
- Tüm buzdolapların marine versiyonları mevcuttur.
- **15 Adet 1/4-100 Gn kapasitesi.**

EN

- Designed to operate in 43°C ambient %65 humidity
- New design for equal temperature distribution
- Zero ODP Injected 42 kg/m³ Polyurethane Insulation
- Digital controller with easy read screen
- Ergonomic door and handle designed for ease of opening and cleaning
- Icecool refrigeration system designed to be most technologically advanced and energy efficient yet
- Hot gas defrost system
- Waste heat recovery condensate vaporiser system
- All refrigerators can be produced in marine version
- **15 No's 1/4-100mm Gn capacity**

AIM 256M-257M

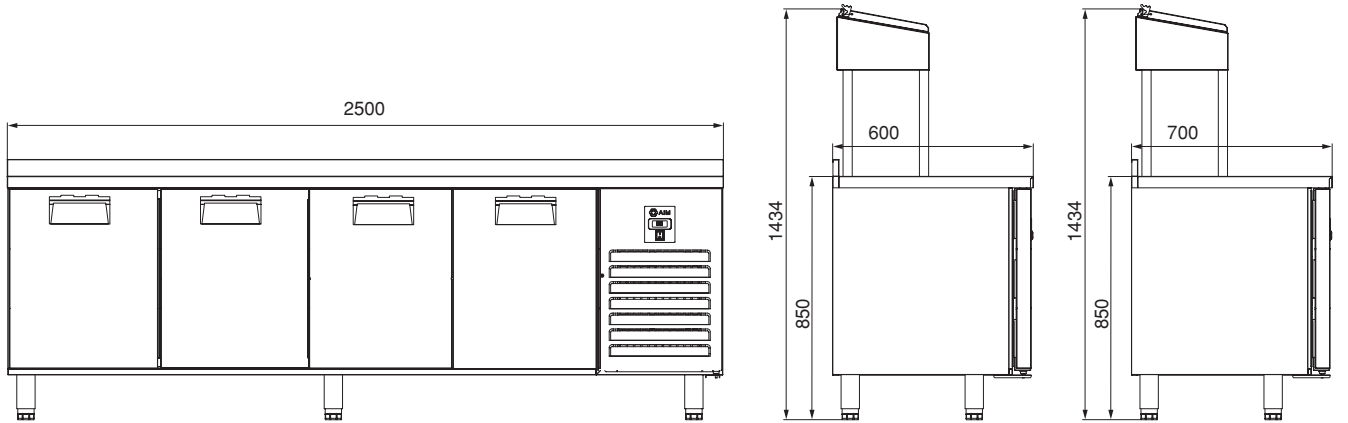

OPSİYONLAR / OPTIONS

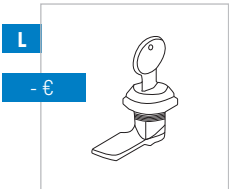

L
- €
Dolap Kilidi / Cabinet Lock



W
- €
Tekerlekli - Wheels

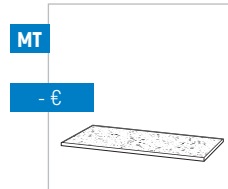

MT
- €
Mermer Tabla / Marble Top

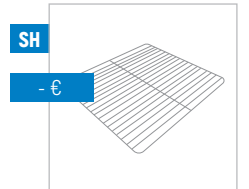

SH
- €
Raf ve Raf Kızağı / Shelf and Shelf Holder



Gastronom küvetler fiyata dahil değildir.
Gn containers are not included in the price.

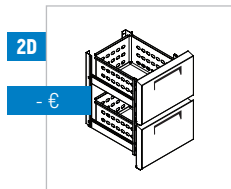

2D
- €
1/2 Çekmece -
1/2 Drawers

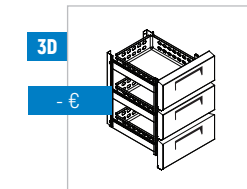

3D
- €
1/3 Çekmece -
1/3 Drawers

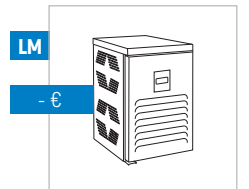

LM
- €
Sol Motor / Left Motor

AIM

AIM 157MS

MAKE UP BUZDOLAPLARI - 2 KAPILI - KISA
MAKE UP REFRIGERATORS - W/2 DOORS - SHORT



KOD / CODE	°C	(MM)	lit	⏻	kg	[KW]	⚡	PASLANMAZ TİPİ S.S. TYPE	€
AIM 157MS3	-2 / +8	1500x700x850/970	330	230V - 50Hz	123	0,32	R134A	304	-
AIM 157MS4	-2 / +8	1500x700x850/970	330	230V - 50Hz	123	0,32	R134A	430	-

 R290 İstenildiği takdirde fiyatlara %3 ilave edilir. / For R290 Refrigerant gas, price increase is 3%.

TEKNİK DETAYLAR / TECHNICAL DETAILS

TR

- Dış ortam sıcaklığı +43°C %65 nem oranı
- Eşit sıcaklık dağılımı için yeni tasarım
- Sıfır ODP enjekte 42 kg/m³ çevre dostu poliüretan izolasyon
- Kolay okunur ekranlı dijital kontrol
- Ergonomik kapı ve kulpu sayesinde kolay açılma ve temizlik
- Patentli 'Icecool' soğutma sistemi ile mükemmel verim ve enerji sarfiyatı
- Sıcak gaz defrost sistemi
- Atık ısı geri kazanımlı kondanzasyon
- Tüm buzdolapların marine versiyonları mevcuttur.
- **8 Adet 1/4-100 Gn kapasitesi.**

EN

- Designed to operate in 43°C ambient %65 humidity
- New design for equal temperature distribution
- Zero ODP Injected 42 kg/m³ Polyurethane Insulation
- Digital controller with easy read screen
- Ergonomic door and handle designed for ease of opening and cleaning
- Icecool refrigeration system designed to be most technologically advanced and energy efficient yet
- Hot gas defrost system
- Waste heat recovery condensate vaporiser system
- All refrigerators can be produced in marine version
- **8 No's 1/4-100mm Gn capacity**

AIM 157MS

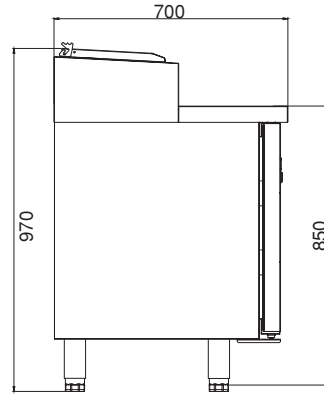
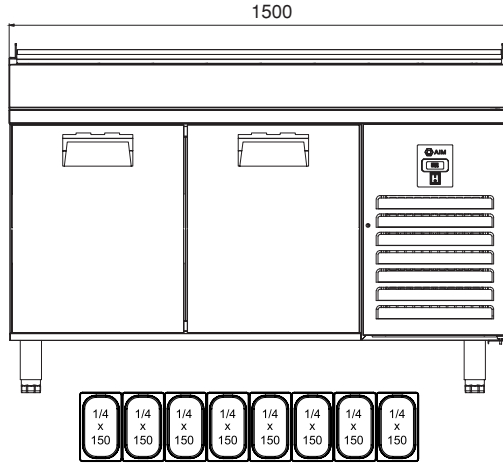

OPSİYONLAR / OPTIONS

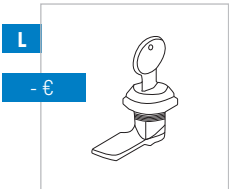

L
- €
Dolap Kilidi / Cabinet Lock



W
- €
Tekerlekli - Wheels

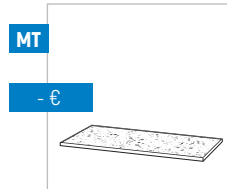

MT
- €
Mermer Tabla / Marble Top

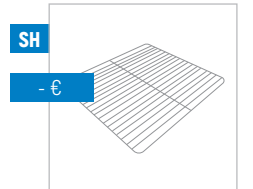

SH
- €
Raf ve Raf Kızağı / Shelf and Shelf Holder



Gastronom küvetler fiyata dahil değildir.
Gn containers are not included in the price.

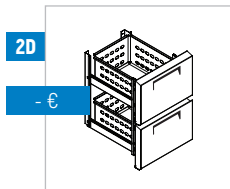

2D
- €
1/2 Çekmece -
1/2 Drawers

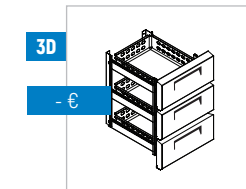

3D
- €
1/3 Çekmece -
1/3 Drawers

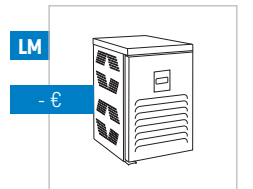

LM
- €
Sol Motor / Left Motor

AIM

AIM 207MS

MAKE UP BUZDOLAPLARI - 3 KAPILI - KISA
MAKE UP REFRIGERATORS - W/3 DOORS - SHORT



KOD / CODE	°C	(MM)	lit	Power	kg	(KW)	R134A	PASLANMAZ TİPİ S.S. TYPE	€
AIM 207MS3	-2 / +8	2000x700x970	515	230V - 50Hz	205	0,36	R134A	304	-
AIM 207MS4	-2 / +8	2000x700x970	515	230V - 50Hz	205	0,36	R134A	430	-

 R290 İstenildiği takdirde fiyatlara %3 ilave edilir. / For R290 Refrigerant gas, price increase is 3%.

TEKNİK DETAYLAR / TECHNICAL DETAILS

TR

- Dış ortam sıcaklığı +43°C %65 nem oranı
- Eşit sıcaklık dağılımı için yeni tasarım
- Sıfır ODP enjekte 42 kg/m³ çevre dostu poliüretan izolasyon
- Kolay okunur ekranlı dijital kontrol
- Ergonomik kapı ve kulpu sayesinde kolay açılma ve temizlik
- Patentli 'Icecool' soğutma sistemi ile mükemmel verim ve enerji sarfiyatı
- Sıcak gaz defrost sistemi
- Atık ısı geri kazanımlı kondanzasyon
- Tüm buzdolapların marine versiyonları mevcuttur.
- **11 Adet 1/4-100 Gn kapasitesi.**

EN

- Designed to operate in 43°C ambient %65 humidity
- New design for equal temperature distribution
- Zero ODP Injected 42 kg/m³ Polyurethane Insulation
- Digital controller with easy read screen
- Ergonomic door and handle designed for ease of opening and cleaning
- Icecool refrigeration system designed to be most technologically advanced and energy efficient yet
- Hot gas defrost system
- Waste heat recovery condensate vaporiser system
- All refrigerators can be produced in marine version
- **11 No's 1/4-100mm Gn capacity**

AIM 207MS

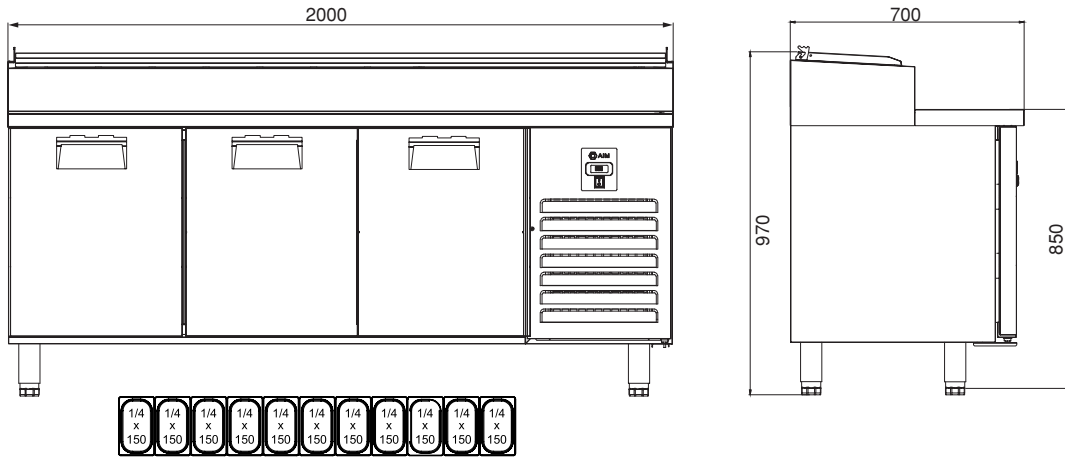

OPSİYONLAR / OPTIONS

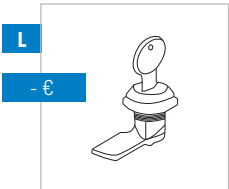

L
- €
Dolap Kilidi / Cabinet Lock



W
- €
Tekerlekli - Wheels

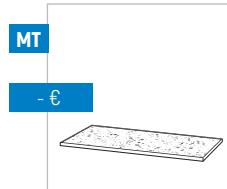

MT
- €
Mermer Tabla / Marble Top

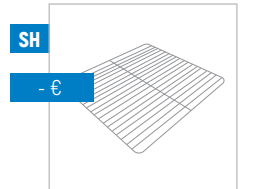

SH
- €
Raf ve Raf Kızağı / Shelf and Shelf Holder



Gastronom küvetler fiyata dahil değildir.
Gn containers are not included in the price.

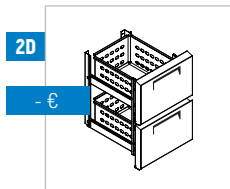

2D
- €
1/2 Çekmece -
1/2 Drawers

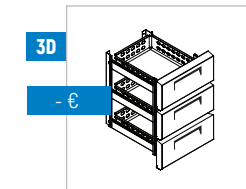

3D
- €
1/3 Çekmece -
1/3 Drawers

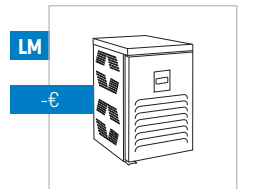

LM
- €
Sol Motor / Left Motor

AIM

AIM 257MS

MAKE UP BUZDOLAPLARI - 4 KAPILI - KISA
MAKE UP REFRIGERATORS - W/4 DOORS - SHORT



KOD / CODE	°C	(MM)	lt	⏻	kg	(KW)	❄️	PASLANMAZ TİPİ S.S. TYPE	€
AIM 257MS3	-2 / +8	2500x700x970	650	230V - 50Hz	209	0,50	R134A	304	-
AIM 257MS4	-2 / +8	2500x700x970	650	230V - 50Hz	209	0,50	R134A	430	-

 R290 İstenildiği takdirde fiyatlara %3 ilave edilir. / For R290 Refrigerant gas, price increase is 3%.

TEKNİK DETAYLAR / TECHNICAL DETAILS

TR

- Dış ortam sıcaklığı +43°C %65 nem oranı
- Eşit sıcaklık dağılımı için yeni tasarım
- Sıfır ODP enjekte 42 kg/m³ çevre dostu poliüretan izolasyon
- Kolay okunur ekranlı dijital kontrol
- Ergonomik kapı ve kulpu sayesinde kolay açılma ve temizlik
- Patentli 'Icecool' soğutma sistemi ile mükemmel verim ve enerji sarfiyatı
- Sıcak gaz defrost sistemi
- Atık ısı geri kazanımlı kondanzasyon
- Tüm buzdolapların marine versiyonları mevcuttur.
- **14 Adet 1/4-100 Gn kapasitesi.**

EN

- Designed to operate in 43°C ambient %65 humidity
- New design for equal temperature distribution
- Zero ODP Injected 42 kg/m³ Polyurethane Insulation
- Digital controller with easy read screen
- Ergonomic door and handle designed for ease of opening and cleaning
- Icecool refrigeration system designed to be most technologically advanced and energy efficient yet
- Hot gas defrost system
- Waste heat recovery condensate vaporiser system
- All refrigerators can be produced in marine version
- **14 No's 1/4-100mm Gn capacity**

AIM 257MS

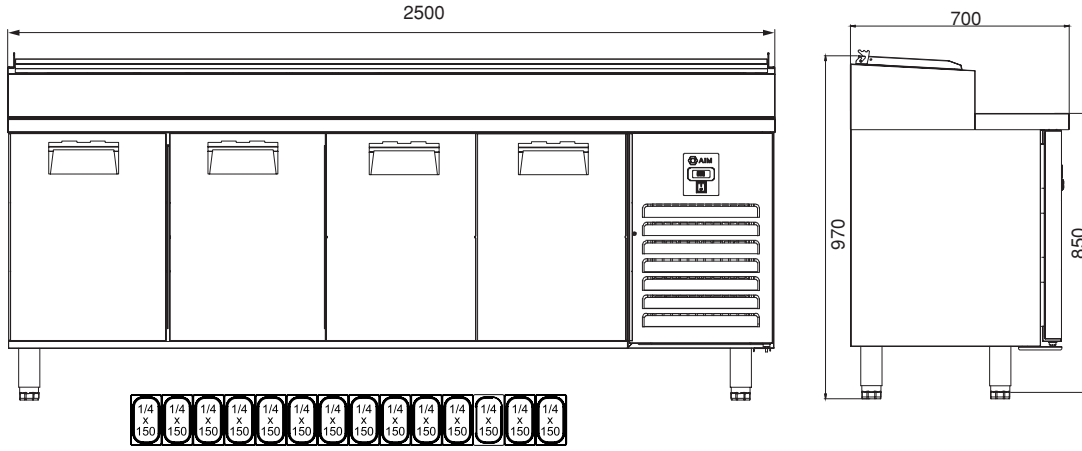

OPSİYONLAR / OPTIONS

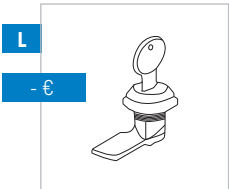

L
- €
Dolap Kilidi / Cabinet Lock



W
- €
Tekerlekli - Wheels

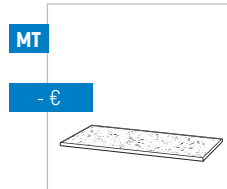

MT
- €
Mermer Tabla / Marble Top

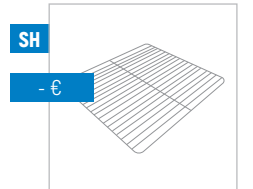

SH
- €
Raf ve Raf Kızağı / Shelf and Shelf Holder



Gastronom küvetler fiyata dahil değildir.
Gn containers are not included in the price.

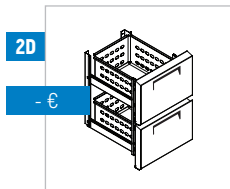

2D
- €
1/2 Çekmece -
1/2 Drawers

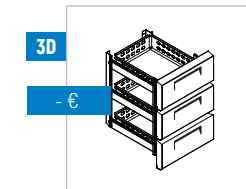

3D
- €
1/3 Çekmece -
1/3 Drawers

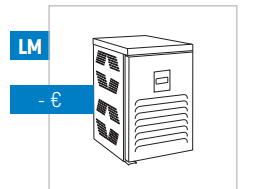

LM
- €
Sol Motor / Left Motor

AIM

AIM 157SB

MAKE UP BUZDOLAPLARI - MERMERLİ
MAKE UP REFRIGERATORS - W/MARBLE



KOD / CODE	°C	(MM)	it	⏻	kg	(KW)	❄️	GN 1/4-150	PASLANMAZ TİPİ S.S. TYPE	€
AIM 157M3-SB	-2 / +8	1500x700x850/140	330	230V - 50Hz	146	0,321	R134A	9	304	-
AIM 157M4-SB	-2 / +8	1500x700x850/140	330	230V - 50Hz	146	0,321	R134A	9	430	-
AIM 207M3-SB	-2 / +8	2000x700x850/140	515	230V - 50Hz	247	0,336	R134A	12	304	-
AIM 207M4-SB	-2 / +8	2000x700x850/140	515	230V - 50Hz	247	0,336	R134A	12	430	-
AIM 257M3-SB	-2 / +8	2000x700x850/140	650	230V - 50Hz	262	0,501	R134A	15	304	-
AIM 257M4-SB	-2 / +8	2000x700x850/140	650	230V - 50Hz	262	0,501	R134A	15	430	-

 R290 İstenildiği takdirde fiyatlara %3 ilave edilir. / For R290 Refrigerant gas, price increase is 3%.

TEKNİK DETAYLAR / TECHNICAL DETAILS

TR

- Dış ortam sıcaklığı +43°C %65 nem oranı
- Eşit sıcaklık dağılımı için yeni tasarım
- Sıfır ODP enjekte 42 kg/m³ çevre dostu poliüretan izolasyon
- Kolay okunur ekranlı dijital kontrol
- Ergonomik kapı ve kulpu sayesinde kolay açılma ve temizlik
- Patentli 'Icecool' soğutma sistemi ile mükemmel verim ve enerji sarfiyatı
- Sıcak gaz defrost sistemi
- Atık ısı geri kazanımlı kondanzasyon
- Tüm buzdolapların marine versiyonları mevcuttur.

EN

- Designed to operate in 43°C ambient %65 humidity
- New design for equal temperature distribution
- Zero ODP Injected 42 kg/m³ Polyurethane Insulation
- Digital controller with easy read screen
- Ergonomic door and handle designed for ease of opening and cleaning
- Icecool refrigeration system designed to be most technologically advanced and energy efficient yet
- Hot gas defrost system
- Waste heat recovery condensate vaporiser system
- All refrigerators can be produced in marine version

AIM 157SB

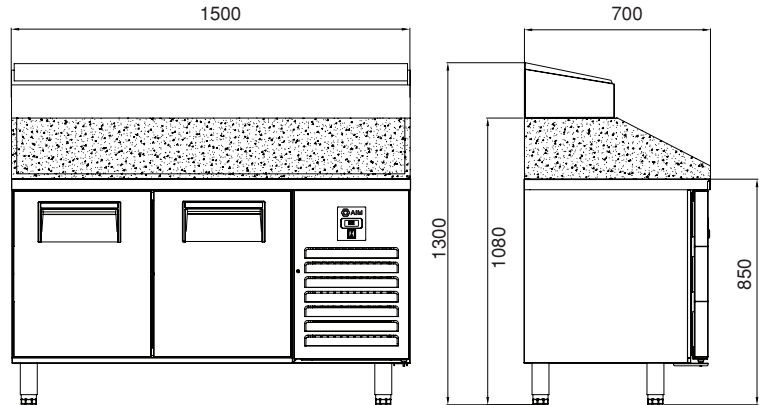
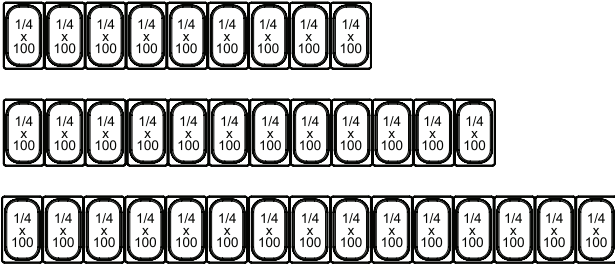

OPSİYONLAR / OPTIONS

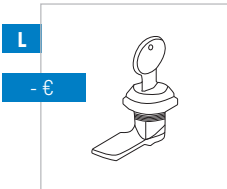

Dolap Kilidi /
Cabinet Lock

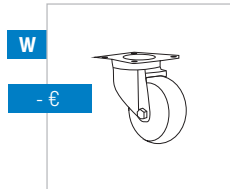

Tekerlekli - Wheels

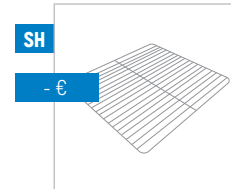

Raf ve Raf Kızağı /
Shelf and Shelf Holder

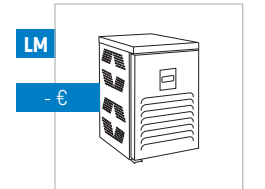

Sol Motor / Left Motor



Gastronom küvetler fiyata dahil değildir.
Gn containers are not included in the price.

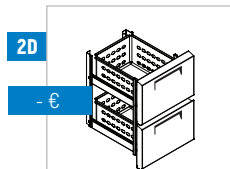

1/2 Çekmece - 1/2 Drawers

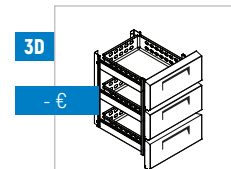

1/3 Çekmece - 1/3 Drawers

AIM

AIM 158 40X60

MAKE UP BUZDOLAPLARI - MERMERLİ
MAKE UP REFRIGERATORS - W/MARBLE

150 GL

Setüstü saladbar fiyatı ayrıca belirtilmiştir.
Saladbar price is extra

158M4



KOD / CODE	°C	(MM)	it	⏻	kg	(KW)	❄️	GN 1/4-150	PASLANMAZ TİPİ S.S. TYPE	€
AIM 158M3	- 2 / + 8	1500x800x1080/1500	330	230V - 50Hz	146	0,321	R134A	6	304	-
AIM 158M4	- 2 / + 8	1500x800x1080/1500	330	230V - 50Hz	146	0,321	R134A	6	430	-
AIM 208M3	- 2 / + 8	2000x800x1080/1500	515	230V - 50Hz	247	0,336	R134A	10	304	-
AIM 208M4	- 2 / + 8	2000x800x1080/1500	515	230V - 50Hz	247	0,336	R134A	10	430	-
AIM 150 GL	- 2 / + 8	1500x340x440	-	230V - 50Hz	247	0,2	R134A	6	430	-
AIM 200 GL	- 2 / + 8	2000x340x440	-	230V - 50Hz	247	0,2	R134A	10	430	-
AIM 250 GL	- 2 / + 8	2500x340x440	-	230V - 50Hz	262	0,2	R134A	12	430	-

 R290 İstenildiği takdirde fiyatlara %3 ilave edilir. / For R290 Refrigerant gas, price increase is 3%.

TEKNİK DETAYLAR / TECHNICAL DETAILS

TR

- Dış ortam sıcaklığı +43°C %65 nem oranı
- Eşit sıcaklık dağılımı için yeni tasarım
- Sıfır ODP enjekte 42 kg/m³ çevre dostu poliüretan izolasyon
- Kolay okunur ekranlı dijital kontrol
- Ergonomik kapı ve kulpu sayesinde kolay açılma ve temizlik
- Patentli 'Icecool' soğutma sistemi ile mükemmel verim ve enerji sarfiyatı
- Sıcak gaz defrost sistemi
- Atık ısı geri kazanımlı kondanzasyon
- Tüm buzdolapların marine versiyonları mevcuttur.

EN

- Designed to operate in 43°C ambient %65 humidity
- New design for equal temperature distribution
- Zero ODP Injected 42 kg/m³ Polyurethane Insulation
- Digital controller with easy read screen
- Ergonomic door and handle designed for ease of opening and cleaning
- Icecool refrigeration system designed to be most technologically advanced and energy efficient yet
- Hot gas defrost system
- Waste heat recovery condensate vaporiser system
- All refrigerators can be produced in marine version

AIM 158 40X60

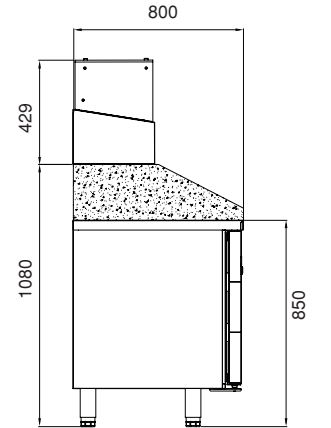
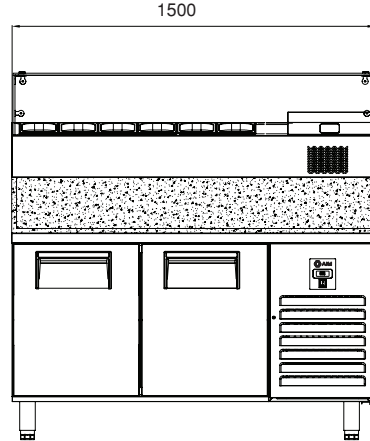
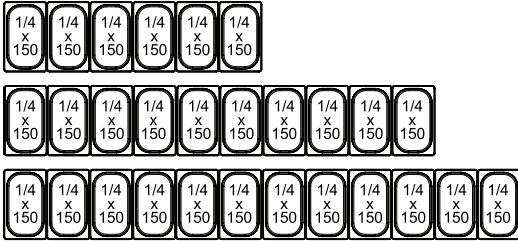

OPSİYONLAR / OPTIONS

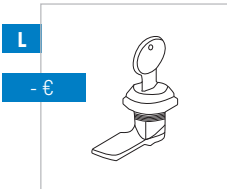

L
- €
Dolap Kilidi /
Cabinet Lock



W
- €
Tekerlekli - Wheels

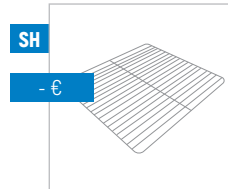

SH
- €
Raf ve Raf Kızağı /
Shelf and Shelf Holder

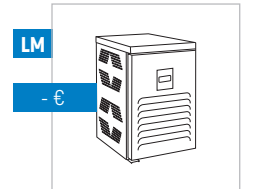

LM
- €
Sol Motor / Left Motor



Gastronom küvetler fiyata dahil değildir.
Gn containers are not included in the price.

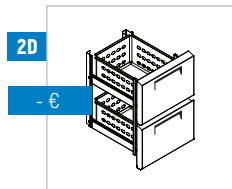

2D
- €
1/2 Çekmece - 1/2 Drawers

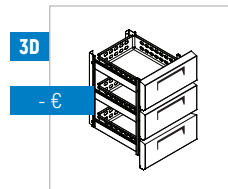

3D
- €
1/3 Çekmece - 1/3 Drawers

AIM

AIM SB-PL-GL



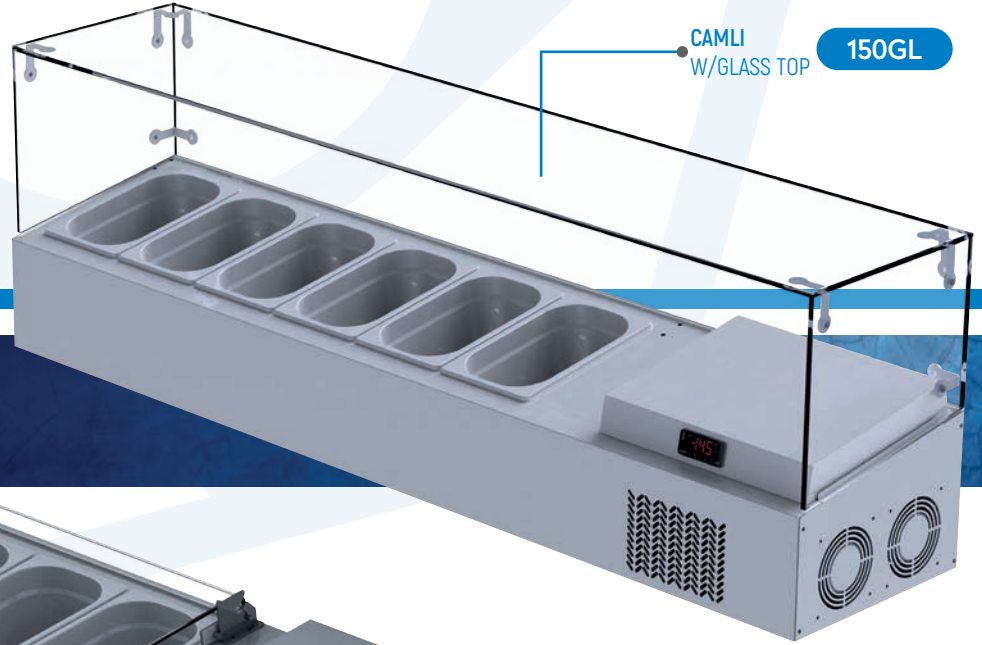

SETÜSTÜ SALADBARLAR
COUNTERTOP SALADBAR



132 PL

PLEKSİ KAPAK
PLEXY COVER



KOD / CODE	°C	 [MM]			 [kW]	GN 1/4-150	€
AIM 132 GL	-2 / +8	1320x340x450	230V - 50Hz	34	0,2 kW	5	-
AIM 150 GL	-2 / +8	1500x340x450	230V - 50Hz	36	0,2 kW	6	-
AIM 178 GL	-2 / +8	1780x340x450	230V - 50Hz	42	0,2 kW	8	-
AIM 200 GL	-2 / +8	2000x340x450	230V - 50Hz	45	0,2 kW	10	-
AIM 225 GL	-2 / +8	2250x340x450	230V - 50Hz	53	0,2 kW	11	-
AIM 250 GL	-2 / +8	2500x340x450	230V - 50Hz	55	0,2 kW	12	-
AIM 132 PL	-2 / +8	1320x340x300	230V - 50Hz	34	0,2 kW	5	-
AIM 150 PL	-2 / +8	1500x340x300	230V - 50Hz	36	0,2 kW	6	-
AIM 178 PL	-2 / +8	1780x340x300	230V - 50Hz	42	0,2 kW	8	-
AIM 200 PL	-2 / +8	1780x340x300	230V - 50Hz	45	0,2 kW	10	-
AIM 225 PL	-2 / +8	2250x340x300	230V - 50Hz	53	0,2 kW	11	-
AIM 250 PL	-2 / +8	2250x340x300	230V - 50Hz	55	0,2 kW	12	-

 R290 İstenildiği takdirde fiyatlara %3 ilave edilir. / For R290 Refrigerant gas, price increase is 3%.

TEKNİK DETAYLAR / TECHNICAL DETAILS

TR

- Dış ortam sıcaklığı +43°C %65 nem oranı
- Eşit sıcaklık dağılımı için yeni tasarım
- Sıfır ODP enjekte 42 kg/m³ çevre dostu poliüretan izolasyon
- Kolay okunur ekranlı dijital kontrol
- Ergonomik kapı ve kulpu sayesinde kolay açılma ve temizlik
- Patentli 'Icecool' soğutma sistemi ile mükemmel verim ve enerji sarfiyatı
- Sıcak gaz defrost sistemi
- Atık ısı geri kazanımlı kondanzasyon
- Tüm buzdolapların marine versiyonları mevcuttur.
- **14 Adet 1/4-100 Gn kapasitesi.**

EN

- Designed to operate in 43°C ambient %65 humidity
- New design for equal temperature distribution
- Zero ODP Injected 42 kg/m³ Polyurethane Insulation
- Digital controller with easy read screen
- Ergonomic door and handle designed for ease of opening and cleaning
- Icecool refrigeration system designed to be most technologically advanced and energy efficient yet
- Hot gas defrost system
- Waste heat recovery condensate vaporiser system
- All refrigerators can be produced in marine version
- **14 No's 1/4-100mm Gn capacity**

AIM SB-PI -GI

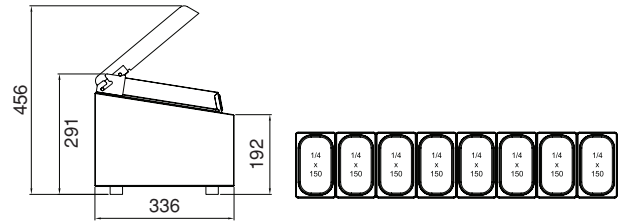
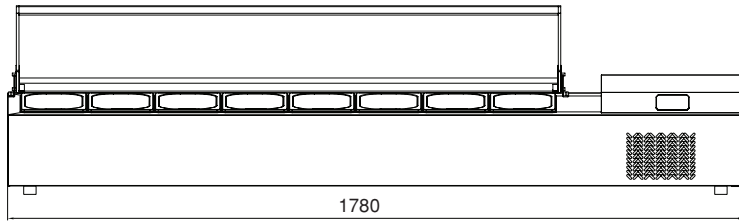
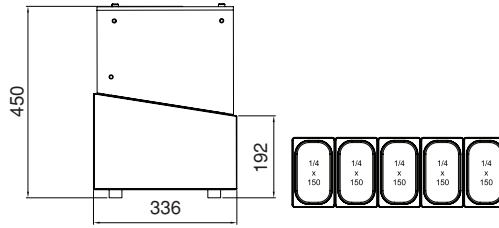
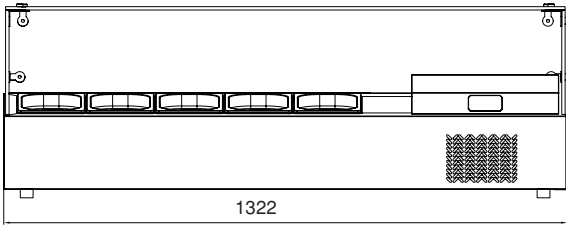

OPSİYONLAR / OPTIONS



Gastronom küvetler fiyata dahil değildir.
Gn containers are not included in the price.

ÖZEL SERİ SOĞUTUCULAR

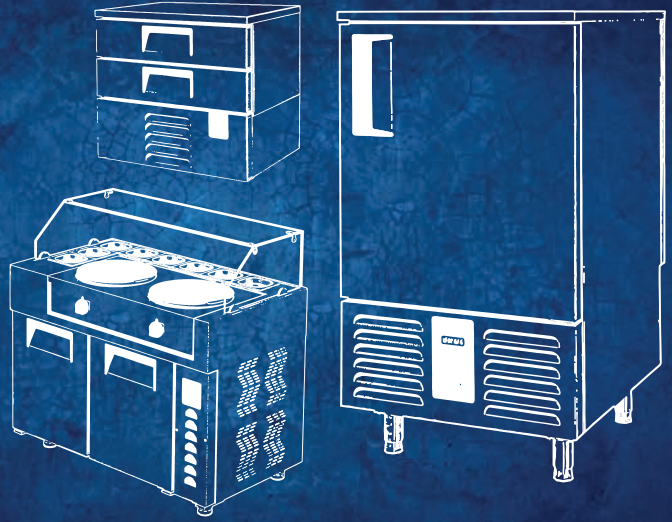

SPECIAL COLDLINE

YENİ KONDENSER SİSTEMİ NEW CONDENSER SYSTEM



CLASSIC



AIMCLEAR

Temizlik gerektirmeyen kondenser
Stayclear Condenser

ENERJİ TASARRUFU SAVING ENERGY



Düşük enerji tüketimi sağlayan çevre dostu HFC içermeyen poliüretan izolasyon
Eco friendly, HFC - free polyurethane insulation providing low energy consumption

SICAK GAZ DEFROST İLE KARLANMAYAN EVAPARATÖR EVAPARATOR DOES NOT SNOW THROUGH HOT GAS DEFROST

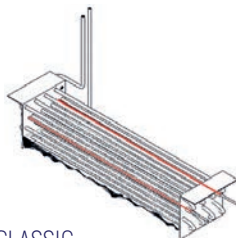

CLASSIC

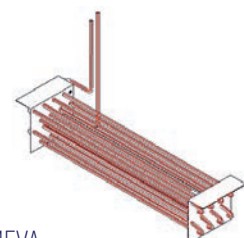

AIMEVA

AIM

AIM 21DR / 11DR

ÇEKMECELİ SOĞUTUCU VE DONDURUCULAR
DRAWER TYPE COOLING & FREEZING UNITS

NEW PRODUCT

21DR

11DR



KOD / CODE	°C	↑ [MM]	⏻	kg	⚡ (kW)	❄️	KAPASİTE CAPACITY GN 2/1-100	KAPASİTE CAPACITY GN 2/1-200	PASLANMAZ TİPİ S.S. TYPE	€
AIM 21DR3	+8 / -20	940x700x850	230V - 50Hz	153	0,90	R290	2	-	304	-
AIM 21DR4	+8 / -20	940x700x850	230V - 50Hz	153	0,90	R290	2	-	430	-
AIM 11DR3	+8 / -20	940x700x850	230V - 50Hz	178	0,90	R290	-	1	304	-
AIM 11DR4	+8 / -20	940x700x850	230V - 50Hz	178	0,90	R290	-	1	430	-

 R290 İstenildiği takdirde fiyatlara %3 ilave edilir. / For R290 Refrigerant gas, price increase is 3%.

TEKNİK DETAYLAR / TECHNICAL DETAILS

TR

- Dış ortam sıcaklığı +43°C %65 nem oranı
- Eşit sıcaklık dağılımı için yeni tasarım
- Sıfır ODP enjekte 42 kg/m³ çevre dostu poliüretan izolasyon
- Kolay okunur ekranlı dijital kontrol
- Ergonomik kapı ve kulpu sayesinde kolay açılma ve temizlik
- Patentli 'Icecool' soğutma sistemi ile mükemmel verim ve enerji sarfiyatı
- Sıcak gaz defrost sistemi
- Atık ısı geri kazanımlı kondanzasyon
- Tüm buzdolapların marine versiyonları mevcuttur.
- Marine versiyonları 'Icecool marine' sistemi, marine ayak ve raflar içerir.

EN

- Designed to operate in 43°C ambient %65 humidity
- New design for equal temperature distribution
- Zero ODP Injected 42 kg/m³ Polyurethane Insulation
- Digital controller with easy read screen
- Ergonomic door and handle designed for ease of opening and cleaning
- Icecool refrigeration system designed to be most technologically advanced and energy efficient yet
- Hot gas defrost system
- Waste heat recovery condensate vaporiser system
- All refrigerators can be produced in marine version
- Marine version includes 'Icecool marine' system, legs and shelves

AIM 21DR / 11DR

21DR

11DR

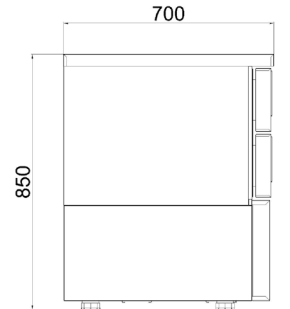
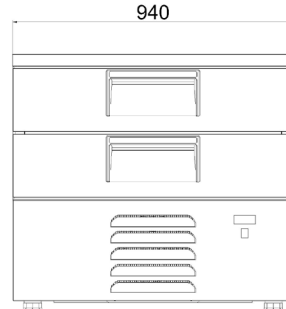
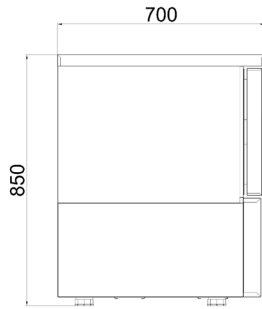
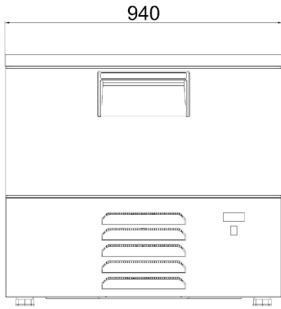

OPSİYONLAR / OPTIONS

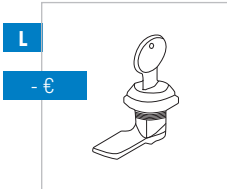

Dolap Kilidi /
Cabinet Lock



Tekerlekli - Wheels

AIM

AIM 800 USA

ÇEKMECELİ PİZZA HAZIRLIK BUZDOLABI
DRAWER TYPE PIZZA PREPERATION COUNTER

NEW PRODUCT

12X1/3 - 100 GN
KAPATİTESİ

12X1/3 - 100 GN
CAPACITY

İZOLASYONLU ÜST
KAPAK

INSULATED TOP
COVER



2/1 - 200 GN
KAPASİTESİ

2/1 - 200 GN
CAPACITY

KOD / CODE	°C	↑ [MM]	lit	⏻	kg	⚡ (KW)	❄️	KAPASİTE CAPACITY GN 2/1-200	PASLANMAZ TİPİ S.S. TYPE	€
AIM 800USA-3	-2 / +8	2372x810x1090	800	230V - 50Hz	250	0,76	R134A	6	304	-
AIM 800USA-4	-2 / +8	2372x810x1090	800	230V - 50Hz	250	0,76	R134A	6	430	-

R290 İstenildiği takdirde fiyatlara %3 ilave edilir. / For R290 Refrigerant gas, price increase is 3%.

TEKNİK DETAYLAR / TECHNICAL DETAILS

TR

- Dış ortam sıcaklığı +43°C %65 nem oranı
- Eşit sıcaklık dağılımı için yeni tasarım
- Sıfır ODP enjekte 42 kg/m³ çevre dostu poliüretan izolasyon
- Kolay okunur ekranlı dijital kontrol
- Ergonomik kapı ve kulpu sayesinde kolay açılma ve temizlik
- Patentli 'Icecool' soğutma sistemi ile mükemmel verim ve enerji sarfiyatı
- Sıcak gaz defrost sistemi
- Atık ısı geri kazanımlı kondanzasyon
- **12 Adet 1/3-100 Gn saladbar kapasitesi**
- **6 Adet 2/1 Gn kapasitesi.**

EN

- Designed to operate in 43°C ambient %65 humidity
- New design for equal temperature distribution
- Zero ODP Injected 42 kg/m³ Polyurethane Insulation
- Digital controller with easy read screen
- Ergonomic door and handle designed for ease of opening and cleaning
- Icecool refrigeration system designed to be most technologically advanced and energy efficient yet
- Hot gas defrost system
- Waste heat recovery condensate vaporiser system
- **12 No's 1/3-100 Gn saladbar capacity**
- **6 No's 2/1 Gn capacity.**

AIM 800 USA

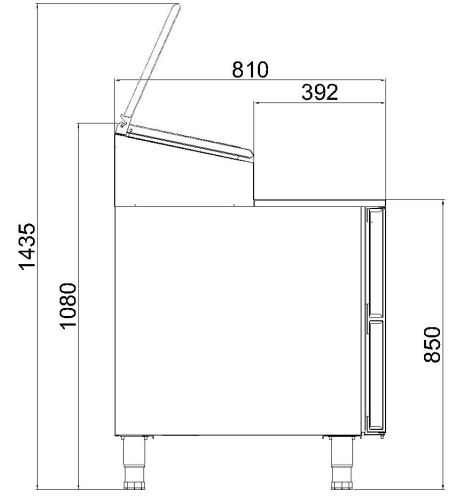
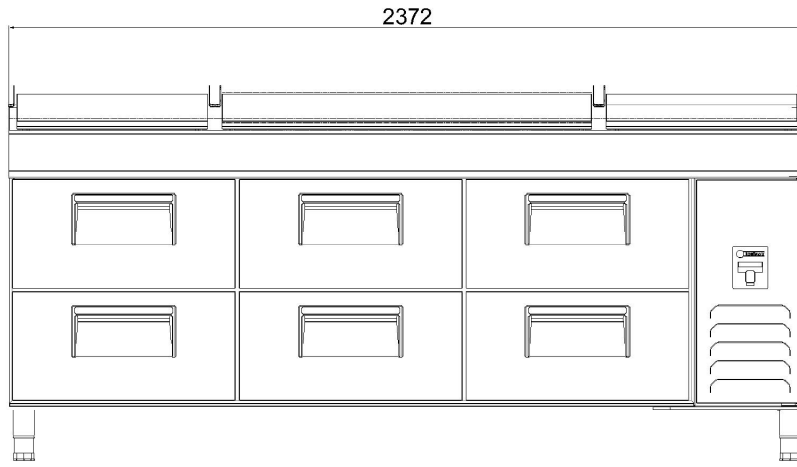

OPSİYONLAR / OPTIONS

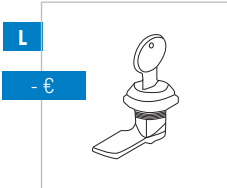

L
- €
Dolap Kilidi /
Cabinet Lock

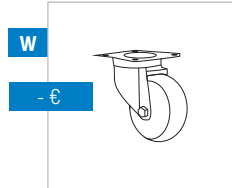

W
- €
Tekerlekli - Wheels

AIM

SBR/G 04-05-06

SERVİS BUZDOLAPLARI - 2, 3 ve 4 KAPILI - CAM ÜST RAFLI
SERVICE REFRIGERATORS - W/2, 3 and 4 DOORS - GLASS TOP SHELF

KOD / CODE	°C	3D [MM]	lit	Power	kg	(KW)	Refrigerant	KAPASİTE CAPACITY GN 1/1-150	PASLANMAZ TİPİ S.S. TYPE	€
AIM 15SBR3-G	-2 / +8	1500x700x850/1230	330	230V - 50Hz	153	0,32	R134A	4	304	-
AIM 15SBR4-G	-2 / +8	1500x700x850/1230	330	230V - 50Hz	153	0,32	R134A	4	430	-
AIM 20SBR3-G	-2 / +8	2000x700x850/1230	515	230V - 50Hz	178	0,34	R134A	5	304	-
AIM 20SBR4-G	-2 / +8	2000x700x850/1230	515	230V - 50Hz	178	0,34	R134A	5	430	-
AIM 25SBR3-G	-2 / +8	2500x700x850/1230	650	230V - 50Hz	195	0,50	R134A	6	304	-
AIM 25SBR4-G	-2 / +8	2500x700x850/1230	650	230V - 50Hz	195	0,50	R134A	6	430	-

 R290 İstenildiği takdirde fiyatlara %3 ilave edilir. / For R290 Refrigerant gas, price increase is 3%.

TEKNİK DETAYLAR / TECHNICAL DETAILS

TR

- Dış ortam sıcaklığı +43°C %65 nem oranı
- Eşit sıcaklık dağılımı için yeni tasarım
- Sıfır ODP enjekte 42 kg/m³ çevre dostu poliüretan izolasyon
- Kolay okunur ekranlı dijital kontrol
- Ergonomik kapı ve kulpu sayesinde kolay açılma ve temizlik
- Patentli 'Icecool' soğutma sistemi ile mükemmel verim ve enerji sarfiyatı
- Sıcak gaz defrost sistemi
- Atık ısı geri kazanımlı kondanzasyon
- Tüm buzdolapların marine versiyonları mevcuttur.
- Marine versiyonları 'Icecool marine' sistemi, marine ayak ve raflar içerir.

EN

- Designed to operate in 43°C ambient %65 humidity
- New design for equal temperature distribution
- Zero ODP Injected 42 kg/m³ Polyurethane Insulation
- Digital controller with easy read screen
- Ergonomic door and handle designed for ease of opening and cleaning
- Icecool refrigeration system designed to be most technologically advanced and energy efficient yet
- Hot gas defrost system
- Waste heat recovery condensate vaporiser system
- All refrigerators can be produced in marine version
- Marine version includes 'Icecool marine' system, legs and shelves

SBR/G 04-05-07

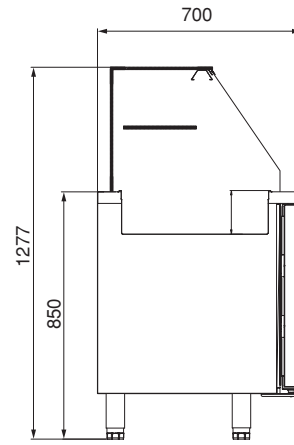
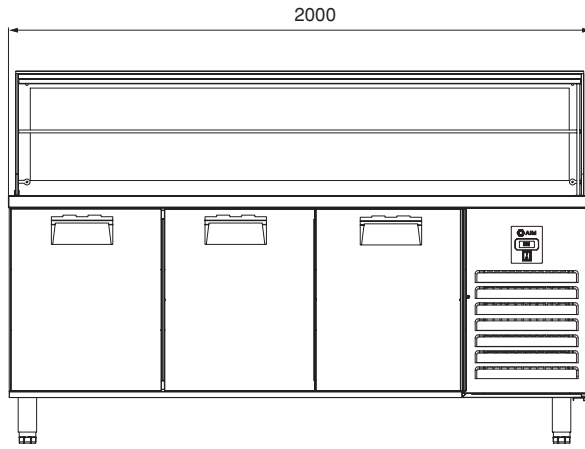

OPSİYONLAR / OPTIONS

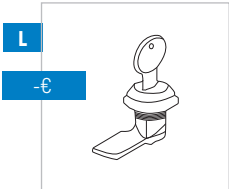

L
- €
Dolap Kilidi /
Cabinet Lock

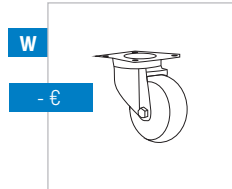

W
- €
Tekerlekli - Wheels

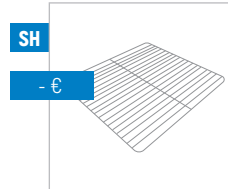

SH
- €
Raf ve Raf Kızağı /
Shelf and Shelf Holder

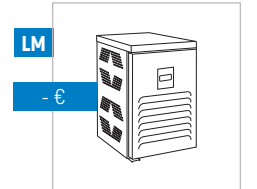

LM
- €
Sol Motor / Left Motor



1/1-150mm
Gastronom kütetler fiyata dahil değildir.
Gn containers are not included in the price.

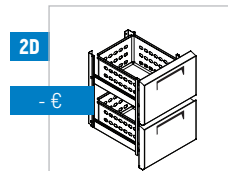

2D
- €
1/2 Çekmece - 1/2 Drawers

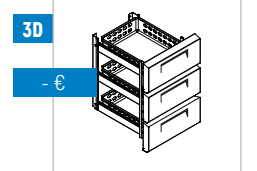









3D
- €
1/3 Çekmece -
1/3 Drawers

AIM

SBR 04-05-07

SERVİS BUZDOLAPLARI - 2, 3 ve 4 KAPILI
SERVICE REFRIGERATORS - W/2, 3 and 4 DOORS



KOD / CODE		 (MM)	 lit		 kg	 (KW)		 KAPASİTE CAPACITY GN 1/1-150	PASLANMAZ TİPİ S.S. TYPE	€
AIM 15SBR3	-2 / +8	1500x700x850	330	230V - 50Hz	153	0,32	R134A	4	304	-
AIM 15SBR4	-2 / +8	1500x700x850	330	230V - 50Hz	153	0,32	R134A	4	430	-
AIM 20SBR3	-2 / +8	2000x700x850	515	230V - 50Hz	178	0,34	R134A	5	304	-
AIM 20SBR4	-2 / +8	2000x700x850	515	230V - 50Hz	178	0,34	R134A	5	430	-
AIM 25SBR3	-2 / +8	2500x700x850	650	230V - 50Hz	195	0,50	R134A	6	304	-
AIM 25SBR4	-2 / +8	2500x700x850	650	230V - 50Hz	195	0,50	R134A	6	430	-

 R290 İstenildiği takdirde fiyatlara %3 ilave edilir. / For R290 Refrigerant gas, price increase is 3%.

TEKNİK DETAYLAR / TECHNICAL DETAILS

TR

- Dış ortam sıcaklığı +43°C %65 nem oranı
- Eşit sıcaklık dağılımı için yeni tasarım
- Sıfır ODP enjekte 42 kg/m³ çevre dostu poliüretan izolasyon
- Kolay okunur ekranlı dijital kontrol
- Ergonomik kapı ve kulpu sayesinde kolay açılma ve temizlik
- Patentli 'Icecool' soğutma sistemi ile mükemmel verim ve enerji sarfiyatı
- Sıcak gaz defrost sistemi
- Atık ısı geri kazanımlı kondanzasyon
- Tüm buzdolapların marine versiyonları mevcuttur.
- Marine versiyonları 'Icecool marine' sistemi, marine ayak ve raflar içerir.

EN

- Designed to operate in 43°C ambient %65 humidity
- New design for equal temperature distribution
- Zero ODP Injected 42 kg/m³ Polyurethane Insulation
- Digital controller with easy read screen
- Ergonomic door and handle designed for ease of opening and cleaning
- Icecool refrigeration system designed to be most technologically advanced and energy efficient yet
- Hot gas defrost system
- Waste heat recovery condensate vaporiser system
- All refrigerators can be produced in marine version
- Marine version includes 'Icecool marine' system, legs and shelves

SBR 04-05-07

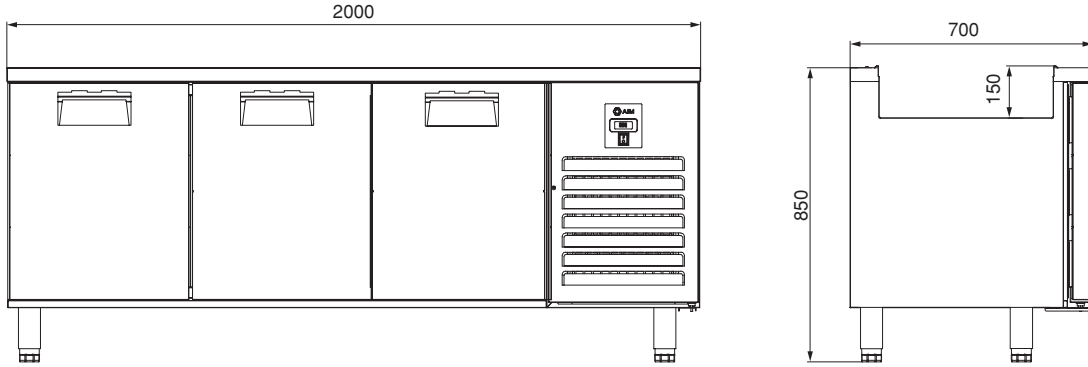

OPSİYONLAR / OPTIONS

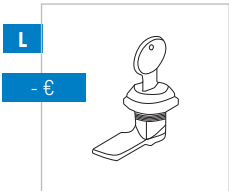

L
- €
Dolap Kilidi /
Cabinet Lock



W
- €
Tekerlekli - Wheels

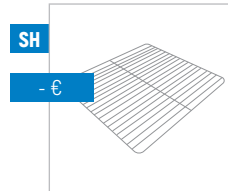

SH
- €
Raf ve Raf Kızağı /
Shelf and Shelf Holder

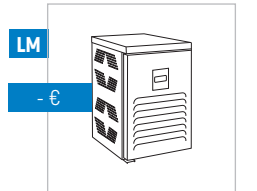

LM
- €
Sol Motor / Left Motor



1/1-150mm

Gastronom kütetler fiyata dahil değildir.
Gn containers are not included in the price.

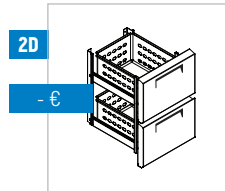

2D
- €
1/2 Çekmece - 1/2 Drawers

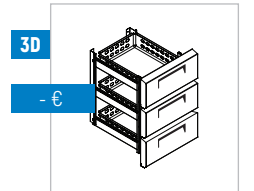







3D
- €
1/3 Çekmece - 1/3 Drawers

AIM

156DP/G-157DP/G

TEZGAH TİP BUZDOLAPLARI - ÖNÜ CAMLI
COUNTER TYPE REFRIGERATORS - W/FRONT GLASS

KOD / CODE		 (MM)	 lt		 kg	 (KW)	PASLANMAZ TİPİ S.S. TYPE	€
AIM 156DP3-G	- 2 / + 8	1500x600x850	275	230V - 50Hz	103	0,321	304	-
AIM 156DP4-G	- 2 / + 8	1500x600x850	275	230V - 50Hz	103	0,321	430	-
AIM 157DP3-G	- 2 / + 8	1500x700x850	330	230V - 50Hz	107	0,321	304	-
AIM 157DP4-G	- 2 / + 8	1500x700x850	330	230V - 50Hz	107	0,321	430	-
AIM 206DP3-G	- 2 / + 8	2000x600x850	440	230V - 50Hz	132	0,336	304	-
AIM 206DP4-G	- 2 / + 8	2000x600x850	440	230V - 50Hz	132	0,336	430	-
AIM 207DP3-G	- 2 / + 8	2000x700x850	515	230V - 50Hz	137	0,336	304	-
AIM 207DP4-G	- 2 / + 8	2000x700x850	515	230V - 50Hz	137	0,336	430	-
AIM 256DP3-G	- 2 / + 8	2500x600x850	560	230V - 50Hz	196	0,501	304	-
AIM 256DP4-G	- 2 / + 8	2500x600x850	560	230V - 50Hz	196	0,501	430	-
AIM 257DP3-G	- 2 / + 8	2500x700x850	650	230V - 50Hz	204	0,501	304	-
AIM 257DP4-G	- 2 / + 8	2500x700x850	650	230V - 50Hz	204	0,501	430	-

 R290 İstenildiği takdirde fiyatlara %3 ilave edilir. / For R290 Refrigerant gas, price increase is 3%.

TEKNİK DETAYLAR / TECHNICAL DETAILS

TR

- Dış ortam sıcaklığı +43°C %65 nem oranı
- Eşit sıcaklık dağılımı için yeni tasarım
- Sıfır ODP enjekte 42 kg/m³ çevre dostu poliüretan izolasyon
- Kolay okunur ekranlı dijital kontrol
- Ergonomik kapı ve kulpu sayesinde kolay açılma ve temizlik
- Patentli 'Icecool' soğutma sistemi ile mükemmel verim ve enerji sarfiyatı
- Sıcak gaz defrost sistemi
- Atık ısı geri kazanımlı kondanzasyon
- Tüm buzdolapların marine versiyonları mevcuttur.

EN

- Designed to operate in 43°C ambient %65 humidity
- New design for equal temperature distribution
- Zero ODP Injected 42 kg/m³ Polyurethane Insulation
- Digital controller with easy read screen
- Ergonomic door and handle designed for ease of opening and cleaning
- Icecool refrigeration system designed to be most technologically advanced and energy efficient yet
- Hot gas defrost system
- Waste heat recovery condensate vaporiser system
- All refrigerators can be produced in marine version

156DP/G - 157DP/G

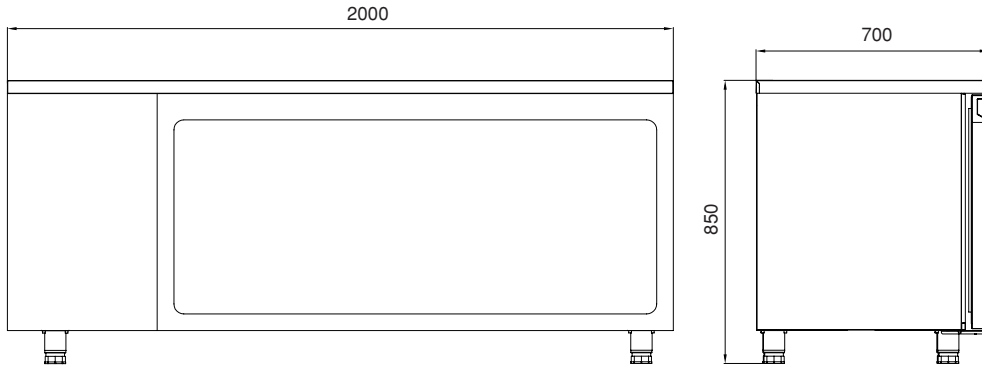

OPSİYONLAR / OPTIONS

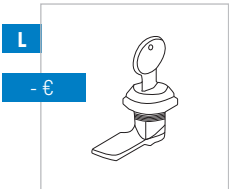

Dolap Kilidi / Cabinet Lock



Cam Kapı / Glass Door

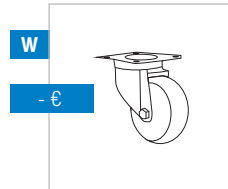

Tekerlekli - Wheels

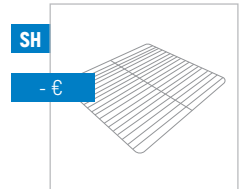







Raf ve Raf Kızağı / Shelf and Shelf Holder

AIM

AIM CR-127

KREP BUZDOLAPLARI
CREP TABLE REFRIGERATORS



KOD / CODE		 (MM)				 (KW)	GN 1/6-150	PASLANMAZ TIPI S.S. TYPE	€
AIM 127CR3	- 2 / + 8	1250x700x1330	330	230V - 50Hz	107	0,357	8	304	-
AIM 127CR4	- 2 / + 8	1250x700x1330	330	230V - 50Hz	107	0,357	8	430	-

 R290 İstenildiği takdirde fiyatlara %3 ilave edilir. / For R290 Refrigerant gas, price increase is 3%.

TEKNİK DETAYLAR / TECHNICAL DETAILS

TR

- Dış ortam sıcaklığı +43°C %65 nem oranı
- Eşit sıcaklık dağılımı için yeni tasarım
- Sıfır ODP enjekte 42 kg/m³ çevre dostu poliüretan izolasyon
- Kolay okunur ekranlı dijital kontrol
- Ergonomik kapı ve kulpu sayesinde kolay açılma ve temizlik
- Patentli 'Icecool' soğutma sistemi ile mükemmel verim ve enerji sarfiyatı
- Sıcak gaz defrost sistemi
- Atık ısı geri kazanımlı kondanzasyon
- Tüm buzdolapların marine versiyonları mevcuttur.
- **8 Adet 1/4-100 Gn kapasitesi.**

EN

- Designed to operate in 43°C ambient %65 humidity
- New design for equal temperature distribution
- Zero ODP Injected 42 kg/m³ Polyurethane Insulation
- Digital controller with easy read screen
- Ergonomic door and handle designed for ease of opening and cleaning
- Icecool refrigeration system designed to be most technologically advanced and energy efficient yet
- Hot gas defrost system
- Waste heat recovery condensate vaporiser system
- All refrigerators can be produced in marine version
- **8 No's 1/4-100mm Gn capacity**

AIM CR-127

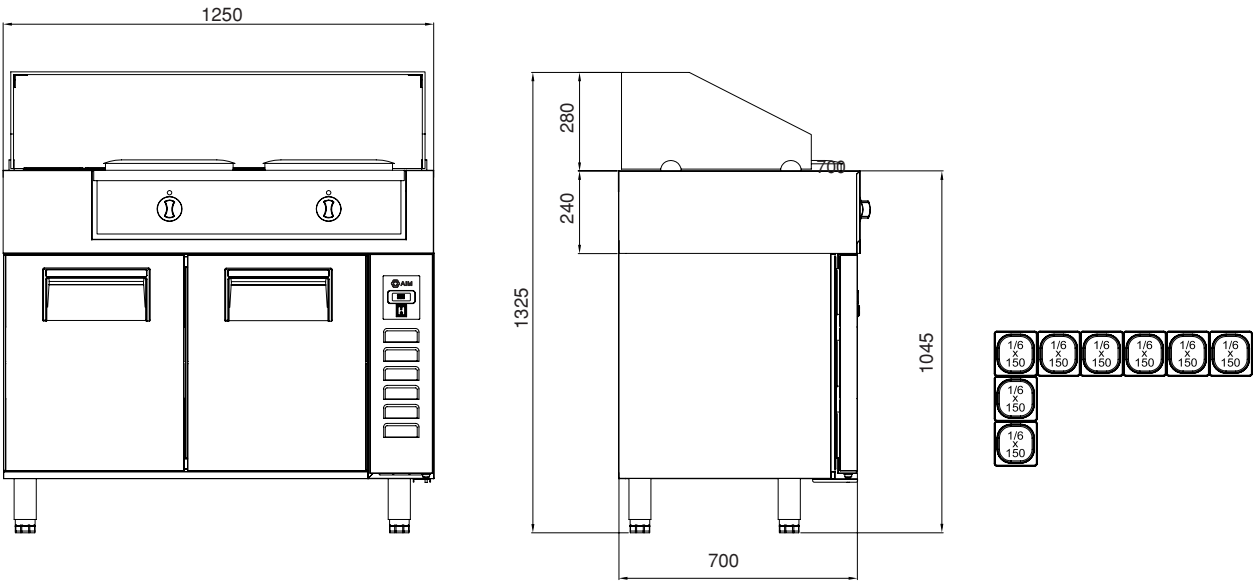

OPSİYONLAR / OPTIONS

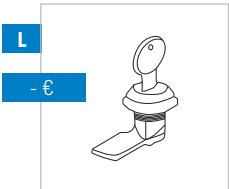

Dolap Kilidi / Cabinet Lock



Cam Kapı / Glass Door

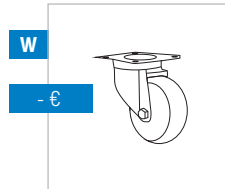

Tekerlekli - Wheels

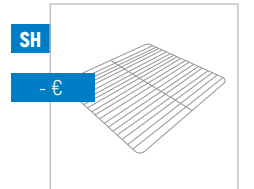

Raf ve Raf Kızağı / Shelf and Shelf Holder



Gastronom küvetler fiyata dahil değildir.
Gn containers are not included in the price.

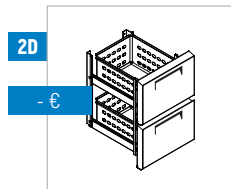

1/2 Çekmece - 1/2 Drawers

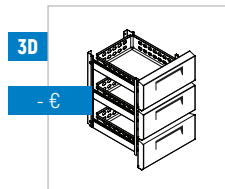

1/3 Çekmece - 1/3 Drawers

AIM

AIM 157PF

HAZIRLIK BUZDOLAPLARI
PREPARING TABLE REFRIGERATORS

KOD / CODE	°C	mm	lt	Power	kg	(KW)	GN 1/6-150	PASLANMAZ TİPİ S.S. TYPE	€
AIM 157PF3	- 2 / + 8	1500x700x1300	330	230V - 50Hz	135	0,357	12	304	-
AIM 157PF4	- 2 / + 8	1500x700x1300	330	230V - 50Hz	135	0,357	12	430	-
AIM 207PF3	- 2 / + 8	2000x700x1300	515	230V - 50Hz	157	0,436	18	304	-
AIM 207PF4	- 2 / + 8	2000x700x1300	515	230V - 50Hz	157	0,436	18	430	-
AIM 257PF3	- 2 / + 8	2500x700x1300	650	230V - 50Hz	186	0,697	24	304	-
AIM 257PF4	- 2 / + 8	2500x700x1300	650	230V - 50Hz	186	0,697	24	430	-

 R290 İstenildiği takdirde fiyatlara %3 ilave edilir. / For R290 Refrigerant gas, price increase is 3%.

TEKNİK DETAYLAR / TECHNICAL DETAILS

TR

- Dış ortam sıcaklığı +43°C %65 nem oranı
- Eşit sıcaklık dağılımı için yeni tasarım
- Sıfır ODP enjekte 42 kg/m³ çevre dostu poliüretan izolasyon
- Kolay okunur ekranlı dijital kontrol
- Ergonomik kapı ve kulpu sayesinde kolay açılma ve temizlik
- Patentli 'Icecool' soğutma sistemi ile mükemmel verim ve enerji sarfiyatı
- Sıcak gaz defrost sistemi
- Atık ısı geri kazanımlı kondanzasyon
- Tüm buzdolapların marine versiyonları mevcuttur.
- **14 Adet 1/4-100 Gn kapasitesi.**

EN

- Designed to operate in 43°C ambient %65 humidity
- New design for equal temperature distribution
- Zero ODP Injected 42 kg/m³ Polyurethane Insulation
- Digital controller with easy read screen
- Ergonomic door and handle designed for ease of opening and cleaning
- Icecool refrigeration system designed to be most technologically advanced and energy efficient yet
- Hot gas defrost system
- Waste heat recovery condensate vaporiser system
- All refrigerators can be produced in marine version
- **14 No's 1/4-100mm Gn capacity**

AIM 157PF

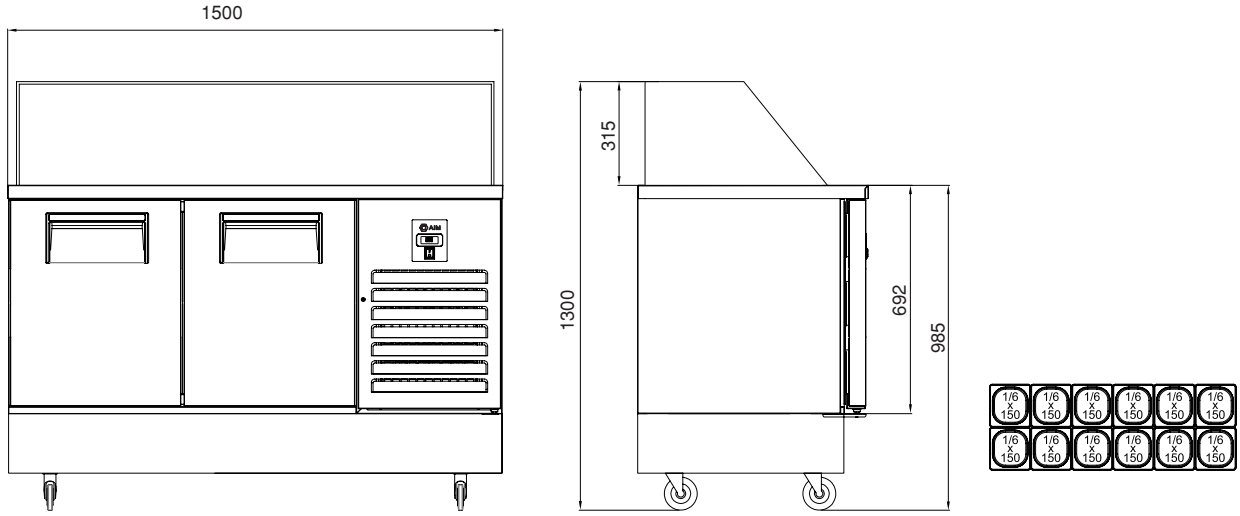

OPSİYONLAR / OPTIONS

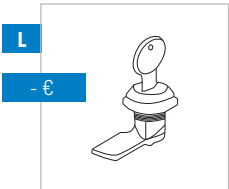

Dolap Kilidi / Cabinet Lock



Cam Kapı / Glass Door

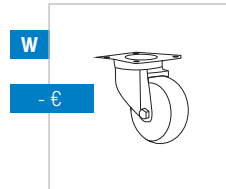

Tekerlekli - Wheels

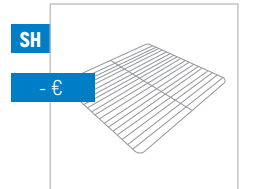

Raf ve Raf Kızağı / Shelf and Shelf Holder



Gastronom küvetler fiyata dahil değildir.
Gn containers are not included in the price.

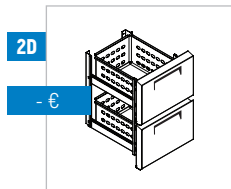

1/2 Çekmece - 1/2 Drawers

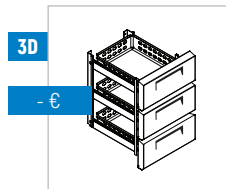

1/3 Çekmece - 1/3 Drawers

AIM

AIM DRY

DRY AGED BUZDOLAPLARI
DRY AGED REFRIGERATORS



- Aktif karbon ve UVC sayesinde antibakteriyel soğutma
Antibacterial cooling with an activated carbon filter and an active UVC light
- 304 Paslanmaz Çelik Raflar
Stainless Steel Shelves
- Nem Kontrolü
Humidity Control
- Rezistanslı Isıcam
Heated Glass



KOD / CODE	°C	3D (MM)	lit	Power	kg	(KW)	R134A	PASLANMAZ TİPİ S.S. TYPE	€
AIM 60DRY	-3 / +5	600X640X820	140	230V - 50Hz	70	0,32	R134A	R404	-
AIM 70DRY	-3 / +5	700x800x2100	610	230V - 50Hz	129	0,76	R134A	R404	-
AIM 14DRY	-3 / +5	1400x800x2100	1340	230V - 50Hz	197	1,20	R134A	R404	-

R290 İstenildiği takdirde fiyatlara %3 ilave edilir. / For R290 Refrigerant gas, price increase is 3%.

TEKNİK DETAYLAR / TECHNICAL DETAILS

TR

- Dış ortam sıcaklığı +43°C %65 nem oranı
- Eşit sıcaklık dağılımı için yeni tasarım
- Sıfır ODP enjekte 42 kg/m³ çevre dostu poliüretan izolasyon
- Kolay okunur ekranlı dijital kontrol
- Ergonomik kapı ve kulpu sayesinde kolay açılma ve temizlik
- Patentli 'Icecool' soğutma sistemi ile mükemmel verim ve enerji sarfiyatı
- Sıcak gaz defrost sistemi
- Atık ısı geri kazanımlı kondanzasyon
- Tüm buzdolapların marine versiyonları mevcuttur.
- Marine versiyonları 'Icecool marine' sistemi, marine ayak ve raflar içerir.

EN

- Designed to operate in 43°C ambient %65 humidity
- New design for equal temperature distribution
- Zero ODP Injected 42 kg/m³ Polyurethane Insulation
- Digital controller with easy read screen
- Ergonomic door and handle designed for ease of opening and cleaning Icecool refrigeration system designed to be most technologically advanced and energy efficient yet
- Hot gas defrost system
- Waste heat recovery condensate vaporiser system
- All refrigerators can be produced in marine version
- Marine version includes 'Icecool marine' system, legs and shelves

AIM DRY

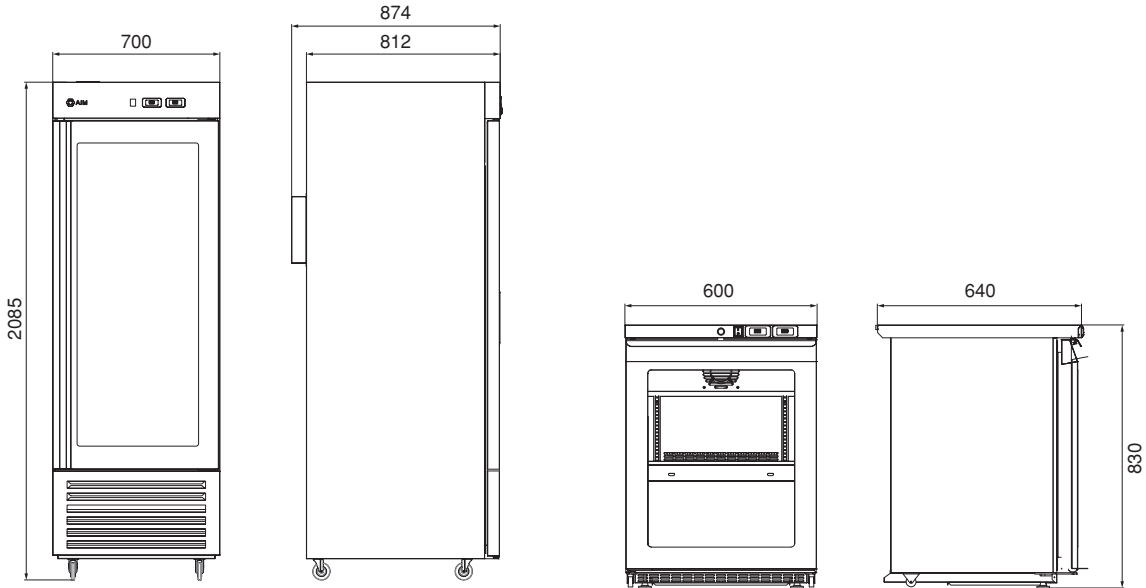

OPSİYONLAR / OPTIONS

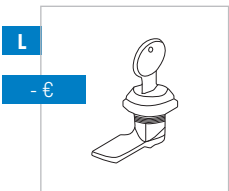

Dolap Kilidi / Cabinet Lock

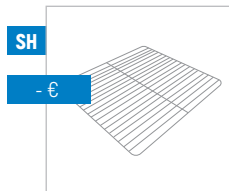

Raf ve Raf Kızağı /
Shelf and Shelf Holder

AIM

AIM BLC

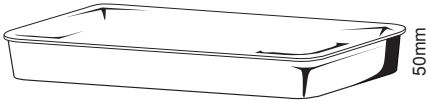
ŞOK DONDURUCULAR
BLAST FREEZER/CHILLER

KOD / CODE	🌡️	❄️	📏 (MM)	GN 1/1-60x40	🔌	📊 (kg)	⚡ (KW)	90dk Soğutma Kapasitesi Chilling Capacity	240dk Dondurma Kapasitesi Freezing Capacity	PASLANMAZ TİPİ S.S. TYPE	€
AIM BLC5-0	+90 / +3	+90 / -18	900x1010x850	5	230V - 50Hz	151	1,32	20 kg	12 kg	304	-
AIM BLC5	+90 / +3	+90 / -18	789x906x1107	5	230V - 50Hz	167	1,47	20 kg	12 kg	304	-
AIM BLC7	+90 / +3	+90 / -18	789x906x1232	7	230V - 50Hz	176	1,65	25 kg	18 kg	304	-
AIM BLC10	+90 / +3	+90 / -18	789x906x1412	10	230V - 50Hz	208	2,41	30 kg	25 kg	304	-
AIM BLC15	+90 / +3	+90 / -18	789x906x1787	15	230V - 50Hz	276	3,94	30 kg	25 kg	304	-

Dış ortam sıcaklığı +32° / +32° Ambient temperature.

 R290 İstenildiği takdirde fiyatlara %3 ilave edilir. / For R290 Refrigerant gas, price increase is 3%.

TEKNİK DETAYLAR / TECHNICAL DETAILS

TR

- Dış ortam sıcaklığı +43°C %65 nem oranı
- Eşit sıcaklık dağılımı için yeni tasarım
- Sıfır ODP enjekte 42 kg/m³ çevre dostu poliüretan izolasyon
- Kolay okunur ekranlı dijital kontrol
- Ergonomik kapı ve kulpu sayesinde kolay açılma ve temizlik
- Patentli 'Icecool' soğutma sistemi ile mükemmel verim ve enerji sarfıyatı
- Sıcak gaz defrost sistemi
- Atık ısı geri kazanımlı kondanzasyon
- Tüm buzdolapların marine versiyonları mevcuttur.
- Marine versiyonları 'Icecool marine' sistemi, marine ayak ve raflar içerir.

EN

- Designed to operate in 43°C ambient %65 humidity
- New design for equal temperature distribution
- Zero ODP Injected 42 kg/m³ Polyurethane Insulation
- Digital controller with easy read screen
- Ergonomic door and handle designed for ease of opening and cleaning
- Icecool refrigeration system designed to be most technologically advanced and energy efficient yet
- Hot gas defrost system
- Waste heat recovery condensate vaporiser system
- All refrigerators can be produced in marine version
- Marine version includes 'Icecool marine' system, legs and shelves

AMBI C

BLC5

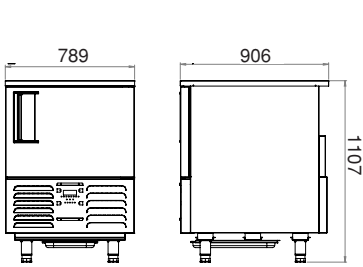

BLC7

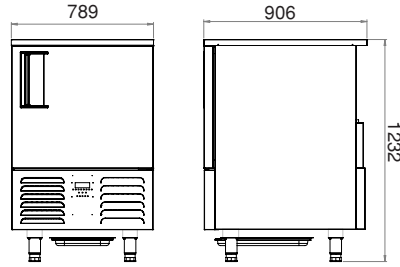

BLC10

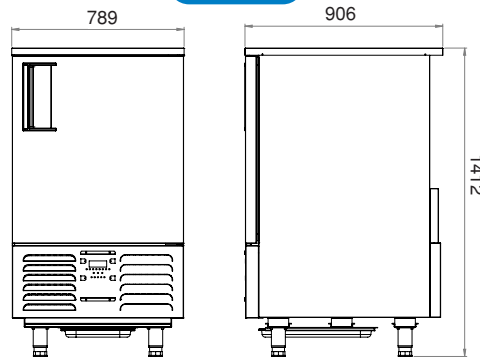

BLC15

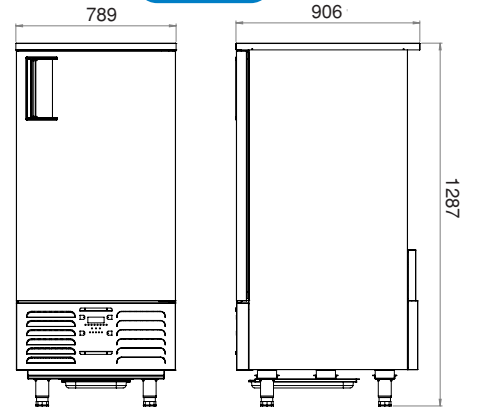

OPSIYONLAR / OPTIONS

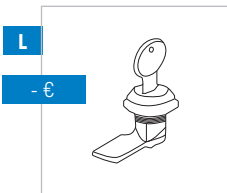

L
- €
Dolap Kilidi /
Cabinet Lock

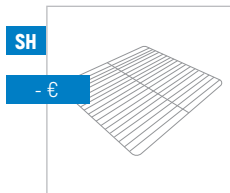

SH
- €
Raf ve Raf Kızağı /
Shelf and Shelf Holder

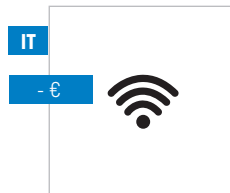

IT
- €
İnternet / Internet



TD
- €
Dokunmatik Ekran /
Touch Digital

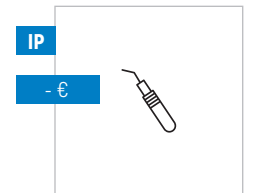

IP
- €
İğne Portlu / Needle
Probe

AIM

AIM BTR / BTF

SOĞUTMALI & DONDURUCULU BANKET ARABALARI
COOLING & FREEZING BANQUET TROLLEYS

NEW PRODUCT



KOD / CODE	🌡️	📏 [MM]	It	🔌	📊 kg	⚡ [KW]	GN 2/1-60	PASLANMAZ TİPİ S.S. TYPE	€
AIM BTR3	- 2 / + 8	789x850x1785	525	230V - 50Hz	131	0,33	12	304	-
AIM BTR4	- 2 / + 8	789x850x1785	525	230V - 50Hz	131	0,33	12	430	-
AIM BTF3	- 18 / - 22	789x850x1785	525	230V - 50Hz	131	0,57	12	304	-
AIM BTF4	- 18 / - 22	789x850x1785	525	230V - 50Hz	131	0,57	12	430	-

 R290 İstenildiği takdirde fiyatlara %3 ilave edilir. / For R290 Refrigerant gas, price increase is 3%.

TEKNİK DETAYLAR / TECHNICAL DETAILS

TR

- Dış ortam sıcaklığı +43°C %65 nem oranı
- Eşit sıcaklık dağılımı için yeni tasarım
- Sıfır ODP enjekte 42 kg/m³ çevre dostu poliüretan izolasyon
- Kolay okunur ekranlı dijital kontrol
- Ergonomik kapı ve kulpu sayesinde kolay açılma ve temizlik
- Patentli 'Icecool' soğutma sistemi ile mükemmel verim ve enerji sarfiyatı
- Sıcak gaz defrost sistemi
- Atık ısı geri kazanımlı kondanzasyon
- Tüm buzdolapların marine versiyonları mevcuttur.
- **12 Adet 2/1 Gn kapasitesi.**

EN

- Designed to operate in 43°C ambient %65 humidity
- New design for equal temperature distribution
- Zero ODP Injected 42 kg/m³ Polyurethane Insulation
- Digital controller with easy read screen
- Ergonomic door and handle designed for ease of opening and cleaning
- Icecool refrigeration system designed to be most technologically advanced and energy efficient yet
- Hot gas defrost system
- Waste heat recovery condensate vaporiser system
- All refrigerators can be produced in marine version
- **12 No's 2/1 Gn capacity**

AIM BTR / BTF

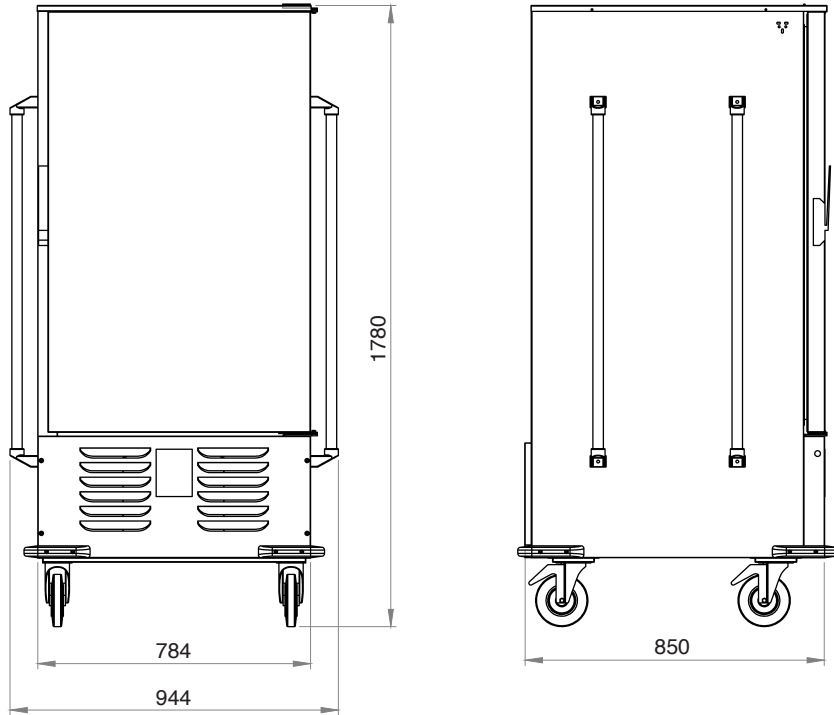

BAR SERİSİ SOĞUTUCULAR



BAR SERIES COOLING LINE

YENİ KONDENSER SİSTEMİ NEW CONDENSER SYSTEM



CLASSIC



AIMCLEAR

Temizlik gerektirmeyen kondenser
Stayclear Condenser

ENERJİ TASARRUFU SAVING ENERGY



Düşük enerji tüketimi sağlayan çevre dostu HFC içermeyen poliüretan izolasyon
Eco friendly, HFC - free polyurethane insulation providing low energy consumption

SICAK GAZ DEFOST İLE KARLANMAYAN EVAPARATÖR EVAPARATOR DOES NOT SNOW THROUGH HOT GAS DEFROST

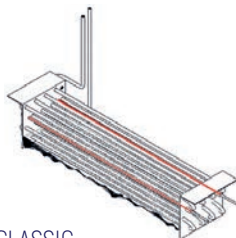

CLASSIC

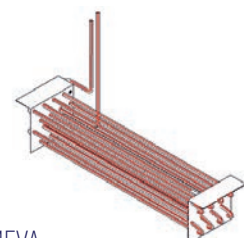

AIMEVA

AIM

AIM 140

TEZGAH ALTI MİNİ BUZDOLAPLARI
UNDERCOUNTER REFRIGERATORS

KOD / CODE	°C	mm	lit	Power	kg	(kW)	Refrigerant	PASLANMAZ TİPİ S.S. TYPE	€
AIM 140R3	-2 / +8	600x640x820	140	230V - 50Hz	62	0,25	R134A	304	-
AIM 140R4	-2 / +8	600x640x820	140	230V - 50Hz	62	0,25	R134A	430	-
AIM 140F3	-10 / -22	600x640x820	140	230V - 50Hz	62	0,25	R404A	304	-
AIM 140F4	-10 / -22	600x640x820	140	230V - 50Hz	62	0,25	R404A	430	-
AIM G140R3	-2 / +8	600x640x820	140	230V - 50Hz	62	0,25	R134A	304	-
AIM G140R4	-2 / +8	600x640x820	140	230V - 50Hz	62	0,25	R134A	430	-
AIM G140F3	-10 / -22	600x640x820	140	230V - 50Hz	62	0,25	R404A	304	-
AIM G140F4	-10 / -22	600x640x820	140	230V - 50Hz	62	0,25	R404A	430	-

 R290 İstenildiği takdirde fiyatlara %3 ilave edilir. / For R290 Refrigerant gas, price increase is 3%.

TEKNİK DETAYLAR / TECHNICAL DETAILS

TR

- Dış ortam sıcaklığı +43°C %65 nem oranı
- Eşit sıcaklık dağılımı için yeni tasarım
- Sıfır ODP enjekte 42 kg/m³ çevre dostu poliüretan izolasyon
- Kolay okunur ekranlı dijital kontrol
- Ergonomik kapı ve kulpu sayesinde kolay açılma ve temizlik
- Patentli 'Icecool' soğutma sistemi ile mükemmel verim ve enerji sarfiyatı
- Sıcak gaz defrost sistemi
- Atık ısı geri kazanımlı kondanzasyon

EN

- Designed to operate in 43°C ambient %65 humidity
- New design for equal temperature distribution
- Zero ODP Injected 42 kg/m³ Polyurethane Insulation
- Digital controller with easy read screen
- Ergonomic door and handle designed for ease of opening and cleaning Icecool refrigeration system designed to be most
- technologically advanced and energy efficient yet
- Hot gas defrost system
- Waste heat recovery condensate vaporiser system

AIM 140

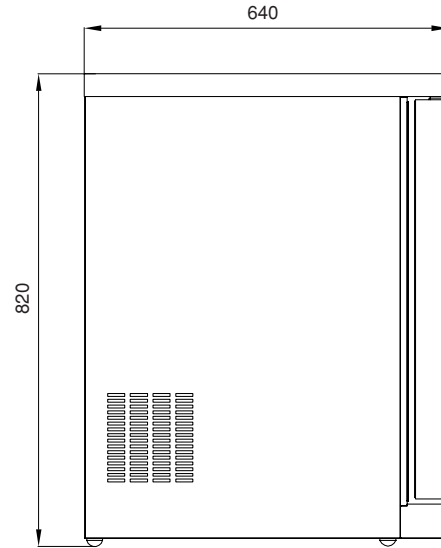
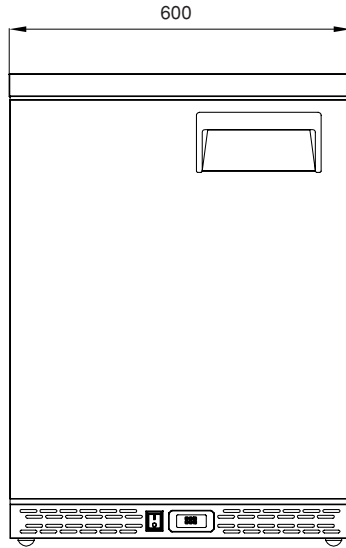

OPSİYONLAR / OPTIONS

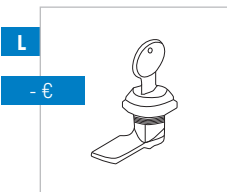

Dolap Kilidi / Cabinet Lock

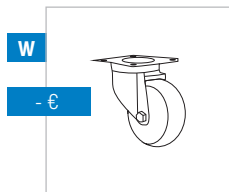

Tekerlekli - Wheels

AIM

AIM BB2 / BB3

BAR TİPİ BUZDOLAPLARI - ÇARPMA KAPI
BAR TYPE CHILLERS - HINGED DOORS

NEW PRODUCT

BB3

BB2



TEKNİK DETAYLAR / TECHNICAL DETAILS

TR

- PVC kaplı galvaniz sac.
- CFC Free soğutma gazı: R 134A / R 404A
- Dış ortam sıcaklığı: +32 °C
- Fanlı soğutma.
- Dijital termometre ve termostat.
- Otomatik defrost.
- Kapılarda kilit.
- Özel kapı menteşe sistemi.
- Temizlenebilir ve sökülebilir manyetik kapı contası. - Çarpma Kapaklı.
- Çalışma Sıcaklığı: 2/10 °C

EN

- PVC coated galvanized steel.
- "CFC Free" refrigerant gas: R 134A / R 404 A
- +32 °C ambient temp.
- Fan cooling.
- Digital thermometer and thermostat.
- Automatic defrosting.
- Lock system in the door.
- Special door hinge system.
- Removable and easy to clean magnetic door. - Hinged Doors.
- Working temperature: 2/10 °C

KOD / CODE	°C	(MM)	lit	Power	kg	(KW)	R134A	€
AIM BB2	+2 / +10	900x525x900	210	230V - 50Hz	90	0,21	R134A	-
AIM BB3	+2 / +10	1350x525x900	310	230V - 50Hz	120	0,25	R134A	-

 R290 İstenildiği takdirde fiyatlara %3 ilave edilir. / For R290 Refrigerant gas, price increase is 3%.

AIM CPC

KOKTEYL HAZIRLIK BUZDOLAPLARI
COCKTAIL PREPARATION COUNTER

NEW PRODUCT

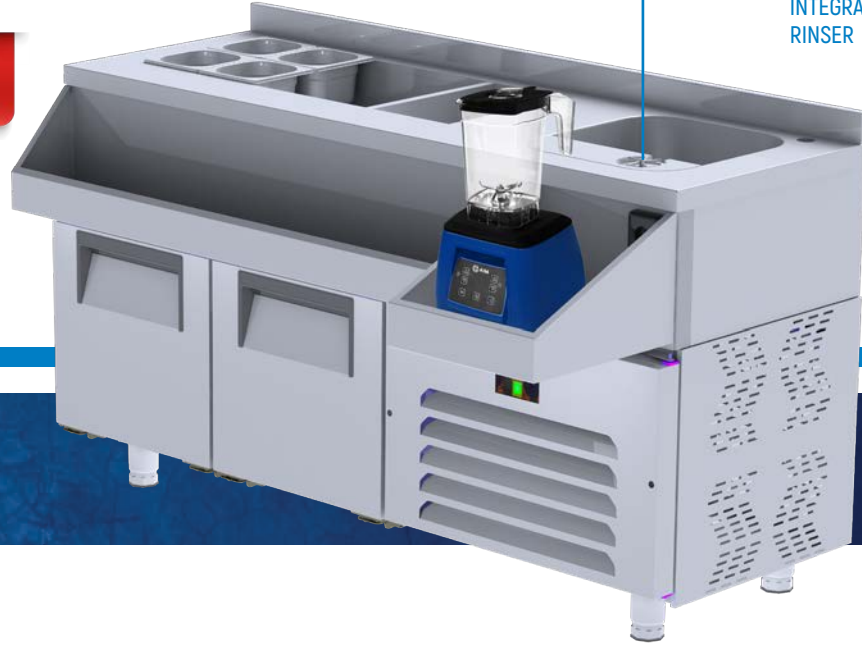

DAHİLİ BARDAK
DURULAMA SİSTEMİ

INTEGRATED GLASS
RINSER

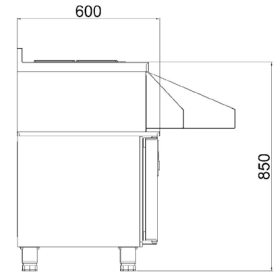
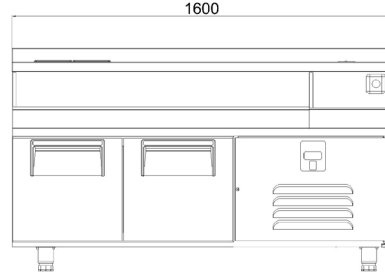
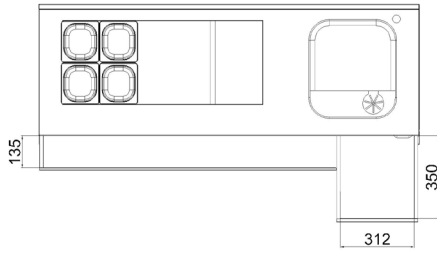

TEKNİK DETAYLAR / TECHNICAL DETAILS

TR

- Tropikal iklim sınıfı +43 °C
- Temizlik gerektirmeyen kondenser
- Sıfır ODP enjekte 42 kg/ m³ çevre dostu poliüretan izolasyon
- Antibakteriyel buz saklama alanı
- Manyetik pompa ile sessiz çalışma
- Elektronik kontrol
- İzalasyonlu buz haznesi
- Ergonomik kapak kulbu
- Patentli nozul sistemi ile daha kısa süreli buz döngüsü
- 1/1 Çekmece kapasitesi

EN

- Tropical class +43 °C
- Stay clear condenser
- Zero ODP injected 42 kg/ m³ polyurethane insulation
- Antibacterial storage area
- Silent operation with magnetic pump
- Electronic control
- Insulated ice chest
- Ergonomic door handle
- Patented nozzle system provides less cycles
- 1/1 Drawer capacity

KOD / CODE	°C	MM	lt	Power	kg	[KW]	R	PASLANMAZ TİPİ S.S. TYPE	€
AIM CPC3	-2 / +8	1600x600x850	190	230V - 50Hz	110	0,17	R134A	304	-
AIM CPC4	-2 / +8	1600x600x850	190	230V - 50Hz	110	0,17	R134A	430	-

R290 İstenildiği takdirde fiyatlara %3 ilave edilir. / For R290 Refrigerant gas, price increase is 3%.

UNLU MAMÜL SOĞUTUCULAR



BAKERY COOLING LINE



AIM

AIM PR60

DİK TİP PATİSERİ BUZDOLABI - 1 KAPILI
VERTICAL PATISSERIE REFRIGERATORS - W/1 DOOR

NEW PRODUCT



40x60 TEPSİ KAPASİTESİ
40x60 TRAY CAPACITY

KOD / CODE	°C	[MM]	lt	Power	kg	[KW]	R	KAPASİTE CAPACITY 40X60	PASLANMAZ TİPİ S.S. TYPE	€
AIM PR60R3	-2 / +8	700x870x2100	610	230V - 50Hz	124	0,32	R134A	22	304	-
AIM PR60R4	-2 / +8	700x870x2100	610	230V - 50Hz	124	0,32	R134A	22	430	-
AIM PR60F3	-10 / -22	700x870x2100	610	230V - 50Hz	124	0,70	R404A	22	304	-
AIM PR60F4	-10 / -22	700x870x2100	610	230V - 50Hz	124	0,70	R404A	22	430	-

 R290 İstenildiği takdirde fiyatlara %3 ilave edilir. / For R290 Refrigerant gas, price increase is 3%.

TEKNİK DETAYLAR / TECHNICAL DETAILS

TR

- Dış ortam sıcaklığı +43°C %65 nem oranı
- Eşit sıcaklık dağılımı için yeni tasarım
- Sıfır ODP enjekte 42 kg/m³ çevre dostu poliüretan izolasyon
- Kolay okunur ekranlı dijital kontrol
- Ergonomik kapı ve kulpu sayesinde kolay açılma ve temizlik
- Patentli 'Icecool' soğutma sistemi ile mükemmel verim ve enerji sarfıyatı
- Sıcak gaz defrost sistemi
- Atık ısı geri kazanımlı kondanzasyon
- 22 adet 40x60 tepsi kapasitesi

EN

- Designed to operate in 43°C ambient %65 humidity
- New design for equal temperature distribution
- Zero ODP Injected 42 kg/m³ Polyurethane Insulation
- Digital controller with easy read screen
- Ergonomic door and handle designed for ease of opening and cleaning
- Icecool refrigeration system designed to be most technologically advanced and energy efficient yet
- Hot gas defrost system
- Waste heat recovery condensate vaporiser system
- 22 no's of 40x60 tray capacity

AIM PR60

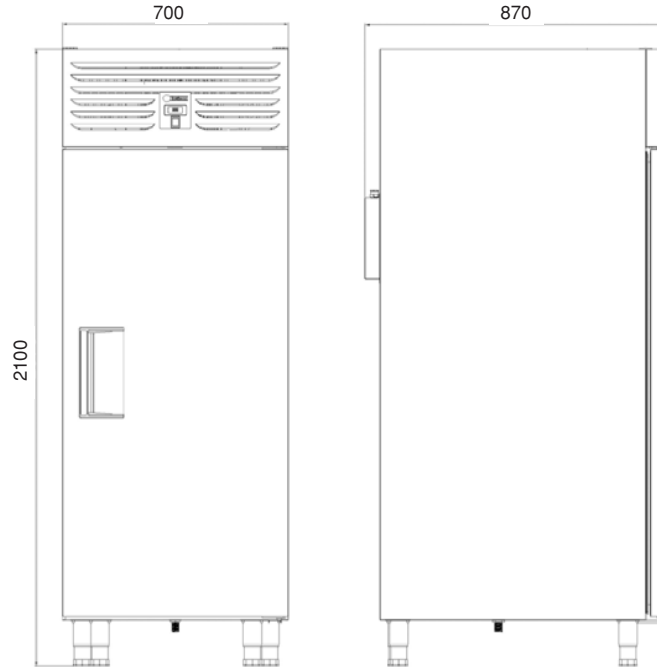

OPSİYONLAR / OPTIONS

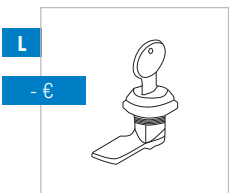

Dolap Kilidi / Cabinet Lock

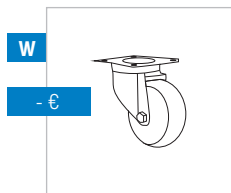

Tekerlekli - Wheels

AIM

AIM PR70

DİK TİP PATİSERİ BUZDOLABI - 1 KAPILI
VERTICAL PATISSERIE REFRIGERATORS - W/1 DOOR

NEW PRODUCT



60x80 TEPSİ KAPASİTESİ
60x80 TRAY CAPACITY

KOD / CODE	°C	(MM)	lit	Power	kg	(KW)	R	KAPASİTE CAPACITY 60X80	PASLANMAZ TİPİ S.S. TYPE	€
AIM PR70R3	-2 / +8	775x1030x2100	730	230V - 50Hz	160	0,32	R134A	22	304	-
AIM PR70R4	-2 / +8	775x1030x2100	730	230V - 50Hz	160	0,32	R134A	22	430	-
AIM PR70F3	-10 / -22	775x1030x2100	730	230V - 50Hz	190	0,70	R404A	22	304	-
AIM PR70F4	-10 / -22	775x1030x2100	730	230V - 50Hz	190	0,70	R404A	22	430	-

 R290 İstenildiği takdirde fiyatlara %3 ilave edilir. / For R290 Refrigerant gas, price increase is 3%.

TEKNİK DETAYLAR / TECHNICAL DETAILS

TR

- Dış ortam sıcaklığı +43°C %65 nem oranı
- Eşit sıcaklık dağılımı için yeni tasarım
- Sıfır ODP enjekte 42 kg/m³ çevre dostu poliüretan izolasyon
- Kolay okunur ekranlı dijital kontrol
- Ergonomik kapı ve kulpu sayesinde kolay açılma ve temizlik
- Patentli 'Icecool' soğutma sistemi ile mükemmel verim ve enerji sarfiyatı
- Sıcak gaz defrost sistemi
- Atık ısı geri kazanımlı kondanzasyon
- 22 adet 60x80 tepsi kapasitesi

EN

- Designed to operate in 43°C ambient %65 humidity
- New design for equal temperature distribution
- Zero ODP Injected 42 kg/m³ Polyurethane Insulation
- Digital controller with easy read screen
- Ergonomic door and handle designed for ease of opening and cleaning
- Icecool refrigeration system designed to be most technologically advanced and energy efficient yet
- Hot gas defrost system
- Waste heat recovery condensate vaporiser system
- 22 no's of 60x80 tray capacity

AIM PR70

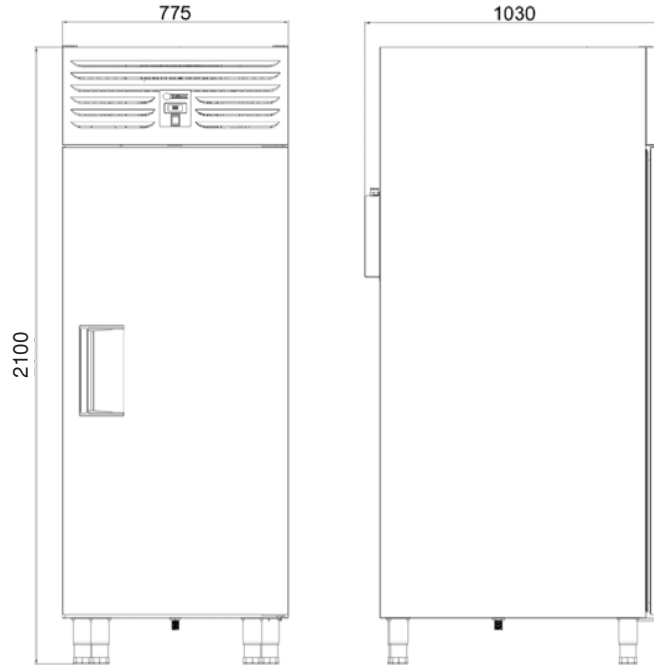

OPSIYONLAR / OPTIONS

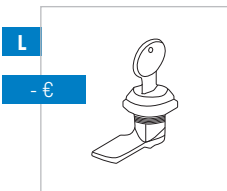

Dolap Kilidi / Cabinet Lock



Tekerlekli - Wheels

AIM

AIM PR14

DİK TİP PATİSERİ BUZDOLABI - 2 KAPILI
VERTICAL PATISSERIE REFRIGERATORS - W/2 DOORS

NEW PRODUCT



60x80 TEPSİ KAPASİTESİ
60x80 TRAY CAPACITY

KOD / CODE	°C	mm	lt	Power	kg	(KW)	R	KAPASİTE CAPACITY 60X80	PASLANMAZ TİPİ S.S. TYPE	€
AIM PR14R3	-2 / +8	1550x1030x2100	1460	230V - 50Hz	300	0,35	R134A	44	304	-
AIM PR14R4	-2 / +8	1550x1030x2100	1460	230V - 50Hz	300	0,35	R134A	44	430	-
AIM PR14F3	-10 / -22	1550x1030x2100	1460	230V - 50Hz	350	0,80	R404A	44	304	-
AIM PR14F4	-10 / -22	1550x1030x2100	1460	230V - 50Hz	350	0,80	R404A	44	430	-

R290 İstenildiği takdirde fiyatlara %3 ilave edilir. / For R290 Refrigerant gas, price increase is 3%.

TEKNİK DETAYLAR / TECHNICAL DETAILS

TR

- Dış ortam sıcaklığı +43°C %65 nem oranı
- Eşit sıcaklık dağılımı için yeni tasarım
- Sıfır ODP enjekte 42 kg/m³ çevre dostu poliüretan izolasyon
- Kolay okunur ekranlı dijital kontrol
- Ergonomik kapı ve kulpu sayesinde kolay açılma ve temizlik
- Patentli 'Icecool' soğutma sistemi ile mükemmel verim ve enerji sarfıyatı
- Sıcak gaz defrost sistemi
- Atık ısı geri kazanımlı kondanzasyon
- 44 adet 60x80 tepsi kapasitesi

EN

- Designed to operate in 43°C ambient %65 humidity
- New design for equal temperature distribution
- Zero ODP Injected 42 kg/m³ Polyurethane Insulation
- Digital controller with easy read screen
- Ergonomic door and handle designed for ease of opening and cleaning
- Icecool refrigeration system designed to be most technologically advanced and energy efficient yet
- Hot gas defrost system
- Waste heat recovery condensate vaporiser system
- 44 no's of 60x80 tray capacity

AIM PR14

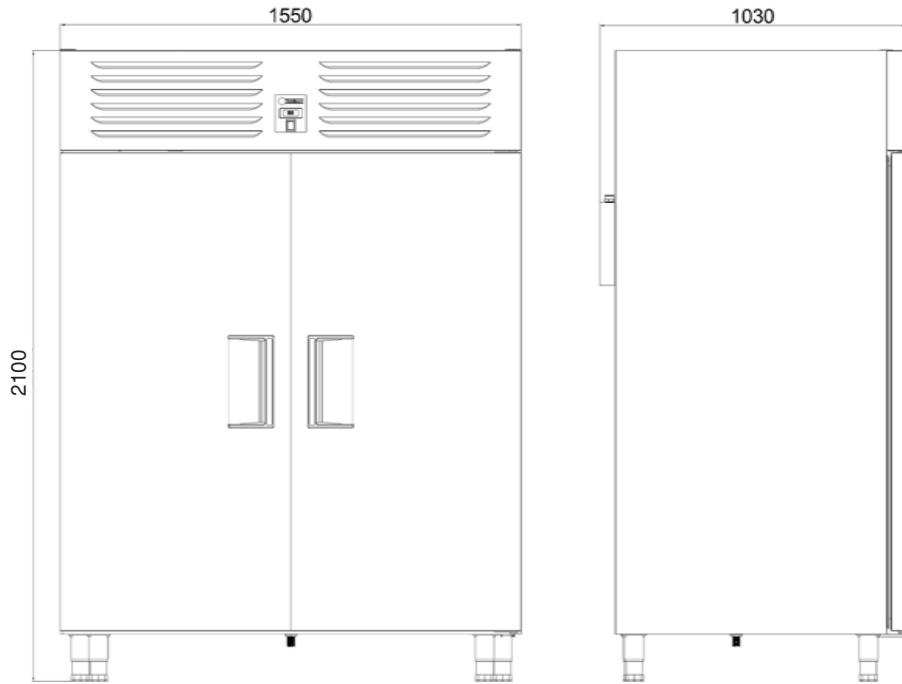

OPSIYONLAR / OPTIONS

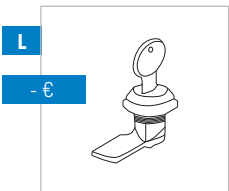

Dolap Kilidi / Cabinet Lock

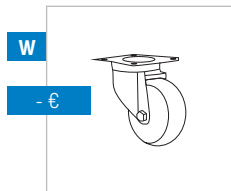

Tekerlekli - Wheels

AIM

AIM 208

TEZGAH TİP PATİSERİ BUZDOLABI - 3 KAPILI
COUNTER PATISSERIE REFRIGERATORS - W/3 DOOR

NEW PRODUCT

KOD / CODE	°C	(MM)	lt	Power	kg	(KW)	❄️	KAPASİTE CAPACITY 40X60	PASLANMAZ TİPİ S.S. TYPE	€
AIM 208R3	-2 / +8	2000x810x850	600	230V - 50Hz	137	0,34	R134A	22	304	-
AIM 208R4	-2 / +8	2000x810x850	600	230V - 50Hz	137	0,34	R134A	22	430	-
AIM 208F3	-10 / -22	2000x810x850	600	230V - 50Hz	137	0,75	R404A	22	304	-
AIM 208F4	-10 / -22	2000x810x850	600	230V - 50Hz	137	0,75	R404A	22	430	-

 R290 İstenildiği takdirde fiyatlara %3 ilave edilir. / For R290 Refrigerant gas, price increase is 3%.

TEKNİK DETAYLAR / TECHNICAL DETAILS

TR

- Dış ortam sıcaklığı +43°C %65 nem oranı
- Eşit sıcaklık dağılımı için yeni tasarım
- Sıfır ODP enjekte 42 kg/m³ çevre dostu poliüretan izolasyon
- Kolay okunur ekranlı dijital kontrol
- Ergonomik kapı ve kulpu sayesinde kolay açılma ve temizlik
- Patentli 'Icecool' soğutma sistemi ile mükemmel verim ve enerji sarfıyatı
- Sıcak gaz defrost sistemi
- Atık ısı geri kazanımlı kondanzasyon
- 22 adet 40x60 tepsi kapasitesi

EN

- Designed to operate in 43°C ambient %65 humidity
- New design for equal temperature distribution
- Zero ODP Injected 42 kg/m³ Polyurethane Insulation
- Digital controller with easy read screen
- Ergonomic door and handle designed for ease of opening and cleaning
- Icecool refrigeration system designed to be most technologically advanced and energy efficient yet
- Hot gas defrost system
- Waste heat recovery condensate vaporiser system
- 22 no's of 40x60 tray capacity

AIM 208

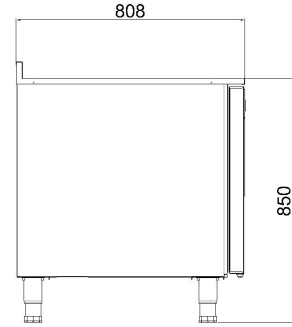
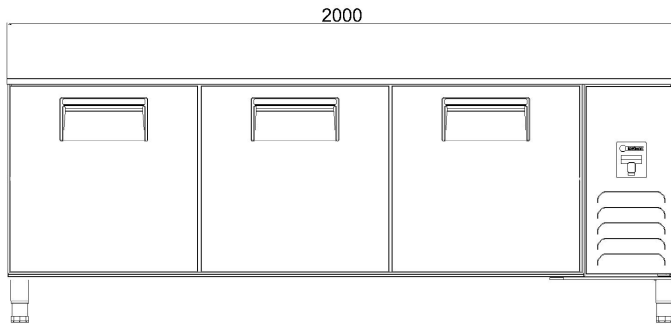

OPSIYONLAR / OPTIONS

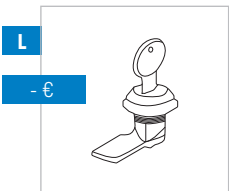

L
- €
Dolap Kiliti / Cabinet Lock



W
- €
Tekerlekli - Wheels

**AIM**

AIM CSF80 / CSF16

-30° PASTA ŞOKLAMA DOLABI
-30° CAKE BLAST FREEZER

NEW PRODUCT



KOD / CODE	°C	(MM)	lit	Power	kg	(KW)	R404A	KAPASİTE CAPACITY 60X80	PASLANMAZ TİPİ S.S. TYPE	€
AIM CSFS803	-10 / -30	900x1030x2100	800	230V - 50Hz	160	0,8	R404A	22	304	-
AIM CSFS804	-10 / -30	900x1030x2100	800	230V - 50Hz	160	0,8	R404A	22	430	-
AIM CSF163	-10 / -30	1800x1030x2100	1600	230V - 50Hz	190	1,1	R404A	44	304	-
AIM CSF164	-10 / -30	1800x1030x2100	1600	230V - 50Hz	190	1,1	R404A	44	430	-

 R290 İstenildiği takdirde fiyatlara %3 ilave edilir. / For R290 Refrigerant gas, price increase is 3%.

TEKNİK DETAYLAR / TECHNICAL DETAILS

TR

- Dış ortam sıcaklığı +43°C %65 nem oranı
- Eşit sıcaklık dağılımı için yeni tasarım
- Sıfır ODP enjekte 42 kg/m³ çevre dostu poliüretan izolasyon
- Kolay okunur ekranlı dijital kontrol
- Ergonomik kapı ve kulpu sayesinde kolay açılma ve temizlik
- Patentli 'Icecool' soğutma sistemi ile mükemmel verim ve enerji sarfiyatı
- Sıcak gaz defrost sistemi
- Atık ısı geri kazanımlı kondanzasyon
- 22 adet 60x80 tepsi kapasitesi

EN

- Designed to operate in 43°C ambient %65 humidity
- New design for equal temperature distribution
- Zero ODP Injected 42 kg/m³ Polyurethane Insulation
- Digital controller with easy read screen
- Ergonomic door and handle designed for ease of opening and cleaning
- Icecool refrigeration system designed to be most technologically advanced and energy efficient yet
- Hot gas defrost system
- Waste heat recovery condensate vaporiser system
- 22 no's of 60x80 tray capacity

AIM CSF80 / CSF16

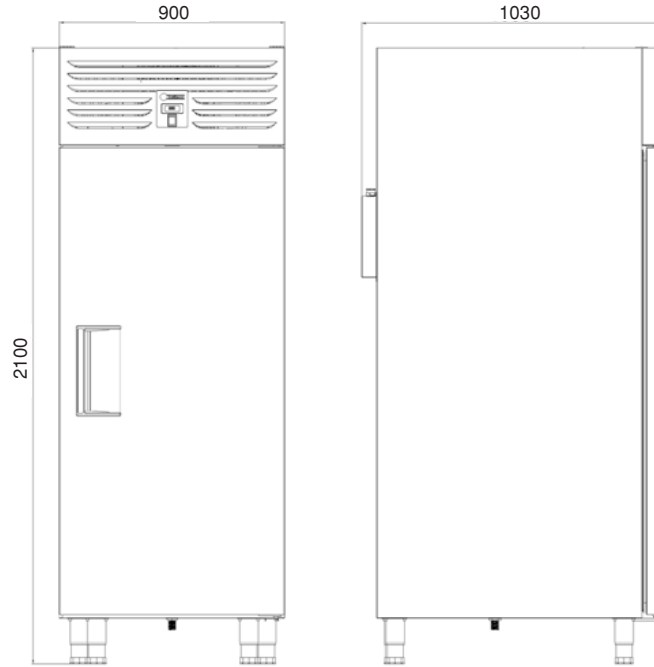

OPSIYONLAR / OPTIONS

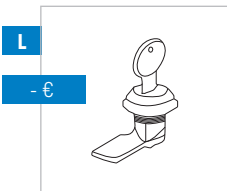

Dolap Kilidi / Cabinet Lock

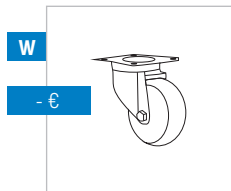

Tekerlekli - Wheels

AIM

AIM RP600

MAYALANDIRMA BUZDOLABI
RETARDER PROVER

NEW PRODUCT



KOD / CODE	°C	mm	lt	Power	kg	(kW)	R134A	KAPASİTE CAPACITY 40X60	PASLANMAZ TİPİ S.S. TYPE	€
AIM RP600	-18 / +45	775x1030x2100	668	230V - 50Hz	140	0,65	R134A	20	304	-

TEKNİK DETAYLAR / TECHNICAL DETAILS

TR

- Dış ortam sıcaklığı +43°C %65 nem oranı
- Eşit sıcaklık dağılımı için yeni tasarım
- Sıfır ODP enjekte 42 kg/m³ çevre dostu poliüretan izolasyon
- Kolay okunur ekranlı dijital kontrol
- Ergonomik kapı ve kulpu sayesinde kolay açılma ve temizlik
- Patentli 'Icecool' soğutma sistemi ile mükemmel verim ve enerji sarfiyatı
- Sıcak gaz defrost sistemi
- Atık ısı geri kazanımlı kondanzasyon
- İç ısı dağılım dengesini sağlayan hava yönlendirme sistemi
- İleri tarihli, gerçek zaman ayarlı otomatik fermantasyon sistemi
- 20 adet 40x60 tepsi kapasitesi

EN

- Designed to operate in 43°C ambient %65 humidity
- New design for equal temperature distribution
- Zero ODP Injected 42 kg/m³ Polyurethane Insulation
- Digital controller with easy read screen
- Ergonomic door and handle designed for ease of opening and cleaning
- Icecool refrigeration system designed to be most technologically advanced and energy efficient yet
- Hot gas defrost system
- Waste heat recovery condensate vaporiser system
- Air managing system which provides inside refrigeration balance
- Forthcoming real-time automated fermentation system.
- 20 no's of 40x60 tray capacity

AIM RP600

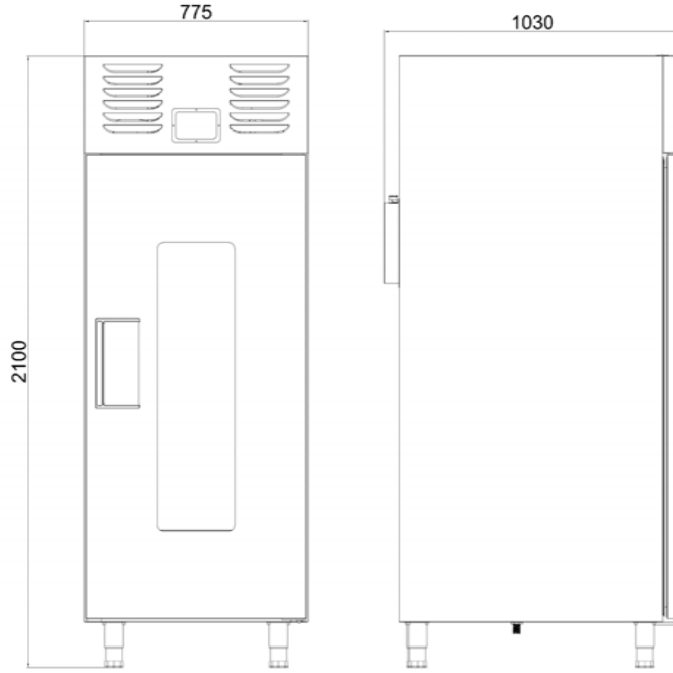

OPSIYONLAR / OPTIONS

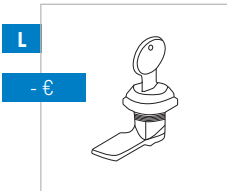

Dolap Kilidi / Cabinet Lock

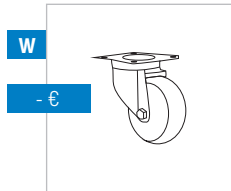

Tekerlekli - Wheels

BUZ
MAKİNE FİRİ



ICE CUBE
MACHINE



AIM

AIM 20-30-50

BUZ MAKİNASI
ICE CUBE MACHINE**NEW PRODUCT****AIM20****AIM30****AIM50****20KG/GÜN**
20KG/DAY**30KG/GÜN**
30KG/DAY**50KG/GÜN**
50KG/DAY

KOD / CODE	AIM 20	AIM 30	AIM 50
Günlük Buz Yapma Kapasitesi / Ice Making Capacity Per Day	20 kg	30 kg	45 kg
Soğutma Sistemi / Cooling System	Hava (Air Cooled)	Hava (Air Cooled)	Hava (Air Cooled)
Maksimum Güç / Maximum Power	540 W	540 W	620 W
İklim Sınıfı / Tropical Class	T	T	T
Ürün Ölçüleri / Product Dimensions (mm)	306 x 512 x 660	390 x 600 x 730	473 x 600 x 820
Ambalaj Ölçüleri / Packing Dimensions (mm)	360 x 565 x 970	440 x 650 x 1000	530 x 650 x 1100
Ürün Ağırlığı / Product Weight	40 kg	48 kg	56 kg
Fiyat / Price	- €	- €	- €

 R290 İstenildiği takdirde fiyatlara %3 ilave edilir. / For R290 Refrigerant gas, price increase is 3%.

TEKNİK DETAYLAR / TECHNICAL DETAILS

TR

- Tropikal iklim sınıfı +43 °C
- Temizlik gerektirmeyen kondenser
- Sıfır ODP enjekte 42 kg/ m³ çevre dostu poliüretan izolasyon
- Antibakteriyel buz saklama alanı
- Manyetik pompa ile sessiz çalışma
- Elektronik kontrol
- Geniş buz depolama alanı
- Ergonomik kapak kulbu
- Patentli nozul sistemi ile daha kısa süreli buz döngüsü

EN

- Tropical class +43 °C
- Stay clear condenser
- Zero ODP injected 42 kg/ m³ polyurathane insulation
- Antibacterial storage area
- Silent operation with magnetic pump
- Electronic control
- Large ice storage bin
- Ergonomic door handle
- Patented nozzle system provides less cycles

AIM 20-30-50

AIM20

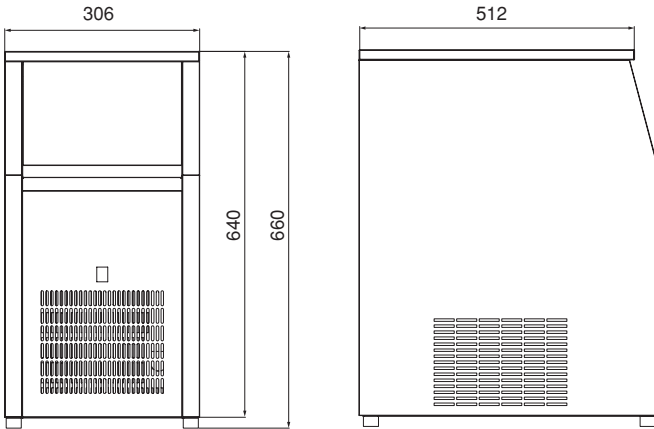

AIM30

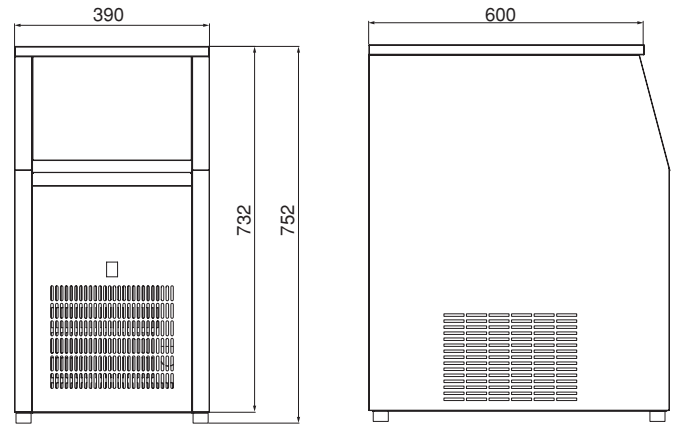

AIM50

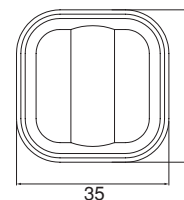
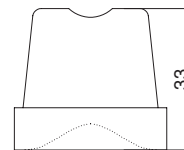
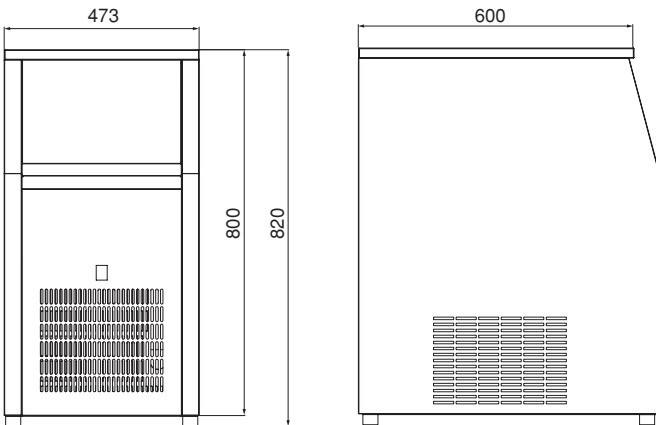

22gr

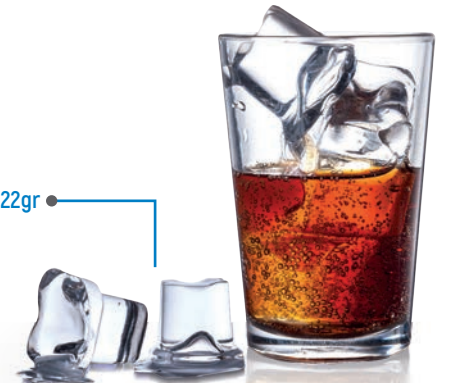

AIM

AIM 90-130

BUZ MAKİNASI
ICE CUBE MACHINE**NEW PRODUCT****AIM90****90KG/GÜN**
90KG/DAY**AIM130****130KG/GÜN**
130KG/DAY

KOD / CODE	AIM 90	AIM 130
Günlük Buz Yapma Kapasitesi / Ice Making Capacity Per Day	85 kg	130 kg
Soğutma Sistemi / Cooling System	Hava (Air Cooled)	Hava (Air Cooled)
Maksimum Güç / Maximum Power	910 W	1200 W
İklim Sınıfı / Tropical Class	T	T
Ürün Ölçüleri / Product Dimensions (mm)	610 x 600 x 820	730 x 750 x 900
Ambalaj Ölçüleri / Packing Dimensions (mm)	660 x 650 x 1100	780 x 800 x 950
Ürün Ağırlığı / Product Weight	82 kg	110 kg
Fiyat / Price	- €	- €

 R290 İstenildiği takdirde fiyatlara %3 ilave edilir. / For R290 Refrigerant gas, price increase is 3%.

TEKNİK DETAYLAR / TECHNICAL DETAILS

TR

- Tropikal iklim sınıfı +43 °C
- Temizlik gerektirmeyen kondenser
- Sıfır ODP enjekte 42 kg/ m³ çevre dostu poliüretan izolasyon
- Antibakteriyel buz saklama alanı
- Manyetik pompa ile sessiz çalışma
- Elektronik kontrol
- Geniş buz depolama alanı
- Ergonomik kapak kulbu
- Patentli nozul sistemi ile daha kısa süreli buz döngüsü

EN

- Tropical class +43 °C
- Stay clear condenser
- Zero ODP injected 42 kg/ m³ polyurathane insulation
- Antibacterial storage area
- Silent operation with magnetic pump
- Electronic control
- Large ice storage bin
- Ergonomic door handle
- Patented nozzle system provides less cycles

AIM 90-130

AIM90

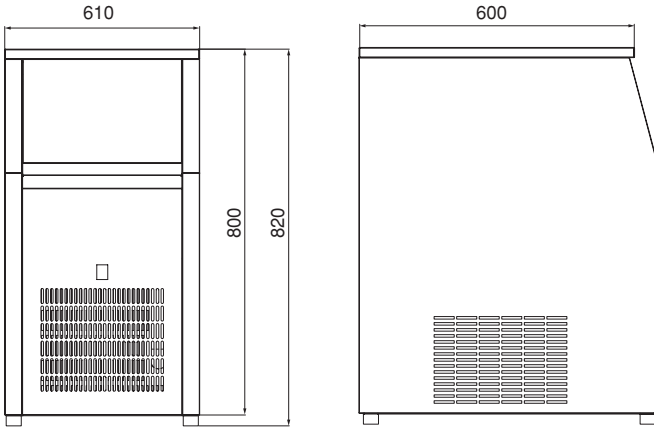

AIM130

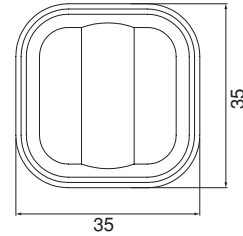
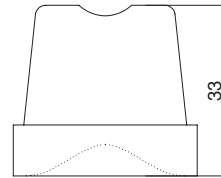
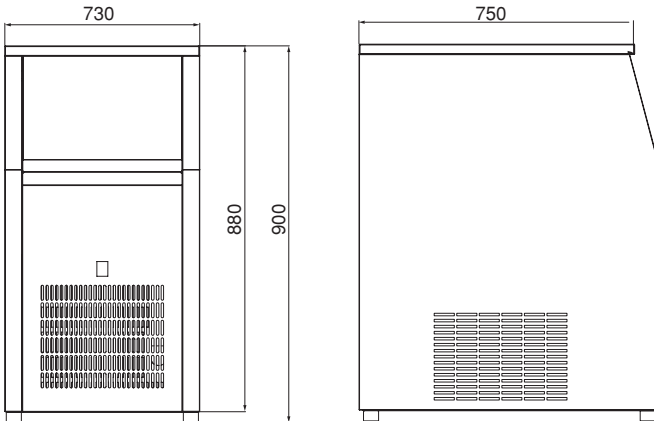

22gr



AIM

AIM 250-500

BUZ MAKİNASI
ICE CUBE MACHINE

NEW PRODUCT

500KG/GÜN
500KG/DAY

AIM500

250KG/GÜN
250KG/DAY

AIM250

180 KG KAPASİTE
180 KG CAPACITY

BN200

220 KG KAPASİTE
220 KG CAPACITY

BN400

KOD / CODE	BUZ MAKİNELERİ / ICE MAKERS		HAZNELER / ICE BINS	
	AIM 250	AIM 400	BN 200	BN 400
Günlük Buz Yapma Kapasitesi / Ice Making Capacity Per Day	250 kg	400 kg	180 kg	220 kg
Soğutma Sistemi / Cooling System	Hava (Air Cooled)	Hava (Air Cooled)	-	-
Maksimum Güç / Maximum Power	1100 W	2440 W	-	-
İklim Sınıfı / Tropical Class	T	T	-	-
Ürün Ölçüleri / Product Dimensions (mm)	820 x 720 x 600	820 x 720 x 830	820 x 770 x 1040	820 x 770 x 1200
Ambalaj Ölçüleri / Packing Dimensions (mm)	870 x 770 x 750	870 x 770 x 980	880 x 810 x 1200	880 x 810 x 1350
Ürün Ağırlığı / Product Weight	86 kg	117 kg	55 kg	63 kg
Fiyat / Price	- €	- €	- €	- €

 R290 İstenildiği takdirde fiyatlara %3 ilave edilir. / For R290 Refrigerant gas, price increase is 3%.

TEKNİK DETAYLAR / TECHNICAL DETAILS

TR

- Tropikal iklim sınıfı +43 °C
- Temizlik gerektirmeyen kondenser
- Sıfır ODP enjekte 42 kg/ m³ çevre dostu poliüretan izolasyon
- Antibakteriyel buz saklama alanı
- Manyetik pompa ile sessiz çalışma
- Elektronik kontrol
- Geniş buz depolama alanı
- Ergonomik kapak kulbu
- Patentli nozul sistemi ile daha kısa süreli buz döngüsü

EN

- Tropical class +43 °C
- Stay clear condenser
- Zero ODP injected 42 kg/ m³ polyurathane insulation
- Antibacterial storage area
- Silent operation with magnetic pump
- Electronic control
- Large ice storage bin
- Ergonomic door handle
- Patented nozzle system provides less cycles

AIM 250-500

AIM250

BN200

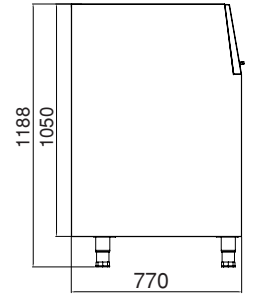
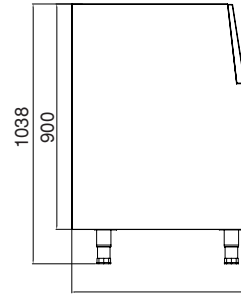
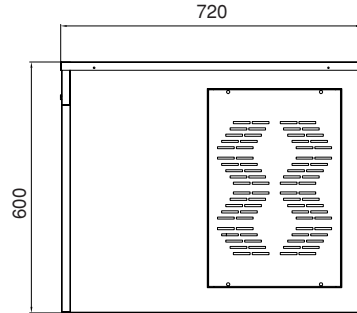
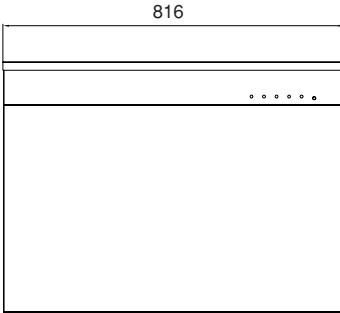

AIM500

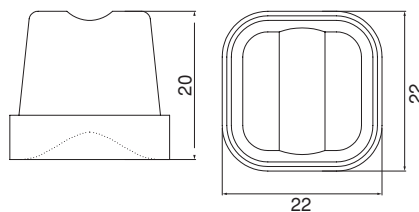
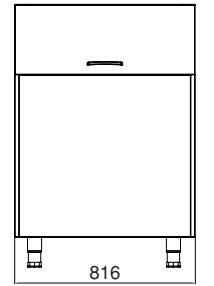
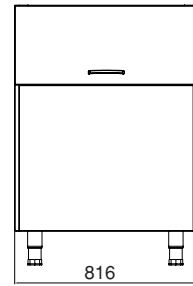
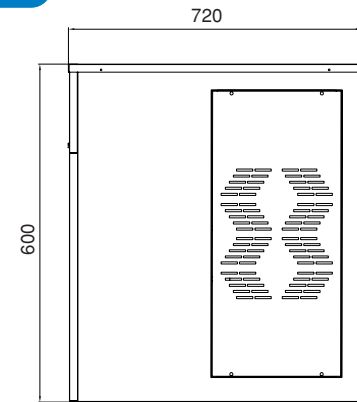
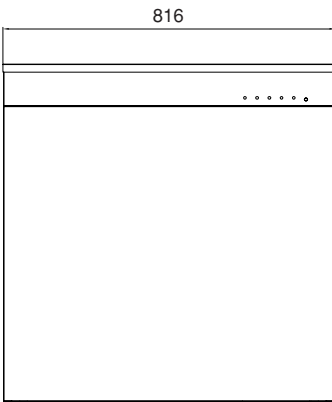

10gr



YIKAMA EKİPMANLARI



DISHWASHER EQUIPMENT

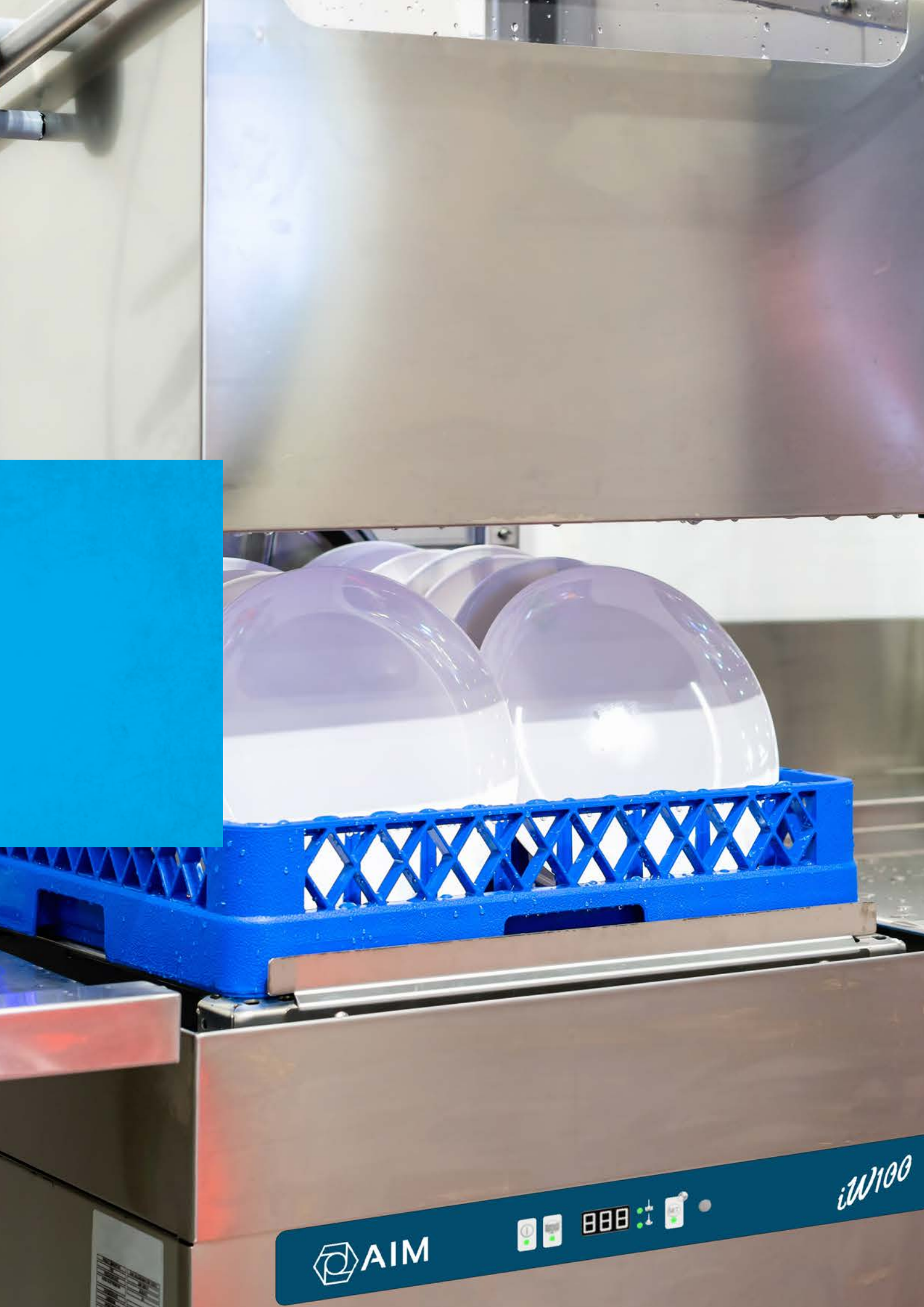

 AIM

  888  

iW100

AIM



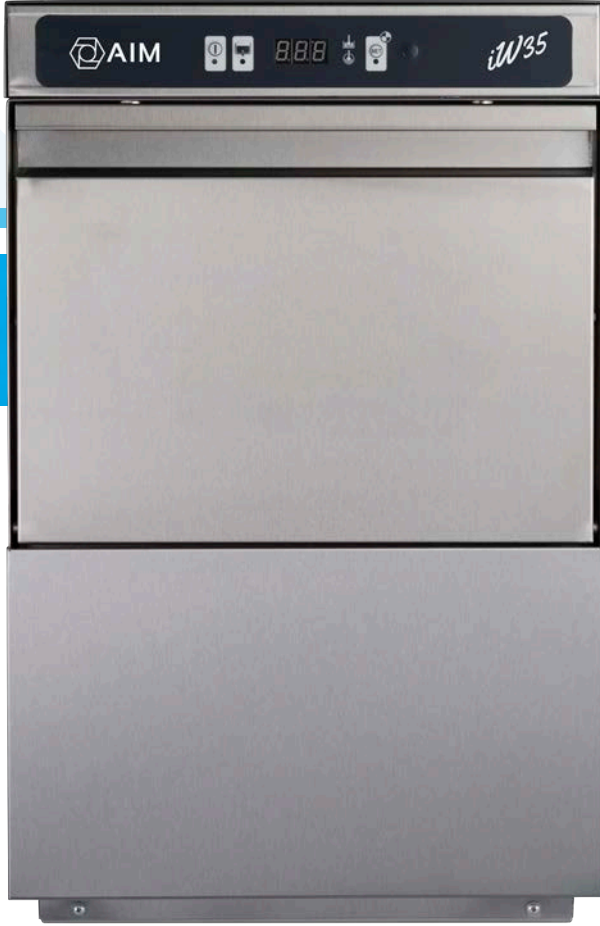

AIM IW35

BARDAK YIKAMA MAKİNASI - 35x35 BASKET
GLASSWASHER - 35x35 BASKET

NEW PRODUCT



KOD / CODE	DRENAJ POMPASI DRAIN PUMP	PARLATICI POMPASI RINSE-AID PUMP	DETERJAN POMPASI DETERGENT PUMP
IW35-P	✓	✓	-
IW35	✓	-	-

ÜRÜN ADI / PRODUCT NAME	KOD / CODE	 [MM]	 KAPASİTE CAPACITY [Bardak/Saat - Glass/Hour]		 Kg	€
Bardak Yikama Makinesi Glasswasher	IW35-P	435x492x687	350	230V - 50Hz	48	-
Bardak Yikama Makinesi Glasswasher	IW35	435x492x687	350	230V - 50Hz	48	-

TEKNİK DETAYLAR / TECHNICAL DETAILS

TR

- Dijital kontrol ile kullanım kolaylığı
- 120sn - 150sn - 180sn üç ayrı yıkama programı
- 50° Yıkama suyu sıcaklığı
- 75° Durulama suyu sıcaklığı
- 3/4 İnç su giriş bağlantısı
- 15Lt Yıkama tankı kapasitesi
- 4Lt Boyler tankı kapasitesi
- 3Lt Su tüketimi
- 1,5 Kw Yıkama rezistans gücü
- 2,2 Kw Boyler rezistans gücü
- 3 Kw Max. Makina gücü

EN

- Easy Operation with Digital Control.
- 120 sec. , 150 sec. , 180 sec. 3 different washing programme.
- 50° Boiler Temperature
- 75° Washing Tank Temperature
- 3/4 Inch water inlet connection
- 15Lt Water Tank Capacity
- 4Lt Boiler Tank Capacity
- 3Lt water Consumption
- 1,5 Kw Tank heater power.
- 2,2 Kw Boiler heater power.
- 3 Kw Max. Total power.

AIM IW35

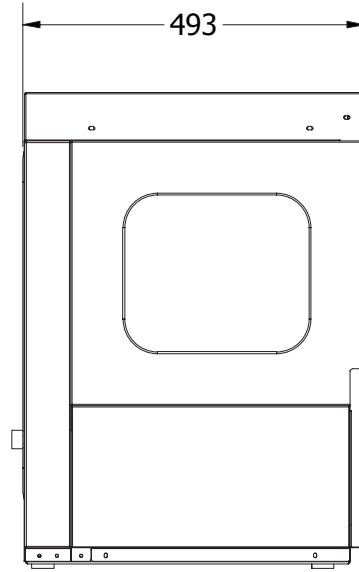
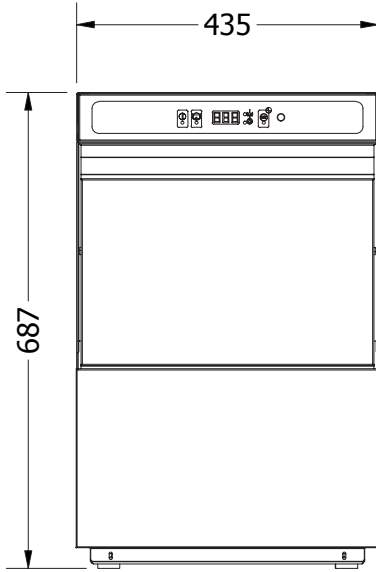

DİJİTAL PANELE DETAYLARI / DIGITAL PANNEL DETAILS

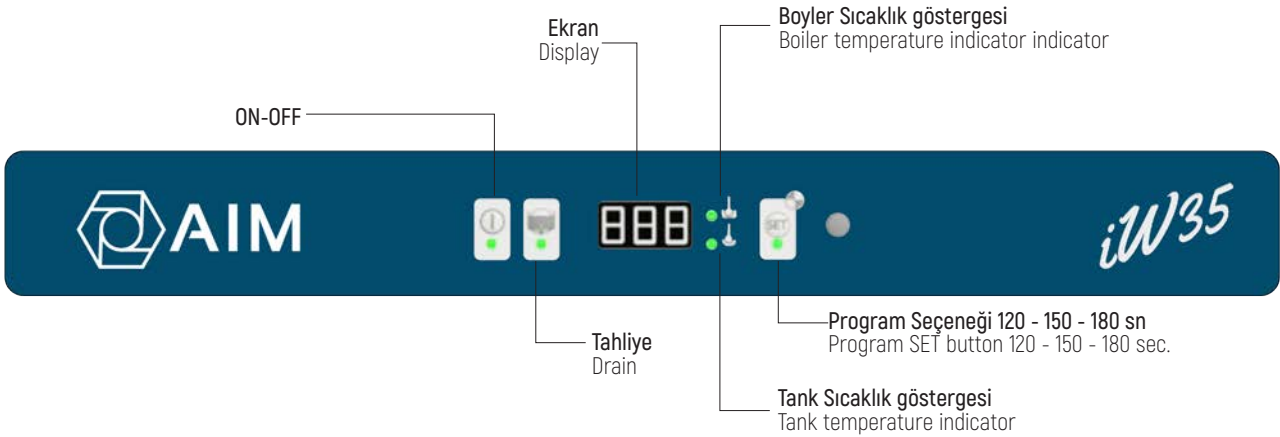





AIM

AIM IW40

BARDAK YIKAMA MAKİNASI - 40x40 BASKET
GLASSWASHER - 40x40 BASKET



KOD / CODE	DRENAJ POMPASI DRAIN PUMP	PARLATICI POMPASI RINSE-AID PUMP	DETERJAN POMPASI DETERGENT PUMP
IW40-P	✓	✓	✓
IW40	✓		

ÜRÜN ADI / PRODUCT NAME	KOD / CODE	 [MM]	 KAPASİTE CAPACITY [Bardak/Saat - Glass/Hour]	 KAPASİTE CAPACITY [Tabak/Saat - Plate/Hour]		 Kg	€
Bardak Yıkama Makinesi Glasswasher	IW40-P	485x520x760	1000	400	230V - 50Hz	48	-
Bardak Yıkama Makinesi Glasswasher	IW40	485x520x760	1000	400	230V - 50Hz	48	-

TEKNİK DETAYLAR / TECHNICAL DETAILS

TR

- Dijital kontrol ile kullanım kolaylığı
- 90sn - 120sn - 180sn üç ayrı yıkama programı
- 50° Yıkama suyu sıcaklığı
- 82° Durulama suyu sıcaklığı
- 3/4 İnç su giriş bağlantısı
- 18Lt Yıkama tankı kapasitesi
- 5Lt Boyler tankı kapasitesi
- 3Lt Su tüketimi
- 1,8Kw Yıkama rezistans gücü
- 2,2Kw Boyler rezistans gücü
- 2,5Kw Max. Makina gücü

EN

- Easy Operation with Digital Control.
- 90 sec. , 120 sec. , 180 sec. 3 different washing programme.
- 50° Boiler Temperature
- 82° Washing Tank Temperature
- 3/4 Inch water inlet connection
- 18 Lt Water Tank Capacity
- 5 Lt Boiler Tank Capacity
- 3 Lt water Consumption
- 1,8 Kw Tank heater power.
- 2,2 Kw Boiler heater power.
- 2,5 Kw Max. Total power.

AIM IW40

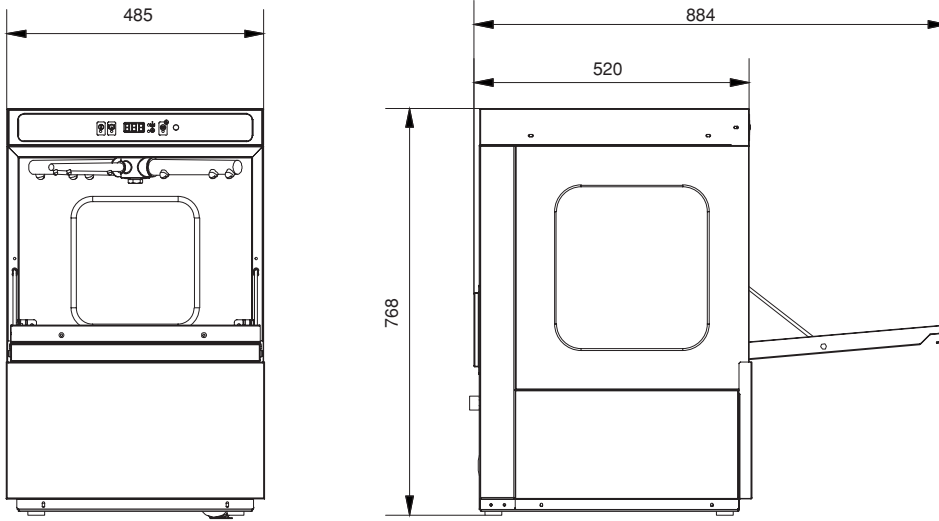

DİJİTAL PANELE DETAYLARI / DIGITAL PANNEL DETAILS

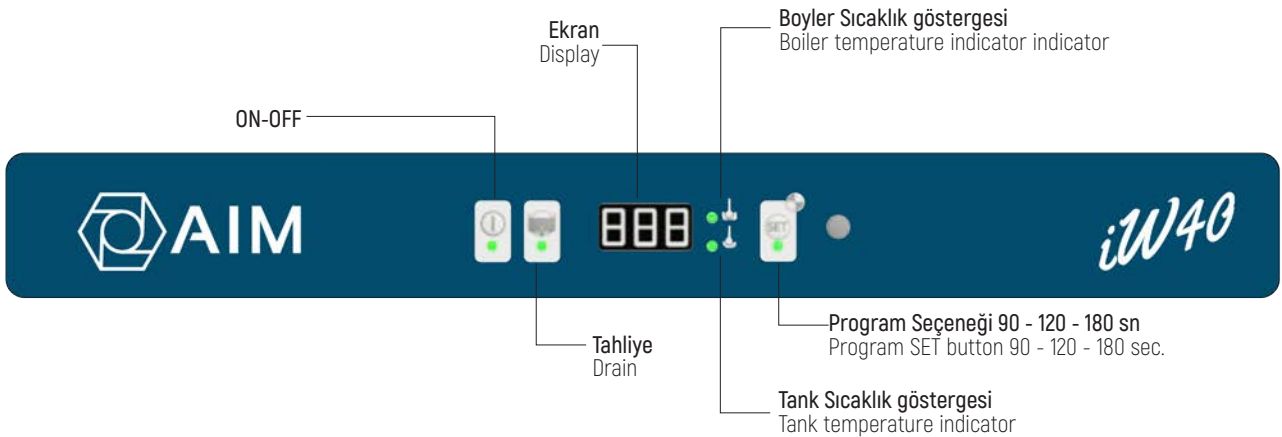





AIM

AIM IW50

SET ALTI BULAŞIK YIKAMA MAKİNASI - 50x50 BASKET
UNDERCOUNTER DISWASHER - 50x50 BASKET



KOD / CODE	DRENAJ POMPASI DRAIN PUMP	PARLATICI POMPASI RINSE-AID PUMP	DETERJAN POMPASI DETERGENT PUMP
IW50-P	✓	✓	✓
IW50	✓		

ÜRÜN ADI / PRODUCT NAME	KOD / CODE	 (MM)	 KAPASİTE CAPACITY [Tabak/Saat - Plate/Hour]			€
Set Altı Bulaşık Yıkama Makinesi Undercounter Diswasher	IW50-P	600x628x825	500	230V - 50Hz	67	-
Set Altı Bulaşık Yıkama Makinesi Undercounter Diswasher	IW50	600x628x825	500	230V - 50Hz	65	-

TEKNİK DETAYLAR / TECHNICAL DETAILS

TR

- Dijital kontrol ile kullanım kolaylığı
- 90sn - 120sn - 180sn üç ayrı yıkama programı
- 55° Yıkama suyu sıcaklığı
- 82° Durulama suyu sıcaklığı
- 3/4 İnç su giriş bağlantısı
- 33Lt Yıkama tankı kapasitesi
- 6Lt Boyler tankı kapasitesi
- 3 Lt Su tüketimi
- 2 Kw Yıkama rezistans gücü
- 2,2 Kw Boyler rezistans gücü
- 5,20 Kw Max. Makina gücü

EN

- Easy Operation with Digital Control.
- 90 sec. , 120 sec. , 180 sec. 3 different washing programme.
- 55° Boiler Temperature
- 82° Washing Tank Temperature
- 3/4 Inch water inlet connection
- 18 Lt Water Tank Capacity
- 5 Lt Boiler Tank Capacity
- 3 Lt water Consumption
- 2 Kw Tank heater power.
- 2,2 Kw Boiler heater power.
- 5,20 Kw Max. Total power.

AIM IW50

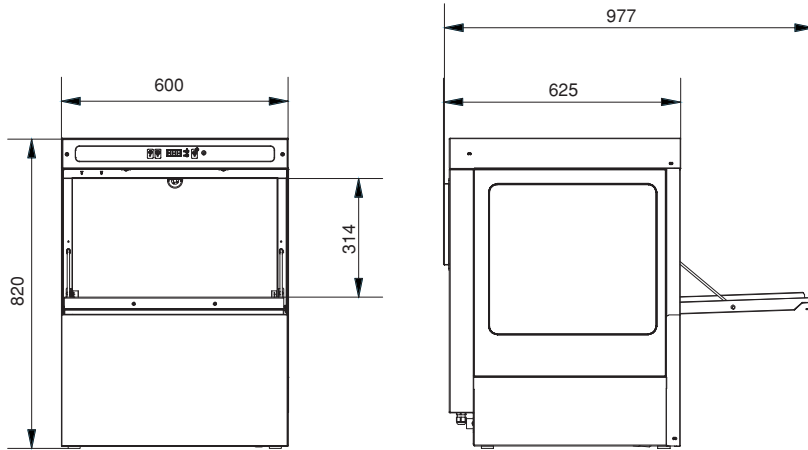

DİJİTAL PANEL DETAYLARI / DIGITAL PANNEL DETAILS

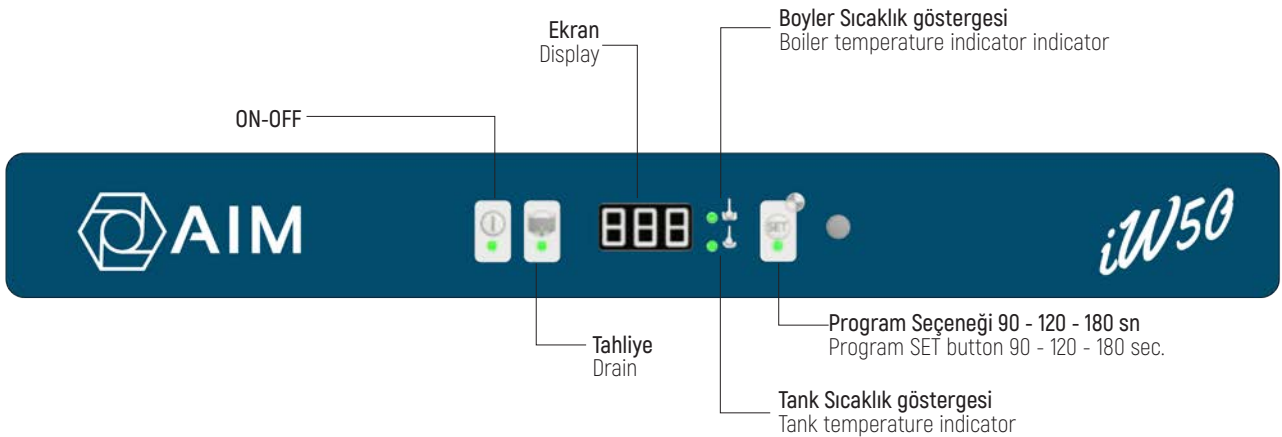





AIM

AIM IW100

GİYOTİN TİP BULAŞIK YIKAMA MAKİNESİ - 50x50 BASKET
HOOD TYPE DISHWASHER - 50x50 BASKET



KOD / CODE	DRENAJ POMPASI DRAIN PUMP	PARLATICI POMPASI RINSE-AID PUMP	DETERJAN POMPASI DETERGENT PUMP
IW100-P		✓	✓
IW100			

ÜRÜN ADI / PRODUCT NAME	KOD / CODE	 [MM]	 KAPASİTE CAPACITY [Bardak/Saat - Glass/Hour]	 KAPASİTE CAPACITY [Tabak/Saat - Plate/Hour]		 kg	€
Giyotin Tip Bulaşık Yıkama Makinesi Hood Type Dishwasher	IW100-P	690x787x1475	1000	1000	400V / 3N / 50Hz	90	-
Giyotin Tip Bulaşık Yıkama Makinesi Hood Type Dishwasher	IW100	690x787x1475	1000	1000	400V / 3N / 50Hz	65	-

TEKNİK DETAYLAR / TECHNICAL DETAILS

TR

- Dijital kontrol ile kullanım kolaylığı
- 60sn - 90sn - 180sn üç ayrı yıkama programı
- 55° Yıkama suyu sıcaklığı
- 82° Durulama suyu sıcaklığı
- 3/4 İnç su giriş bağlantısı
- 70-37 Lt Yıkama tankı kapasitesi
- 8-12 Lt Boyler tankı kapasitesi
- 3 Lt Su tüketimi
- 3 Kw Yıkama rezistans gücü
- 9 Kw Boyler rezistans gücü
- 9,7 Kw Max. Makina gücü

EN

- Easy Operation with Digital Control.
- 60 sec. , 90 sec. , 180 sec. 3 different washing programme.
- 55° Boiler Temperature
- 82° Washing Tank Temperature
- 3/4 Inch water inlet connection
- 70-37 Lt Water Tank Capacity
- 8-12 Lt Boiler Tank Capacity
- 3 Lt water Consumption
- 3 Kw Tank heater power.
- 9 Kw Boiler heater power.
- 9,7 Kw Max. Total power.

AIM IW100

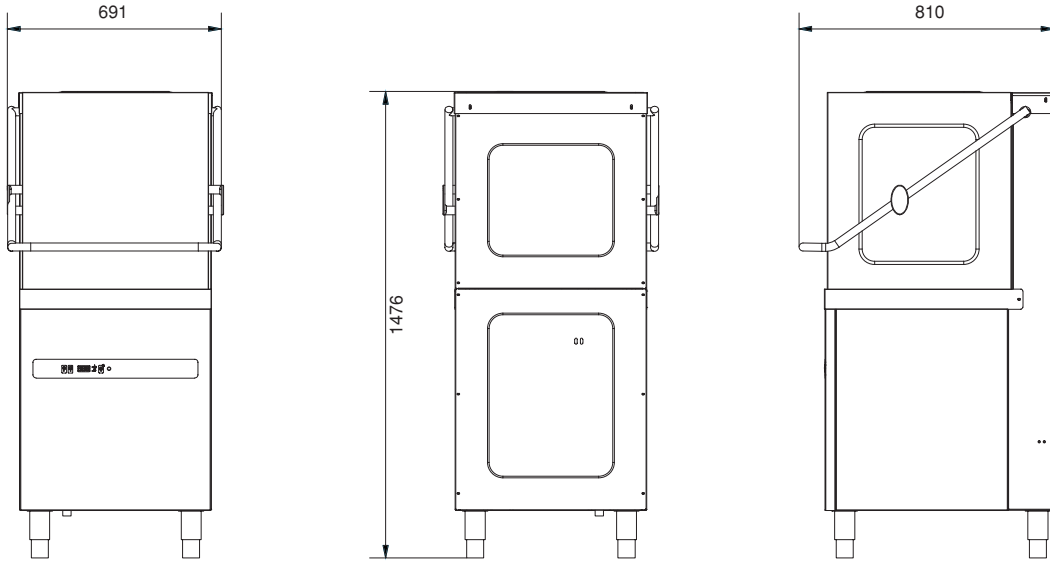

DİJİTAL PANEL DETAYLARI / DIGITAL PANNEL DETAILS

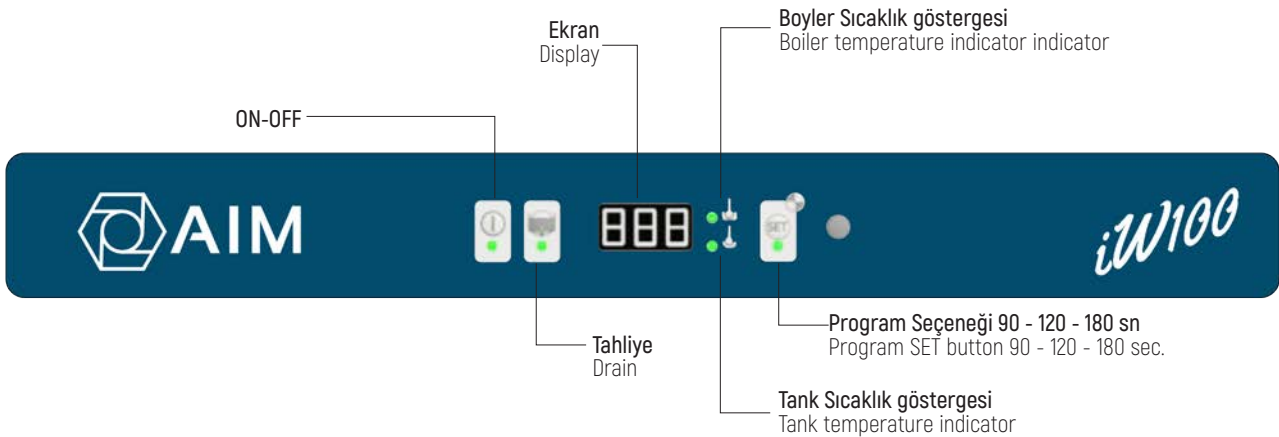

AIM

GİRİŞ/ÇIKIŞ TEZGAHLARI INLET / OUTLET TABLES



BYM ÇIKIŞ TEZGAHI

EXIT TABLE FOR DISHWASHER - FLAT PACKED

ÜRÜN ADI / PRODUCT NAME	KOD / CODE		(MM)	€
BYM Çıkış Tezgahı -Taban Rafılı Dishwasher Outlet Table-W/Undershelf	AIM-807585-L	AIM-807585-R	800x750x850	-
BYM Çıkış Tezgahı -Taban Rafılı Dishwasher Outlet Table-W/Undershelf	AIM-1207585-L	AIM-1207585-R	1200x750x850	-
BYM Çıkış Tezgahı -Taban Rafılı Dishwasher Outlet Table-W/Undershelf	AIM-1407585-L	AIM-1407585-R	1400x750x850	-



BYM GİRİŞ TEZGAHI

INLET TABLE FOR DISHWASHER - FLAT PACKED

ÜRÜN ADI / PRODUCT NAME	KOD / CODE		(MM)		€
BYM Çıkış Tezgahı Dishwasher Outlet Table	AIM-1207585-1L	AIM-1207585-1R	750x750x850	<input type="checkbox"/>	-
BYM Çıkış Tezgahı Dishwasher Outlet Table	AIM-1407585-1L	AIM-1407585-1R	1200x750x850	<input type="checkbox"/>	-
BYM Çıkış Tezgahı Dishwasher Outlet Table	AIM-1607585-2L	AIM-1607585-2R	1400x750x850	<input type="checkbox"/>	-

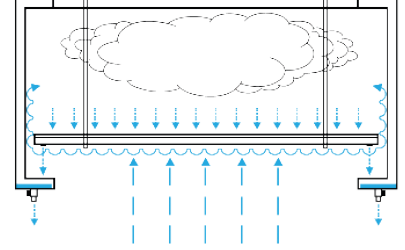

BYM DAVLUMBAZ CONDENSATION HOOD

ÜRÜN ADI / PRODUCT NAME	KOD / CODE	 (MM)	€
BYM Davlumbaz - Condensation Hood	AIM-10010040-CON	1000x1000x400	-
BYM Davlumbaz - Condensation Hood	AIM-15015040-CON	1500x1500x400	-

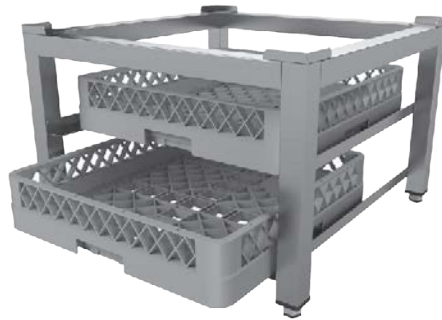



BASKET RAFI BASE FOR DISHWASHER

ÜRÜN ADI / PRODUCT NAME	KOD / CODE	 (MM)	€
Basket Rafı - Base For Dishwasher	AIM-60-DWS	610x610x400	-

AIM

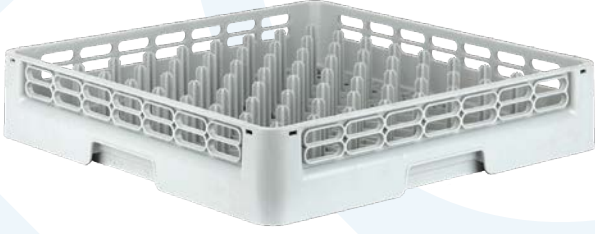
BULAŞIK MAKİNESİ SEPETLERİ DISHWASHER BASKETS



ÜRÜN ADI / PRODUCT NAME	KOD / CODE	 [MM]	€
Tabak Sepeti / Plate Basket	AIM-5050PT	500x500	-

ÜRÜN ADI / PRODUCT NAME	KOD / CODE	 [MM]	€
Çatal Kaşık Sepeti / Cutlery Basket	AIM-5050CT	500x500	-



ÜRÜN ADI / PRODUCT NAME	KOD / CODE	 [MM]	€
Bardak Sepeti / Glass Basket	AIM-5050GS	500x500	-

ÜRÜN ADI / PRODUCT NAME	KOD / CODE	 [MM]	€
Bardak Sepeti / Glass Basket	AIM-4040GS	400x400	-

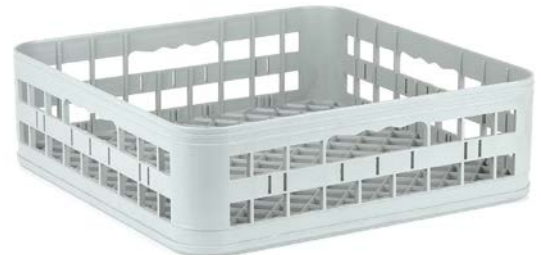

YIKAMA AKSESUARLARI WASHING ACCESSORIES



ÜRÜN ADI / PRODUCT NAME	KOD / CODE		€
Geri Toplamalı Yıkama Hortumu / Hose Reel	AIM-12HR	12	-



ÜRÜN ADI / PRODUCT NAME	KOD / CODE		€
20 Lt Sıvı Parlatici/ 20 Lt Liquid Rinse	AIM-RINSE20	32	-

ÜRÜN ADI / PRODUCT NAME	KOD / CODE		€
20 Lt Sıvı Deterjan/ 20 Lt Liquid Detergent	AIM-DET20	32	-



AIM

ÖN YIKAMA DUŞ SETLERİ PRE-RINSE SETS

TEZGAHA MONTE
COUNTER MOUNTED

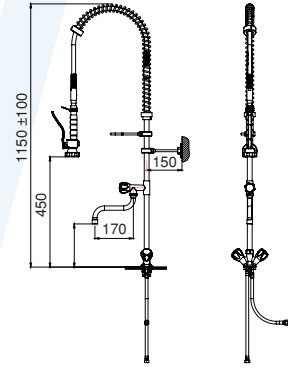
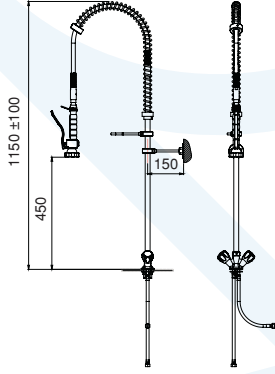

ÜRÜN ADI / PRODUCT NAME	KOD / CODE	€
Ön Yıkama Duş Ünitesi / Pre-Rinse Faucet	AIM-CTPR01	-

ÜRÜN ADI / PRODUCT NAME	KOD / CODE	€
Ön Yıkama Duş Ünitesi-Ara Musluklu / Pre-Rinse Faucet W/Internal Tap	AIM-CTPR02	-

DUVARA MONTE
WALL MOUNTED

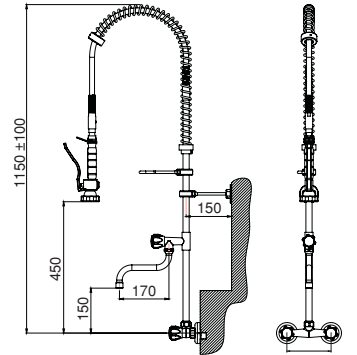
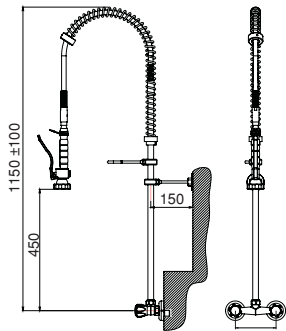

ÜRÜN ADI / PRODUCT NAME	KOD / CODE	€
Ön Yıkama Duş Ünitesi / Pre-Rinse Faucet	AIM-WPR01	-

ÜRÜN ADI / PRODUCT NAME	KOD / CODE	€
Ön Yıkama Duş Ünitesi / Pre-Rinse Faucet	AIM-WPR02	-

ÖN YIKAMA DUŞ SETLERİ PRE-RINSE SETS

TEZGAHA MONTE
COUNTER MOUNTED

NEW PRODUCT



ÜRÜN ADI / PRODUCT NAME	KOD / CODE	(MM)	€
Duşlama Ünitesi / Washer Unit	AIM-4023-D	400x230	-

ÜRÜN ADI / PRODUCT NAME	KOD / CODE	(MM)	€
Duşlama Ünitesi / Washer Unit	AIM-2023-D	200x230	-



ÜRÜN ADI / PRODUCT NAME	KOD / CODE	(MM)	€
Duşlama Ünitesi / Washer Unit	AIM-G01-1	Ø100	-

ÜRÜN ADI / PRODUCT NAME	KOD / CODE	(MM)	€
Duşlama Ünitesi / Washer Unit	AIM-G01-2	381x178x22	-



ÜRÜN ADI / PRODUCT NAME	KOD / CODE	(MM)	€
Duşlama Ünitesi / Washer Unit	AIM-G02	Ø100	-

**BÜTÜN TESİSAT GRUBU
FİYATA DAHİLDİR.**

ALL WATER CONNECTION
GROUP IS INCLUDED IN THE
PRICE.



FAST FOOD EKİPMANLARI



FAST FOOD EQUIPMENT







WFL21S



WFL22S



WFL23S



WFL24S



WFL25S



WFL26S





TEKNİK DETAYLAR / TECHNICAL DETAILS

TR

- Mekanik zamanlayıcı seçeneği
- Kolay değiştirilebilir teflon pişirme kalıpları
- Paslanmaz çelik gömülü ısıtıcılar ile hassas sıcaklık kontrolü
- Farklı sıcaklık ayarında çalıştırma
- Seri pişirmelerde yüksek performans
- Gösterge ve sinyal lambaları
- Paslanmaz çelik alt gövde
- Gıda ile temasa uygun pişirme kalıpları ve gövde
- **Teflon kaplı yapışmaz pişirme yüzeyi ve üst gövde**
- **Farklı şekillerde değiştirilebilir pişirme kalıpları**

EN

- Mechanic timer model options
- Different shaped baking plates feature
- Stainless steel embedded heating element for precise temperature control
- Operation with desired heating temperature
- High performance during dynamic operation
- Power ON and Ready-to-Bake LED indicators
- Stainless steel frame body
- Baking plates and body suitable for food contact
- **Teflon coated Non-Stick baking plate and top body**
- **Easy to change teflon coated baking plates**

KOD / CODE	 (MM)		 kg	 (KW)	€
AIM WFL21S	270x450x270	230V - 50-60Hz	13	2,5	-
AIM WFL22S	270x450x270	230V - 50-60Hz	13	2,5	-
AIM WFL23S	270x450x270	230V - 50-60Hz	13	2,5	-
AIM WFL24S	270x450x270	230V - 50-60Hz	13	2,5	-
AIM WFL25S	270x450x270	230V - 50-60Hz	13	2,5	-
AIM WFL26S	270x450x270	230V - 50-60Hz	13	2,5	-

WAFFLE MAKINELERİ - YUVARLAK WAFFLE MAKERS - ROUND



WFL21R



WFL22R



WFL23R



WFL24R





TEKNİK DETAYLAR / TECHNICAL DETAILS

TR

- Mekanik zamanlayıcı seçeneği
- Kolay değiştirilebilir teflon pişirme kalıpları
- Paslanmaz çelik gömülü ısıtıcılar ile hassas sıcaklık kontrolü
- Farklı sıcaklık ayarında çalıştırma
- Seri pişirmelerde yüksek performans
- Gösterge ve sinyal lambaları
- Paslanmaz çelik alt gövde
- Gıda ile temasa uygun pişirme kalıpları ve gövde
- **Teflon kaplı yapışmaz pişirme yüzeyi ve üst gövde**
- **Farklı şekillerde değiştirilebilir pişirme kalıpları**

EN

- Mechanic timer model options
- Different shaped baking plates feature
- Stainless steel embedded heating element for precise temperature control
- Operation with desired heating temperature
- High performance during dynamic operation
- Power ON and Ready-to-Bake LED indicators
- Stainless steel frame body
- Baking plates and body suitable for food contact
- **Teflon coated Non-Stick baking plate and top body**
- **Easy to change teflon coated baking plates**

KOD / CODE	 (MM)			 (KW)	€
AIM WFL21R	225x450x250	230V - 50-60Hz	7	1,3	-
AIM WFL22R	225x450x250	230V - 50-60Hz	7	1,3	-
AIM WFL23R	225x450x250	230V - 50-60Hz	7	1,3	-
AIM WFL24R	225x450x250	230V - 50-60Hz	7	1,3	-



KRP21



KRP22



PNK21



PNK22







TEKNİK DETAYLAR / TECHNICAL DETAILS

TR

- Teflon ve pişirme yüzeyi
- Farklı şekillerde pişirme kalıpları
- Paslanmaz çelik gömülü ısıtıcılar ile hassas sıcaklık kontrolü
- Farklı sıcaklık ayarında çalıştırma
- Seri pişirmelerde yüksek performans
- Gösterge ve sinyal lambası
- Paslanmaz çelik gövde
- Gıda ile temasa uygun pişirme kalıpları ve gövde

EN

- Teflon coated non stick baking plate
- Different shaped baking plates feature
- Stainless steel embedded heating element for precise temperature control
- Operation with desired heating temperature
- High performance during dynamic operation
- Power ON and Ready-to-Bake LED indicator
- Stainless steel body
- Baking plates and body suitable for food contact

KOD / CODE	 (MM)	KAPASİTE / CAPACITY		 kg	 (KW)	€
AIM KRP21	405x400x180	1xØ400	230V - 50-60Hz	15	2,5	-
AIM KRP22	405x400x180	7xØ95	230V - 50-60Hz	15	2,5	-
AIM PNK21	405x400x180	14xØ78	230V - 50-60Hz	15	2,5	-
AIM PNK22	405x400x180	37xØ40	230V - 50-60Hz	15	2,5	-

BAR BLENDİRLARI BAR BLENDERS

BLE3-R



BLE3-B



BLE2-R



BLE2-B



BUZ KIRMA ÖZELLİĞİ
ICE CRUSHER FEATURE







TEKNİK DETAYLAR / TECHNICAL DETAILS

TR

- Manuel ve dijital model seçeneği
- Karıştırma ve parçalama özelliği
- Max 25.000 RPM çalışma hızı
- Kapak sensörlü
- 3 veya 2 lt sürahi kapasitesi
- Hız kontrolü
- Buz kırma özelliği
- ABS gövde
- Gıda ile temasa uygun polikarbon sürahi

EN

- Manual and digital model option
- Mix and pulse option
- Max. 25.000 RPM working speed
- Lid sensor
- 3 or 2 lt jug capacity
- Speed control
- Ice crushing feature
- ABS Body
- Polycarbonate container suitable for food contact

KOD / CODE	 (MM)	 lt		 kg	 (KW)	€
AIM BLE3-R	210x240x490	3	230V - 50Hz	4,7	2,2	-
AIM BLE3-B	210x240x490	3	230V - 50Hz	4,7	2,2	-
AIM BLE2-R	210x240x430	2	230V - 50Hz	4,5	2,2	-
AIM BLE2-B	210x240x430	2	230V - 50Hz	4,5	2,2	-

CLM01

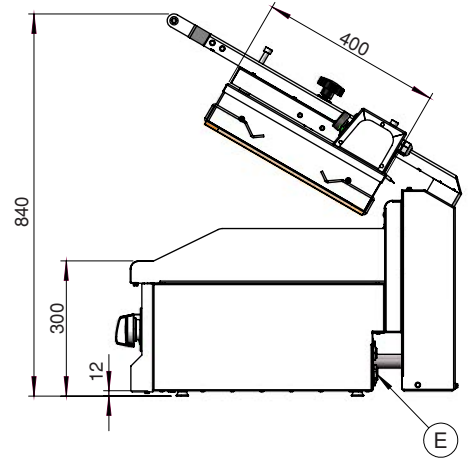





TEKNİK DETAYLAR / TECHNICAL DETAILS

TR

- Çelik alt ve üst plakalar
- Yapışmaz ızgara yüzeyi için teflon film kaplı üst plaka
- Üst ve alt plaka için ayrı termostatik kontrol
- Üst plaka için maksimum 250 °C, alt plaka için maksimum 300 °C çalışma sıcaklığı
- Üst plaka kapatıldığında ızgara olarak çalıştırılabilir

EN

- Steel lower and upper plates
- Teflon film coated upper plate for nonstick grill surface
- Separate thermostatic control for upper and lower plate
- For upper plate max 250 °C for lower plate 300 °C max operating temperature
- Can be operated as grill when upper plate is turned off

KOD / CODE	 (MM)		 kg	 (KW)	
AIM CLM01	810x400x500	400V - 50-60Hz	64	6,2	-

EKMEK KIZARTMA MAKİNESİ BUN TOASTER

BUN01



BUN02



BTW



BUTTER
WHEELER

KOD / CODE	(MM)	€
AIM BTW	180x160x130	-

TEKNİK DETAYLAR / TECHNICAL DETAILS

TR

- Paslanmaz çelik gövde
- 10-50 mm aralığında ayarlanabilir mesafe
- 100 °C - 350 °C arası ayarlanabilir çalışma sıcaklığı
- BUN01 modeli için; 18-60 saniye konveyör hızı
- BUN02 modeli için; 22 saniye konveyör hızı
- Ergonomik tasarım ve kolay temizleme imkanı.

EN

- Stainless steel body
- 10-50 mm adjustable distance
- 100 °C - 350 °C temperature range
- 18-60 seconds conveyor speed for BUN01 model
- 22 seconds constant conveyor speed for BUN02 model
- Ergonomic design providing convenience to users in all aspects.

KOD / CODE	(MM)	⏻	kg	(kW)	€
AIM BUN01	700x235x720	220-240 V	42	2	-
AIM BUN02	650x235x730	380-410 V	38	2	-

PG03



PG02



PG01







TEKNİK DETAYLAR / TECHNICAL DETAILS

TR

- Üst ve alt nervürlü ızgara plakası
- 50 °C - 300 °C arası ayarlanabilir çalışma sıcaklığı
- Isıya dayanıklı bakalit kulp
- Ayarlanabilir termostat

EN

- Grill plate ribbed at the top & bottom
- 50 °C - 300 °C temperature range
- Heat resistant handle
- Adjustable thermostat

KOD / CODE	 (MM)		 kg	 (KW)	€
AIM PG01	410x500x300	220-240 V	29	2,5	-
AIM PG02	510x500x300	220-240 V	33	3	-
AIM PG03	500x440x300	220-240 V	34	3,5	-

ELEKTRİKLI SALAMANDER ELECTRIC SALAMANDER

ESL4







TEKNİK DETAYLAR / TECHNICAL DETAILS

TR

- Termostatik kontrol.
- Yüksekliği ayarlanabilir su ve yağ çekmecesi.
- Paslanmaz çelik gövde.
- Hijyenik kullanım için pislik tavası.

EN

- Thermostatic control.
- Height-adjustable collection tray for grease and water
- High-quality construction
- Made from stainless steel

KOD / CODE	 (MM)		 kg	 (KW)	€
AIM ESL2	450X500X540	220-240 V	35	2,8	-
AIM ESL4	600X500X540	220-240 V	47	3	-

GSL6

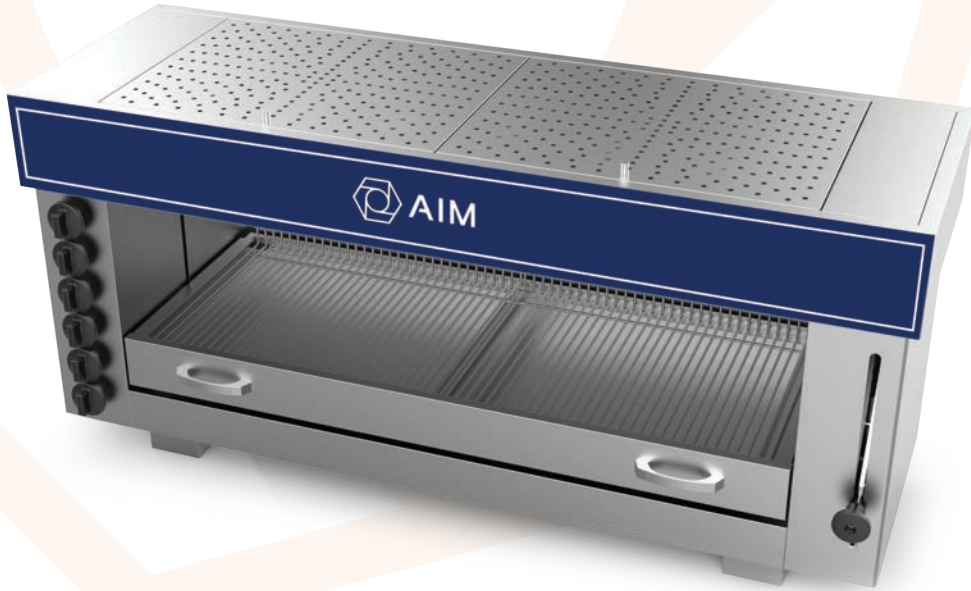

GSL2



GSL4





TEKNİK DETAYLAR / TECHNICAL DETAILS

TR

- Seramik brülörler.
- Yüksekliği ayarlanabilir su ve yağ çekmecesi.
- Paslanmaz çelik gövde.
- Hijyenik kullanım için pislik tavası.

EN

- Ceramic burner
- Standard version on natural gas
- Height-adjustable collection tray for grease and water
- High-quality construction
- Made from stainless steel

KOD / CODE	 (MM)	BURNER	 (kg)	 (KW)	€
AIM GSL2	650x430x600	2	38	5,4	-
AIM GSL4	960x430x600	4	55	10,8	-
AIM GSL6	1290x430x600	6	75	16,2	-

İNDİKSİYON OCAKLARI INDUCTION COOKERS

IND







TEKNİK DETAYLAR / TECHNICAL DETAILS

TR

- Seramik cam pişirme yüzeyi
- Tekli ve çiftli model seçeneği
- Çok kısa sürede pişirme imkânı ile enerji tasarrufu
- Dijital kontrol paneli ile kullanım kolaylığı
- Elektronik zaman ayarı
- Farklı sıcaklık ayarında çalıştırma
- Seri pişirmelerde yüksek performans
- Paslanmaz çelik gövde

EN

- Vitro -ceramic glass cooking surface
- Single and double model options
- Energy saving with the possibility of cooking in a very short time
- Easy operation with digital control panel
- Electronic timer
- Operation with desired heating temperature
- High performance during dynamic operation
- Stainless steel body

KOD / CODE	 (MM)		 kg	 (KW)	
AIM IND	500x400x130	230V 50-60Hz	8	3,5	-





TEKNİK DETAYLAR / TECHNICAL DETAILS

TR

- LPGli ve NG seçenekleri mevcuttur.
- Emniyet ventili kontrol dışı sönen radyanlara giden gazı otomatik olarak keser.
- Üstten motorlu çift yöne döndürebilme özelliğine sahiptir.
- Döner ocağı kanatları mevcut değildir, opsiyonel olarak takılabilir.
- Üstten motorlu döner ocaklarında, motorun arıza yapması durumunda döner ocağı manuel olarak kullanılabilir.
- Üstten motorlu döner ocaklarında, alev perdesi motorla beraber hareket ettiği için motorun ömrünü uzatır.
- Paslanmaz et toplama tepsi.
- Hareketli şiş tutucu sayesinde eti yakınlaştırma ve uzaklaştırma imkanı.
- Delikli tepsi sayesinde yağlı süzdürme imkanı.

EN

- LPG and NG options available.
- Safety valve automatically cuts off the gas from the radiant heaters that go out unexpectedly.
- Electric motor installed at the top rotates in both directions.
- Side flaps are available as an option.
- In case of failure of the electric motor, the machine can be controlled manually.
- Flame curtain moving along with the motor extends the life of the motor.
- Stainless steel meat tray.
- Movable skewer holder maintain forward and backward moving.
- Holed tray helps easy fat dripping.

KOD / CODE	 (MM)	BURNER	 kg	 (KW)	€
AIM DMT3	630x825x975	3	30	10,2	-
AIM DMT4	630x825x1140	4	35	13,6	-
AIM DMT5	630x825x1310	5	38	17	-

DÖNER OCAKLARI - ALTTAN MOTOR DONER MACHINES - BOTTOM MOTOR





TEKNİK DETAYLAR / TECHNICAL DETAILS

TR

- LPGli ve NG seçenekleri mevcuttur.
- Emniyet ventili kontrol dışı sönen radyanlara giden gazı otomatik olarak keser.
- Üstten motorlu çift yöne döndürebilme özelliğine sahiptir.
- Döner ocağı kanatları mevcut değildir, opsiyonel olarak takılabilir.
- Üstten motorlu döner ocaklarında, motorun arıza yapması durumunda döner ocağı manuel olarak kullanılabilir.
- Üstten motorlu döner ocaklarında, alev perdesi motorla beraber hareket ettiği için motorun ömrünü uzatır.
- Paslanmaz et toplama tepsisi.
- Hareketli şiş tutucu sayesinde eti yakınlaştırma ve uzaklaştırma imkanı.
- Delikli tepsi sayesinde yağı süzdürme imkanı.

EN

- LPG and NG options available.
- The motor can be controlled on the device itself.
- The body can be moved back and forth to adjust the distance to the meat.
- Dripping fat from the meat can be easily drained to the discharge drawer from the inclined tray for easy removal.
- Safety valve automatically cuts off the gas from the radiant heaters that go out unexpectedly.
- Use of manual motor in case of power outages.
- Electric motor installed at the bottom rotates in both directions.
- Tray and side flaps are available as an option.





KOD / CODE	 (MM)	BURNER	 kg	 (KW)	€
AIM DMB3	575x715x960	3	38	10,2	-
AIM DMB4	575x715x1135	4	43	13,6	-
AIM DMB5	575x715x1300	5	48	17	-

PF80



PF40



KOD / CODE	PİZZA KAPASİTESİ / PIZZA CAPACITY	KAT SAYISI / DECK (MM)	 (MM)			 (KW)	€
AIM PF40	1 x Ø40	410x410	575x530x270	230V	23	3	-
AIM PF80	1+1 x Ø40	2x 410x410	575x530x490	230V	44	3+3	-







PF100







PF200



KOD / CODE	PİZZA KAPASİTESİ / PIZZA CAPACITY	KAT SAYISI / DECK (MM)	 (MM)			 (KW)	€
AIM PF100	4 x Ø25	510x510	735x650x320	230V	32	4	-
AIM PF200	4+4 x Ø25	2x 510x510	735x650x490	380V	65	4+4	-

PIZZA FIRINLARI PIZZA OVENS



KOD / CODE	PIZZA KAPASİTESİ / PIZZA CAPACITY	KAT SAYISI / DECK (MM)	 (MM)		 kg	 (kW)	€
AIM PF120	4 x Ø30	620x620	860x800x390	380V	62	5	-
AIM PF240	4+4 x Ø30	2x 620x620	860x800x680	380V	105	5+5	-
AIM PF132	4 x Ø33	720x720	960x900x390	380V	68	5,7	-
AIM PF264	4+4 x Ø33	2x 720x720	960x900x680	380V	120	5,7+5,7	-
AIM PF180	6 x Ø30	920x620	1160x800x390	380V	80	6	-
AIM PF360	6+6 x Ø30	2x 920x620	1160x800x680	380V	142	6+6	-
AIM PF198	6 x Ø33	1050x720	1290x900x390	380V	92	8,4	-
AIM PF396	6+6 x Ø33	2x 1050x720	1290x900x680	380V	158	8,4+ 8,4	-
AIM PF270	9 x Ø30	920x920	1160x1110x390	380V	120	10	-
AIM PF540	9+9 x Ø30	2x 920x920	1160x1110x680	380V	210	10+10	-

TEKNİK DETAYLAR / TECHNICAL DETAILS

TR

- Fırın içi ısı kaybını minimuma indiren yoğun izolasyon
- Pişirme yüzeyi için ısının homojen dağılımını sağlayan özel üretilmiş doğal REFRAKTER taban taşı
- Isıya dayanıklı aydınlatma lambası
- Gözetleme penceresi
- Her kat için üst ve alt sıcaklığın ayarlandığı iki adet termostat (50 ° - 450 °C)
- Özel manuel sıcaklık göstergesi Termometre
- Paslanmaz çelik ön panel
- Bağımsız, Açma/Kapama anahtarı

EN

- Insulation with high quality and high density rock wool for better energy saving
- Oven made of high quality Natural, made refractory stone
- Heat resistant Illumination Lamp for Baking Chamber
- Large fire proof safety glass window
- Separate temperature control for top and bottom heat by thermostat (50 ° - 450 °C). · Thermometer for temperature display
- Stainless Steel front body
- Separated on / off switch for each baking chamber



KOD / CODE	 (MM)	€
AIM PB1	515x695x830	-
AIM PB4	607x825x830	-
AIM PB4L	707x907x830	-
AIM PB6	1125x825x830	-
AIM PB6L	707x1275x830	-
AIM PB9	907x1125x830	-







TEKNİK DETAYLAR / TECHNICAL DETAILS

TR

- Sabit hız ve paslanmaz çelik bıçak
- Parçalayıcı (300 mm)
- Çırpıcı Aparat (360 mm-Combi modeller için)
- Easy lock sistemi ile kolay kullanım
- Devir hızı: 13000 rpm

EN

- Constant speed and stainless steel blade
- Mixer arm 300 mm
- Whisk (360 mm-Combi models only)
- Easy to use with Easy lock system
- Revolution: 13000 rpm

KOD / CODE	 (MM)		 kg	 (KW)	€
AIM IB30	130x98x595	350	2,25	220 V - 1N	-
AIM IB30K	130x98x595	350	3,15	220 V - 1N	-

EL BLENDER – 40 CM

IMMERSION BLENDERS – 40 CM







TEKNİK DETAYLAR / TECHNICAL DETAILS

TR

- Kademeli hız ayarı ve paslanmaz çelik bıçak
- Parçalayıcı aparat (400 mm)
- Çirpici Apart (360 mm-Combi modeller için)
- Easy lock sistemi ile kolay kullanım
- Devir hızı: 11000 rpm max

EN

- Gradual speed adjustment and stainless steel blade
- Mixer arm (400 mm)
- Whisk (360 mm-Combi models only)
- Easy to use with Easy lock system
- Revolution: 11000 rpm max

KOD / CODE	 [MM]		 kg	 [KW]	€
AIM IB40	146×120×790	650	3,90	220 V - 1N	-
AIM IB40K	146×120×790	650	4,90	220 V - 1N	-

INOX
SERVIS
EKİPMANLARI



INOX
SERVICE
EQUIPMENT



WTF



WTF-S



TEKNİK DETAYLAR / TECHNICAL DETAILS

TR

- Paslanmaz Çelik AISI 430'dan üretilmiştir
- Kolay kurulma imkanı
- Yuvarlatılmış köşeler
- Alt rafsız
- Yüksekliği ayarlanabilir
- Kare profil 40 x 40 mm
- MDF ile güçlendirilmiş çalışma yüzeyi (ses geçirmez)
- Tek / Çift / Üçlü Çekmece montaj imkanı
- Sırtlıklı modellerde 10cm sırtlık

EN

- Brushed Structure Stainless Steel AISI 430
- Self Assembly
- Rounded corners
- Without Undershef
- Adjustable in height
- Square profile 40 x 40 mm
- Working surface reinforced with MDF (sound proof)
- Single / Double / Tripple Drawers mounting possibility
- 10cm Backsplash models on WTF-S models

KOD CODE		[MM]		€	
600 MM	700 MM	600 MM	700 MM	600 MM	700 MM
WTF-706085	WTF-707085	700x600x850	700x700x850	-	-
WTF-806085	WTF-807085	800x600x850	800x700x850	-	-
WTF-906085	WTF-907085	900x600x850	900x700x850	-	-
WTF-1006085	WTF-1007085	1000x600x850	1000x700x850	-	-
WTF-1206085	WTF-1207085	1200x600x850	1200x700x850	-	-
WTF-1406085	WTF-1407085	1400x600x850	1400x700x850	-	-
WTF-1506085	WTF-1507085	1500x600x850	1500x700x850	-	-
WTF-1606085	WTF-1607085	1600x600x850	1600x700x850	-	-
WTF-1806085	WTF-1807085	1800x600x850	1800x700x850	-	-
WTF-2006085	WTF-2007085	2000x600x850	2000x700x850	-	-

KOD CODE		[MM]		€	
600 MM	700 MM	600 MM	700 MM	600 MM	700 MM
WTF-706085-S	WTF-707085-S	700x600x850	700x700x850	-	-
WTF-806085-S	WTF-807085-S	800x600x850	800x700x850	-	-
WTF-906085-S	WTF-907085-S	900x600x850	900x700x850	-	-
WTF-100608-S	WTF-100708-S	1000x600x850	1000x700x850	-	-
WTF-1206085-S	WTF-1207085-S	1200x600x850	1200x700x850	-	-
WTF-1406085-S	WTF-1407085-S	1400x600x850	1400x700x850	-	-
WTF-1506085-S	WTF-1507085-S	1500x600x850	1500x700x850	-	-
WTF-1606085-S	WTF-1607085-S	1600x600x850	1600x700x850	-	-
WTF-1806085-S	WTF-1807085-S	1800x600x850	1800x700x850	-	-
WTF-2006085-S	WTF-2007085-S	2000x600x850	2000x700x850	-	-

ÇALIŞMA TEZGAHLARI - ALT RAFLI - DEMONTE WORK TABLE - W/U - FLAT PACKED

WTF-A



WTF-SA



TEKNİK DETAYLAR / TECHNICAL DETAILS

TR

- Paslanmaz Çelik AISI 430'dan üretilmiştir
- Kolay kurulma imkanı
- Yuvarlatılmış köşeler
- Alt raflı
- Yüksekliği ayarlanabilir
- Kare profil 40 x 40 mm
- MDF ile güçlendirilmiş çalışma yüzeyi (ses geçirmez)
- Tek / Çift / Üçlü Çekmece montaj imkanı
- 10cm Backsplash models on WTF-SA models

EN

- Brushed Structure Stainless Steel AISI 430
- Self Assembly
- Rounded corners
- With Undershelf
- Adjustable in height
- Square profile 40 x 40 mm
- Working surface reinforced with MDF (sound proof)
- Single / Double / Tripple Drawers mounting possibility
- Sırtlıklı modellerde 10cm sırtlık

KOD CODE		↑ ↓ (MM)		€	
600 MM	700 MM	600 MM	700 MM	600 MM	700 MM
WTF-706085-A	WTF-707085-A	700x600x850	700x700x850	-	-
WTF-806085-A	WTF-807085-A	800x600x850	800x700x850	-	-
WTF-906085-A	WTF-907085-A	900x600x850	900x700x850	-	-
WTF-1006085-A	WTF-1007085-A	1000x600x850	1000x700x850	-	-
WTF-1206085-A	WTF-1207085-A	1200x600x850	1200x700x850	-	-
WTF-1406085-A	WTF-1407085-A	1400x600x850	1400x700x850	-	-
WTF-1506085-A	WTF-1507085-A	1500x600x850	1500x700x850	-	-
WTF-1606085-A	WTF-1607085-A	1600x600x850	1600x700x850	-	-
WTF-1806085-A	WTF-1807085-A	1800x600x850	1800x700x850	-	-
WTF-2006085-A	WTF-2007085-A	2000x600x850	2000x700x850	-	-

KOD CODE		↑ ↓ (MM)		€	
600 MM	700 MM	600 MM	700 MM	600 MM	700 MM
WTF-706085-SA	WTF-707085-SA	700x600x850	700x700x850	-	-
WTF-806085-SA	WTF-807085-SA	800x600x850	800x700x850	-	-
WTF-906085-SA	WTF-907085-SA	900x600x850	900x700x850	-	-
WTF-1006085-SA	WTF-1007085-SA	1000x600x850	1000x700x850	-	-
WTF-1206085-SA	WTF-1207085-SA	1200x600x850	1200x700x850	-	-
WTF-1406085-SA	WTF-1407085-SA	1400x600x850	1400x700x850	-	-
WTF-1506085-SA	WTF-1507085-SA	1500x600x850	1500x700x850	-	-
WTF-1606085-SA	WTF-1607085-SA	1600x600x850	1600x700x850	-	-
WTF-1806085-SA	WTF-1807085-SA	1800x600x850	1800x700x850	-	-
WTF-2006085-SA	WTF-2007085-SA	2000x600x850	2000x700x850	-	-

WTF-2A



WTF-S2A



TEKNİK DETAYLAR / TECHNICAL DETAILS

TR

- Paslanmaz Çelik AISI 430'dan üretilmiştir
- Kolay kurulma imkanı
- Yuvarlatılmış köşeler
- Alt rafsız
- Yüksekliği ayarlanabilir
- Kare profil 40 x 40 mm
- MDF ile güçlendirilmiş çalışma yüzeyi (ses geçirmez)
- Tek / Çift / Üçlü Çekmece montaj imkanı
- Sırtlıklı modellerde 10cm sırtlık

EN

- Brushed Structure Stainless Steel AISI 430
- Rounded corners
- Rounded corners
- With Undershelf + Center Shelf
- Adjustable in height
- Square profile 40 x 40 mm
- Working surface reinforced with MDF (sound proof)
- Single / Double / Tripple Drawers mounting possibility
- 10cm Backsplash models on WTF-S2A models

KOD CODE		 (MM)		€	
600 MM	700 MM	600 MM	700 MM	600 MM	700 MM
WTF-706085-2A	WTF-707085-2A	700x600x850	700x700x850	-	-
WTF-806085-2A	WTF-807085-2A	800x600x850	800x700x850	-	-
WTF-906085-2A	WTF-907085-2A	900x600x850	900x700x850	-	-
WTF-1006085-2A	WTF-1007085-2A	1000x600x850	1000x700x850	-	-
WTF-1206085-2A	WTF-1207085-2A	1200x600x850	1200x700x850	-	-
WTF-1406085-2A	WTF-1407085-2A	1400x600x850	1400x700x850	-	-
WTF-1506085-2A	WTF-1507085-2A	1500x600x850	1500x700x850	-	-
WTF-1606085-2A	WTF-1607085-2A	1600x600x850	1600x700x850	-	-
WTF-1806085-2A	WTF-1807085-2A	1800x600x850	1800x700x850	-	-
WTF-2006085-2A	WTF-2007085-2A	2000x600x850	2000x700x850	-	-

KOD CODE		 (MM)		€	
600 MM	700 MM	600 MM	700 MM	600 MM	700 MM
WTF-706085-S2A	WTF-707085-S2A	700x600x850	700x700x850	-	-
WTF-806085-S2A	WTF-807085-S2A	800x600x850	800x700x850	-	-
WTF-906085-S2A	WTF-907085-S2A	900x600x850	900x700x850	-	-
WTF-1006085-S2A	WTF-1007085-S2A	1000x600x850	1000x700x850	-	-
WTF-1206085-S2A	WTF-1207085-S2A	1200x600x850	1200x700x850	-	-
WTF-1406085-S2A	WTF-1407085-S2A	1400x600x850	1400x700x850	-	-
WTF-1506085-S2A	WTF-1507085-S2A	1500x600x850	1500x700x850	-	-
WTF-1606085-S2A	WTF-1607085-S2A	1600x600x850	1600x700x850	-	-
WTF-1806085-S2A	WTF-1807085-S2A	1800x600x850	1800x700x850	-	-
WTF-2006085-S2A	WTF-2007085-S2A	2000x600x850	2000x700x850	-	-

BLOK ÇEKMECELER - TEZGAHA MONTE BLOCK DRAWER - FOR UNDER WORK TABLE

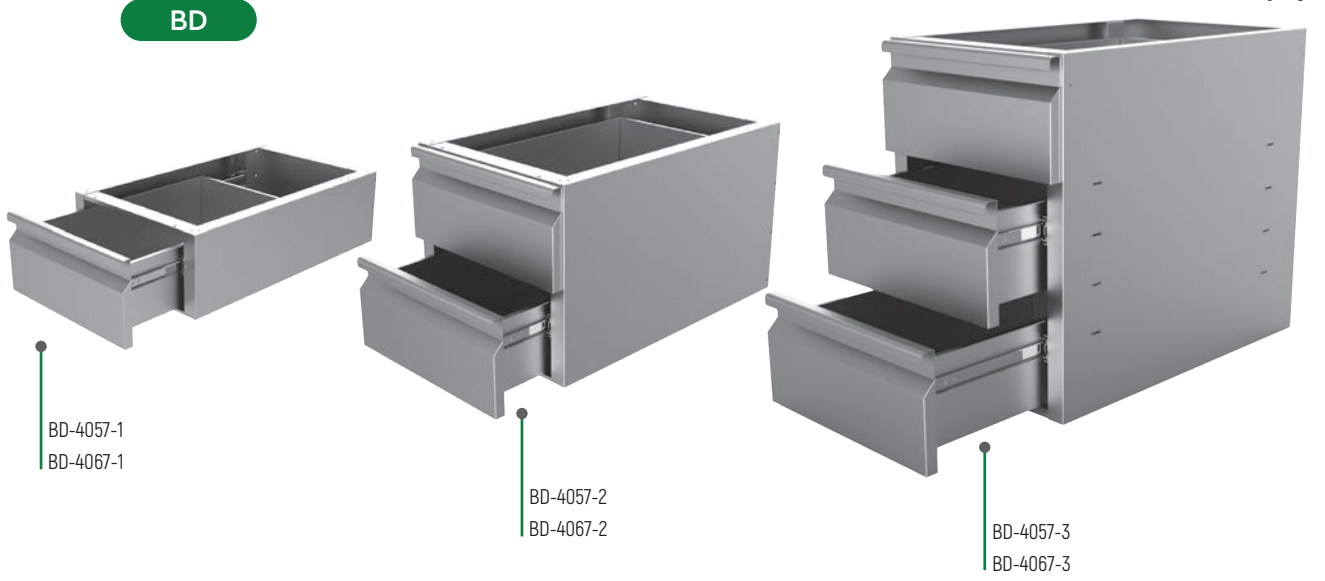

TEKNİK DETAYLAR / TECHNICAL DETAILS

TR

- Paslanmaz Çelik AISI 430'dan üretilmiştir
- 600/700 serisine uygun blok çekmece
- Yavaş açma / kapama
- Kolay kurulum

EN

- Made of brushed stainless steel AISI 430
- Block drawer suitable for 600/700 series
- Soft open / close
- Easy construction

KOD CODE		[MM]		€	
600 MM	700 MM	600 MM	700 MM	600 MM	700 MM
BD-4057-1	BD-4067-1	400x570	400x670	-	-
BD-4057-2	BD-4067-2	400x570	400x670	-	-
BD-4057-3	BD-4067-3	400x570	400x670	-	-

BD seri blok çekmeceler tezgaha monte olarak kullanılmaktadır.
BD line block drawers can be used only with work tables.

WTF-WO

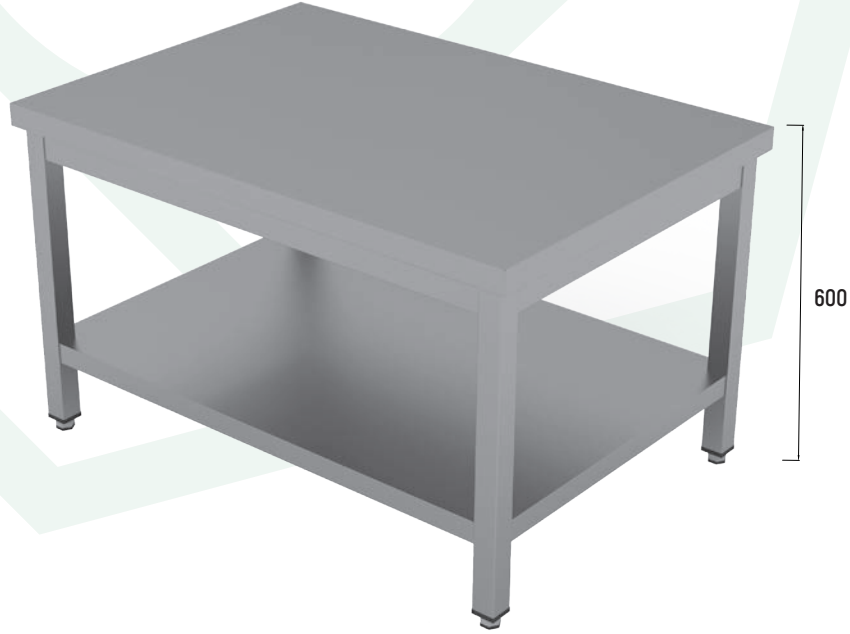

TEKNİK DETAYLAR / TECHNICAL DETAILS

TR

- Paslanmaz Çelik AISI 430'dan üretilmiştir
- Alt raflı
- Yüksekliği ayarlanabilir
- Kare profil 40 x 40 mm
- MDF ile güçlendirilmiş çalışma yüzeyi (ses geçirmez)

EN

- Brushed Structure Stainless Steel AISI 430
- With Underself
- Adjustable in height
- Square profile 40 x 40 mm
- Working surface reinforced with MDF (sound proof)

KOD CODE	 (MM)	€
700 MM	700 MM	700 MM
WTF-1007060-WO	1000x700x600	-
WTF-1207060-WO	1200x700x600	-
WTF-1407060-WO	1400x700x600	-
WTF-1607060-WO	1600x700x600	-
WTF-1807060-WO	1800x700x600	-
WTF-2007060-WO	2000x700x600	-

ÇALIŞMA TEZGAHLARI - SÜRGÜ KAPAKLI WORK TABLE - SLIDING DOORS

WT-S



WT-SS



TEKNİK DETAYLAR / TECHNICAL DETAILS

TR

- Paslanmaz Çelik AISI 430'dan üretilmiştir
- MDF ile güçlendirilmiş çalışma yüzeyi (ses geçirmez)
- Entegre kulplu sürgülü kapılar
- Yüksekliği ayarlanabilen paslanmaz çelik ayaklar
- Sırtlıklı modellerde 10cm sırtlık

EN

- Brushed structure stainless steel AISI 430
- Working surface reinforced with MDF (sound proof)
- Sliding doors with integrated handle
- Stainless steel legs adjustable in height
- 10cm Backsplash models on WTF-SS models



KOD CODE		[MM]		€	
600 MM	700 MM	600 MM	700 MM	600 MM	700 MM
WT-1006085-S	WT-1007085-S	1000x600x850	1000x700x850	-	-
WT-1206085-S	WT-1207085-S	1200x600x850	1200x700x850	-	-
WT-1406085-S	WT-1407085-S	1400x600x850	1400x700x850	-	-
WT-1506085-S	WT-1507085-S	1500x600x850	1500x700x850	-	-
WT-1606085-S	WT-1607085-S	1600x600x850	1600x700x850	-	-
WT-1806085-S	WT-1807085-S	1800x600x850	1800x700x850	-	-
WT-2006085-S	WT-2007085-S	2000x600x850	2000x700x850	-	-



KOD CODE		[MM]		€	
600 MM	700 MM	600 MM	700 MM	600 MM	700 MM
WT-1006085-SS	WT-1007085-SS	1000x600x850	1000x700x850	-	-
WT-1206085-SS	WT-1207085-SS	1200x600x850	1200x700x850	-	-
WT-1406085-SS	WT-1407085-SS	1400x600x850	1400x700x850	-	-
WT-1506085-SS	WT-1507085-SS	1500x600x850	1500x700x850	-	-
WT-1606085-SS	WT-1607085-SS	1600x600x850	1600x700x850	-	-
WT-1806085-SS	WT-1807085-SS	1800x600x850	1800x700x850	-	-
WT-2006085-SS	WT-2007085-SS	2000x600x850	2000x700x850	-	-

Kapaklar çift cidarlıdır.

Doors are double skin.

WT-2S



WT-H-2S



TEKNİK DETAYLAR / TECHNICAL DETAILS

TR

- Paslanmaz Çelik AISI 430'dan üretilmiştir
- Wok için özel üretim
- Alt Rafı
- Yüksekliği ayarlanabilir
- MDF ile güçlendirilmiş çalışma yüzeyi (ses geçirmez)
- Sıcaklık aralığı: +30 / + 80 °C. (WT-H-2S)
- Elektrik gücü: 230V / 1N 50-60Hz (WT-H-2S)
- Kw: 1,5 (WT-H-2S)

EN

- Brushed Structure Stainless Steel AISI 430
- Special production for the Wok
- With Undershef
- Adjustable in height
- Working surface reinforced with MDF (sound proof)
- Temperature range: +30 / + 80 °C. (WT-H-2S)
- Electrical power: 230V / 1N 50-60Hz (WT-H-2S)
- Kw: 1.5 (WT-H-2S)

KOD CODE		[MM]		€	
600 MM	700 MM	600 MM	700 MM	600 MM	700 MM
WT-1006085-2S	WT-1007085-2S	1000x600x850	1000x700x850	-	-
WT-1206085-2S	WT-1207085-2S	1200x600x850	1200x700x850	-	-
WT-1406085-2S	WT-1407085-2S	1400x600x850	1400x700x850	-	-
WT-1506085-2S	WT-1507085-2S	1500x600x850	1500x700x850	-	-
WT-1606085-2S	WT-1607085-2S	1600x600x850	1600x700x850	-	-
WT-1806085-2S	WT-1807085-2S	1800x600x850	1800x700x850	-	-
WT-2006085-2S	WT-2007085-2S	2000x600x850	2000x700x850	-	-

KOD CODE	[MM]	€
700 MM	700 MM	700 MM
WT-1007085-H-2S	1000x700x850	-
WT-1207085-H-2S	1200x700x850	-
WT-1407085-H-2S	1400x700x850	-
WT-1507085-H-2S	1500x700x850	-
WT-1607085-H-2S	1600x700x850	-
WT-1807085-H-2S	1800x700x850	-
WT-2007085-H-2S	2000x700x850	-

Kapaklar çift cidarlıdır.

Doors are double skin.

ÇALIŞMA TEZGAHLARI - ISITMALI - FANLI HEATED CUPBOARD - FAN

WT-H

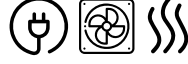

WT-SH



TEKNİK DETAYLAR / TECHNICAL DETAILS

TR

- Paslanmaz Çelik AISI 430'dan üretilmiştir
- Tezgah güçlendirilmiş ve ses emici izolasyonla donatılmıştır.
- Termal sıcaklık kontrolü
- Sıcaklık aralığı: +30 / + 80 °C.
- Entegre kulplu sürgülü kapılar
- Yüksekliği ayarlanabilen paslanmaz çelik ayaklar
- Elektrik gücü: 230V / 1N 50-60Hz
- Kw: 1,5

EN

- Brushed structure stainless steel AISI 430
- Worktop reinforced and fitted with sound-absorbing isolation.
- Thermal temperature control
- Temperature range: +30 / + 80 °C.
- Sliding doors with integrated handle
- Stainless steel legs adjustable in height
- Electrical power: 230V / 1N 50-60Hz
- Kw: 1.5

KOD CODE		[MM]		€	
600 MM	700 MM	600 MM	700 MM	600 MM	700 MM
WT-1006085-H	WT-1007085-H	1000x600x850	1000x700x850	-	-
WT-1206085-H	WT-1207085-H	1200x600x850	1200x700x850	-	-
WT-1406085-H	WT-1407085-H	1400x600x850	1400x700x850	-	-
WT-1506085-H	WT-1507085-H	1500x600x850	1500x700x850	-	-
WT-1606085-H	WT-1607085-H	1600x600x850	1600x700x850	-	-
WT-1806085-H	WT-1807085-H	1800x600x850	1800x700x850	-	-
WT-2006085-H	WT-2007085-H	2000x600x850	2000x700x850	-	-

KOD CODE		[MM]		€	
600 MM	700 MM	600 MM	700 MM	600 MM	700 MM
WT-1006085-SH	WT-1007085-SH	1000x600x850	1000x700x850	-	-
WT-1206085-SH	WT-1207085-SH	1200x600x850	1200x700x850	-	-
WT-1406085-SH	WT-1407085-SH	1400x600x850	1400x700x850	-	-
WT-1506085-SH	WT-1507085-SH	1500x600x850	1500x700x850	-	-
WT-1606085-SH	WT-1607085-SH	1600x600x850	1600x700x850	-	-
WT-1806085-SH	WT-1807085-SH	1800x600x850	1800x700x850	-	-
WT-2006085-SH	WT-2007085-SH	2000x600x850	2000x700x850	-	-

Kapaklar çift cidarlıdır.

Doors are double skin.

INOX ÜRÜNLER INOX PRODUCTION

ÇALIŞMA TEZGAHLARI - BLOK ÇEKMECELİ - SÜRGÜ KAPAKLI
WORK TABLE - BLOCK DRAWERS - SLIDING DOOR

WTS -L / -R

WTS -SL / -SR



TEKNİK DETAYLAR / TECHNICAL DETAILS

TR

- Paslanmaz Çelik AISI 430'dan üretilmiştir
- MDF ile güçlendirilmiş çalışma yüzeyi (ses geçirmez)
- Entegre kulplu sürgülü kapılar
- 3 çekmeceli
- Yüksekliği ayarlanabilen paslanmaz çelik ayaklar
- Sırtlıklı modellerde 10cm sırtlık

EN

- Brushed structure stainless steel AISI 430
- Working surface reinforced with MDF (sound proof)
- Sliding doors with integrated handle
- With 3 drawers
- Stainless steel legs adjustable in height
- 10cm Backsplash models on WTF-SL/-SR models

KOD CODE		 (MM)		€	
700 L	700 R	700 L	700 R	700 L	700 R
WTS-1407085-L	WTS-1407085-R	1400x700x850	1400x700x850	-	-
WTS-1607085-L	WTS-1607085-R	1600x700x850	1600x700x850	-	-
WTS-1807085-L	WTS-1807085-R	1800x700x850	1800x700x850	-	-
WTS-2007085-L	WTS-2007085-R	2000x700x850	2000x700x850	-	-

KOD CODE		 (MM)		€	
700 SL	700 SR	700 SL	700 SR	700 SL	700 SR
WTS-1407085-SL	WTS-1407085-SR	1400x700x850	1400x700x850	-	-
WTS-1607085-SL	WTS-1607085-SR	1600x700x850	1600x700x850	-	-
WTS-1807085-SL	WTS-1807085-SR	1800x700x850	1800x700x850	-	-
WTS-2007085-SL	WTS-2007085-SR	2000x700x850	2000x700x850	-	-



ÇALIŞMA TEZGAHLARI - BLOK ÇEKMECELİ - SÜRGÜ KAPAKLI WORK TABLE - BLOCK DRAWERS - SLIDING DOOR

WTS-RL



WTS-RLS



TEKNİK DETAYLAR / TECHNICAL DETAILS

TR

- Paslanmaz Çelik AISI 430'dan üretilmiştir
- MDF ile güçlendirilmiş çalışma yüzeyi (ses geçirmez)
- 3 + 3 çekmeceli sol & sağ 1/1 GN
- Ortada entegre kulplu sürgülü kapılar
- Yüksekliği ayarlanabilen paslanmaz çelik ayaklar
- Sırtlıklı modellerde 10cm sırtlık

EN

- Brushed structure stainless steel AISI 430
- Working surface reinforced with MDF (sound proof)
- With 3 + 3 drawers left & right 1/1 GN
- Sliding doors in middle with integrated handle
- Stainless steel legs adjustable in height
- 10cm Backsplash models on WTS-RLS models

KOD CODE	 [MM]	€
700 MM	700 MM	700 MM
WTS-1807085-RL	1800x700x850	-
WTS-2007085-RL	2000x700x850	-
WTS-2407085-RL	2400x700x850	-



KOD CODE	 [MM]	€
700 MM	700 MM	700 MM
WTS-1807085-RLS	1800x700x850	-
WTS-2007085-RLS	2000x700x850	-
WTS-2407085-RLS	2400x700x850	-



WT-C



WT-SC

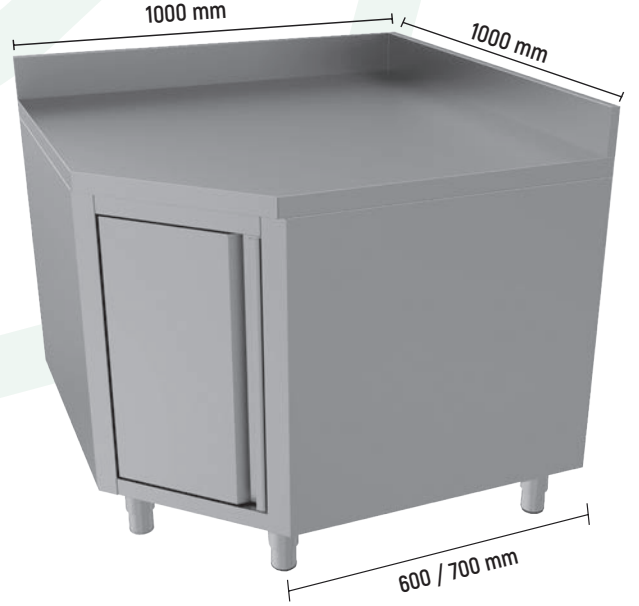

TEKNİK DETAYLAR / TECHNICAL DETAILS

TR

- Paslanmaz Çelik AISI 430'dan üretilmiştir
- MDF ile güçlendirilmiş çalışma yüzeyi (ses geçirmez)
- 600 ve 700 serisi çalışma tezgahları için kullanılabilir
- Sağlam yapı
- Orta raflı
- Yumuşak açma/kapama mekanizmalı kapı
- Yüksekliği ayarlanabilen paslanmaz çelik ayaklar
- Sırtlıklı modellerde 10cm sırtlık

EN

- Brushed structure stainless steel AISI 430
- Working surface reinforced with MDF (sound proof)
- Usable for the 600 & 700 serie worktables
- Robust construction
- With center shelf
- Door with soft open/close mechanism
- Stainless steel legs adjustable in height
- 10cm Backsplash models on WTF-SC models

KOD CODE	 (MM)	€
600-700	600-700	600-700
WT-10010085-C60	1000x1000x850	-
WT-10010085-C70	1000x1000x850	-

KOD CODE	 (MM)	€
600-700	600-700	600-700
WT-10010085-SC60	1000x1000x850	-
WT-10010085-SC70	1000x1000x850	-

ÇALIŞMA TEZGAHLARI - BLOK ÇEKMECELİ WORK TABLE - CORNER TYPE

WT-3D



WT-S3D



TEKNİK DETAYLAR / TECHNICAL DETAILS

TR

- Paslanmaz Çelik AISI 430'dan üretilmiştir
- MDF ile güçlendirilmiş çalışma yüzeyi (ses geçirmez)
- 3 çekmeceli
- Yüksekliği ayarlanabilen paslanmaz çelik ayaklar
- Sırtlıklı modellerde 10cm sırtlık

EN

- Brushed structure stainless steel AISI 430
- Working surface reinforced with MDF (sound proof)
- With 3 drawers
- Stainless steel legs adjustable in height
- 10cm Backsplash models on WT-S3D models



KOD CODE



(MM)



WT-507085-3D

500x700x850

-



KOD CODE



(MM)



WT-507085-S3D

500x700x850

-

DR-6

DR-6S



TEKNİK DETAYLAR / TECHNICAL DETAILS

TR

- Paslanmaz Çelik AISI 430'dan üretilmiştir
- Ayaklı / 6S modeli
- MDF ile güçlendirilmiş çalışma yüzeyi (ses geçirmez)
- Pizza hamur kutuları için 6 çekmeceli (600x400mm) 100MM
- Yüksekliği ayarlanabilen paslanmaz çelik ayaklar

EN

- Brushed structure stainless steel AISI 430
- With upstand / 6S model
- Working surface reinforced with MDF (sound proof)
- With 6 drawers for Pizza dough boxes (600x400mm) 100MM
- Stainless steel legs adjustable in height

KOD CODE	(MM)	€	KOD CODE	(MM)	€
DR-6	600x700x850	-	DR-6S	600x700x850	-

ÇALIŞMA TEZGAHLARI - 6 ÇEKMECELİ WORK TABLE - 6 DRAWERS

WT-6D



WT-S6D



TEKNİK DETAYLAR / TECHNICAL DETAILS

TR

- Paslanmaz Çelik AISI 430'dan üretilmiştir
- MDF ile güçlendirilmiş çalışma yüzeyi (ses geçirmez)
- 6 çekmeceli
- Yüksekliği ayarlanabilen paslanmaz çelik ayaklar
- Sırtlıklı modellerde 10cm sırtlık

EN

- Brushed structure stainless steel AISI 430
- Working surface reinforced with MDF (sound proof)
- With 6 drawers
- Stainless steel legs adjustable in height
- 10cm Backsplash models on WT-S3D models



KOD CODE	 (MM)	€
WT-1007085-6	1000x700x850	-



KOD CODE	 (MM)	€
WT-1007085-S6D	1000x700x850	-

CK



TEKNİK DETAYLAR / TECHNICAL DETAILS

TR

- Paslanmaz Çelik AISI 430'dan üretilmiştir
- Entegre kulplu açılır kapaklı kapılar
- Yüksekliği ayarlanabilen paslanmaz çelik ayaklar

EN

- Paslanmaz Çelik AISI 430'dan üretilmiştir
- Entegre kulplu açılır kapaklı kapılar
- Yüksekliği ayarlanabilen paslanmaz çelik ayaklar

KOD CODE		 (MM)		€	
600 MM	700 MM	600 MM	700 MM	600 MM	700 MM
CK-500-60	CK-500	500x600x850	500x700x850	-	-
CK-600-60	CK-600	600x600x850	600x700x850	-	-
CK-700-60	CK-700	700x600x850	700x700x850	-	-
CK-800-60	CK-800	800x600x850	800x700x850	-	-
CK-900-60	CK-900	900x600x850	900x700x850	-	-

ÇALIŞMA TEZGAHLARI - ÇARPMA KAPAKLI WORK TABLE - HINGED DOORS

CK-S



TEKNİK DETAYLAR / TECHNICAL DETAILS

TR

- Paslanmaz Çelik AISI 430'dan üretilmiştir
- MDF ile güçlendirilmiş çalışma yüzeyi (ses geçirmez)
- Entegre kulplu açılır kapaklı kapılar
- Yüksekliği ayarlanabilen paslanmaz çelik ayaklar
- Sırtlıklı modellerde 10cm sırtlık

EN

- Brushed structure stainless steel AISI 430
- Working surface reinforced with MDF (sound proof)
- Swing doors with integrated handle
- Stainless steel legs adjustable in height
- 10cm Backsplash models on CK-S models

KOD CODE		 [MM]		€	
600 MM	700 MM	600 MM	700 MM	600 MM	700 MM
CK-500-60-S	CK-500-S	500x600x850	500x700x850	-	-
CK-600-60-S	CK-600-S	600x600x850	600x700x850	-	-
CK-700-60-S	CK-700-S	700x600x850	700x700x850	-	-
CK-800-60-S	CK-800-S	800x600x850	800x700x850	-	-
CK-900-60-S	CK-900-S	900x600x850	900x700x850	-	-

WTFC

NEW PRODUCT



TEKNİK DETAYLAR / TECHNICAL DETAILS

TR

- Kesme tahtası dahil alet dolabı
- Kırmızı renk
- Yuvarlatılmış köşeler
- İdeal çalışma yüksekliği
- Çok yüksek yük kapasitesi
- Alt ve ara raf
- Yavaş kapanan/açılan kapı sistemi
- Temizlemesi kolay
- Kesme plakası kalınlığı: 40 mm
- MDF Omega ile güçlendirilmiş tezgah
- Çift cidarlı paslanmaz çelik tezgah

EN

- Tool cabinet incl. Cutting board
- Red colour in standart production
- Rounded corners
- Ideal working height
- Very high load capacity
- Bottom and intermediate shelf
- Soft close/open system of door
- Easy to clean
- Cutting plate thickness: 40 mm
- Worktop reinforced with MDF Omega
- Double-walled stainless steel worktop

KOD CODE		 (MM)		€	
700 SL	700 SR	700 SL	700 SR	700 SL	700 SR
WTFC-1407085SL	WTFC-1407085SR	1400x700x850	1400x700x850	-	-
WTFC-1607085SL	WTFC-1607085SR	1600x700x850	1600x700x850	-	-
WTFC-1807085SL	WTFC-1807085SR	1800x700x850	1800x700x850	-	-
WTFC-2007085SL	WTFC-2007085SR	2000x700x850	2000x700x850	-	-



POLİETİLEN ÇALIŞMA TEZGAHI - SÜRGÜLÜ KAPILAR POLYETHYLENE WORKTABLE - WITH SLIDING DOORS

WTFS

NEW PRODUCT



TEKNİK DETAYLAR / TECHNICAL DETAILS

TR

- Kesme tahtası dahil alet dolabı
- Kırmızı renk
- Yuvarlatılmış köşeler
- İdeal çalışma yüksekliği
- Çok yüksek yük kapasitesi
- Alt ve ara raf
- Yavaş kapanan/açılan kapı sistemi
- Temizlemesi kolay
- Kesme plakası kalınlığı: 40 mm
- MDF Omega ile güçlendirilmiş tezgah
- Çift cidarlı paslanmaz çelik tezgah

EN

- Tool cabinet incl. Cutting board
- Red colour in standart production
- Rounded corners
- Ideal working height
- Very high load capacity
- Bottom and intermediate shelf
- Soft close/open system of door
- Easy to clean
- Cutting plate thickness: 40 mm
- Worktop reinforced with MDF Omega
- Double-walled stainless steel worktop



KOD CODE		 (MM)		€	
600 MM	700 MM	600 MM	700 MM	600 MM	700 MM
WTFS-1006085	WTFS-1007085	1000x600x850	1000x700x850	-	-
WTFS-1206085	WTFS-1207085	1200x600x850	1200x700x850	-	-
WTFS-1406085	WTFS-1407085	1400x600x850	1400x700x850	-	-
WTFS-1506085	WTFS-1507085	1500x600x850	1500x700x850	-	-
WTFS-1606085	WTFS-1607085	1600x600x850	1600x700x850	-	-
WTFS-1806085	WTFS-1807085	1800x600x850	1800x700x850	-	-
WTFS-2006085	WTFS-2007085	2000x600x850	2000x700x850	-	-

POLİETİLEN ÇALIŞMA TEZGAHI - ALT RAF (KAYNAKLI)
POLYETHYLENE WORKTABLE - BOTTOM SHELF (WELDED)

WTFP

NEW PRODUCT



TEKNİK DETAYLAR / TECHNICAL DETAILS

TR

- Kesme tahtası dahil alet dolabı
- Kırmızı renk
- Yuvarlatılmış köşeler
- İdeal çalışma yüksekliği
- Çok yüksek yük kapasitesi
- Alt ve ara raf
- Yavaş kapanan/açılan kapı sistemi
- Temizlemesi kolay
- Kesme plakası kalınlığı: 40 mm
- MDF Omega ile güçlendirilmiş tezgah
- Çift cidarlı paslanmaz çelik tezgah

EN

- Tool cabinet incl. Cutting board
- Red colour in standart production
- Rounded corners
- Ideal working height
- Very high load capacity
- Bottom and intermediate shelf
- Soft close/open system of door
- Easy to clean
- Cutting plate thickness: 40 mm
- Worktop reinforced with MDF Omega
- Double-walled stainless steel worktop



KOD CODE		 (MM)		€	
600 MM	700 MM	600 MM	700 MM	600 MM	700 MM
WTFP-100608	WTFP-100708	1000x600x850	1000x700x850	-	-
WTFP-1206085	WTFP-1207085	1200x600x850	1200x700x850	-	-
WTFP-1406085	WTFP-1407085	1400x600x850	1400x700x850	-	-
WTFP-1506085	WTFP-1507085	1500x600x850	1500x700x850	-	-
WTFP-1606085	WTFP-1607085	1600x600x850	1600x700x850	-	-
WTFP-1806085	WTFP-1807085	1800x600x850	1800x700x850	-	-
WTFP-2006085	WTFP-2007085	2000x600x850	2000x700x850	-	-

POLİETİLEN - ET KÜTÜĞÜ POLYETHYLENE - CHOPPING BLOCK

CB

NEW PRODUCT

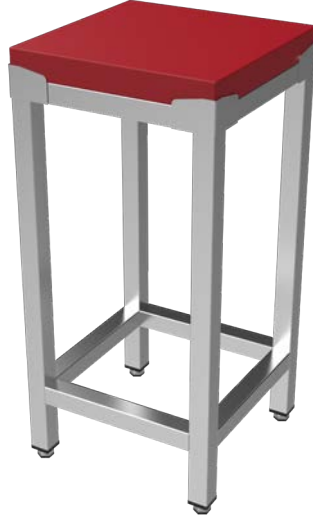

TEKNİK DETAYLAR / TECHNICAL DETAILS

TR

- Kesme tahtası dahil alet dolabı
- Kırmızı renk
- Yuvarlatılmış köşeler
- İdeal çalışma yüksekliği
- Çok yüksek yük kapasitesi
- Temizlemesi kolay
- Kesme plakası kalınlığı: 100 mm

EN

- Tool cabinet incl. Cutting board
- Red colour in standart production
- Rounded corners
- Ideal working height
- Very high load capacity
- Easy to clean
- Cutting plate thickness: 100 mm

KOD CODE	 (MM)	€
CB4004	400x400x850	-
CB5006	500x600x850	-
CB8006	800x600x850	-
CB4007	700x700x850	-
CB8008	800x800x850	-

WA-S



TEKNİK DETAYLAR / TECHNICAL DETAILS

TR

- Paslanmaz Çelik AISI 430'dan üretilmiştir
- Kaynaklı yapı
- Entegre kulplu sürgülü kapılar
- 25 kg yük kapasitesi
- Orta raf içerir

EN

- Brushed structure stainless steel AISI 430
- Welded construction
- Sliding doors with integrated handle
- 25 KG load capacity
- Including middle shelf

KOD CODE	 [MM]	€
400 MM	400 MM	400 MM
WA-1004066-S	1000x400x660	-
WA-1204066-S	1200x400x660	-
WA-1404066-S	1400x400x660	-
WA-1504066-S	1500x400x660	-
WA-1604066-S	1600x400x660	-
WA-1804066-S	1800x400x660	-
WA-2004066-S	2000x400x660	-

DUVAR DOLAPLARI - AÇIK WALL CUPBOARD - OPEN

WA

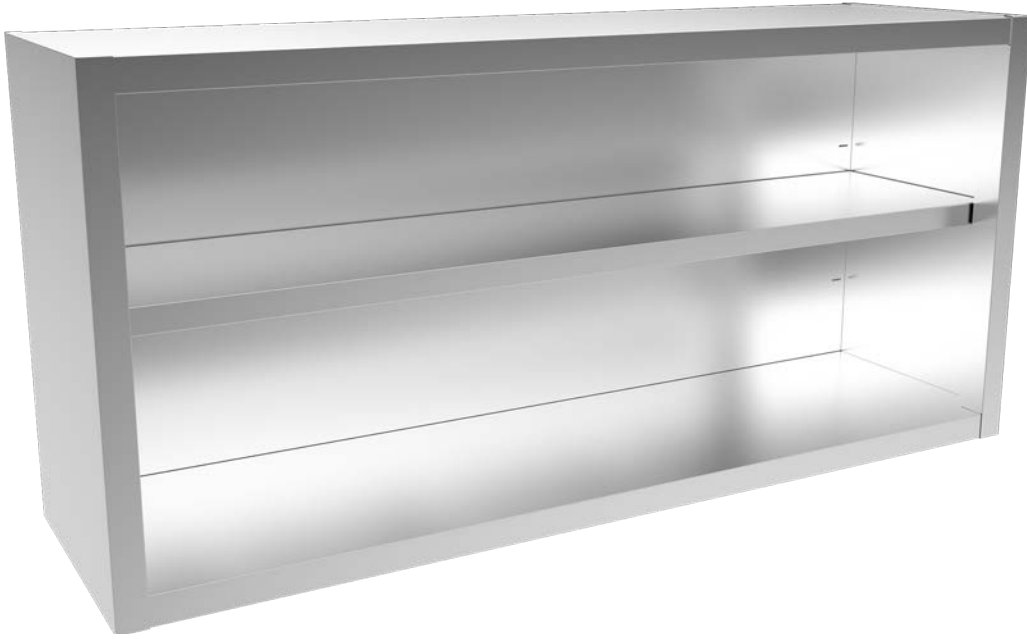

TEKNİK DETAYLAR / TECHNICAL DETAILS

TR

- Paslanmaz Çelik AISI 430'dan üretilmiştir
- Kaynaklı yapı
- Açık sürüm
- 25 kg yük kapasitesi
- Orta raf içerir

EN

- Brushed structure stainless steel AISI 430
- Welded construction
- Open version
- 25KG load capacity
- Including middle shelf

KOD CODE	 (MM)	€
400 MM	400 MM	400 MM
WA-1004066	1000x400x660	-
WA-1204066	1200x400x660	-
WA-1404066	1400x400x660	-
WA-1504066	1500x400x660	-
WA-1604066	1600x400x660	-
WA-1804066	1800x400x660	-
WA-2004066	2000x400x660	-

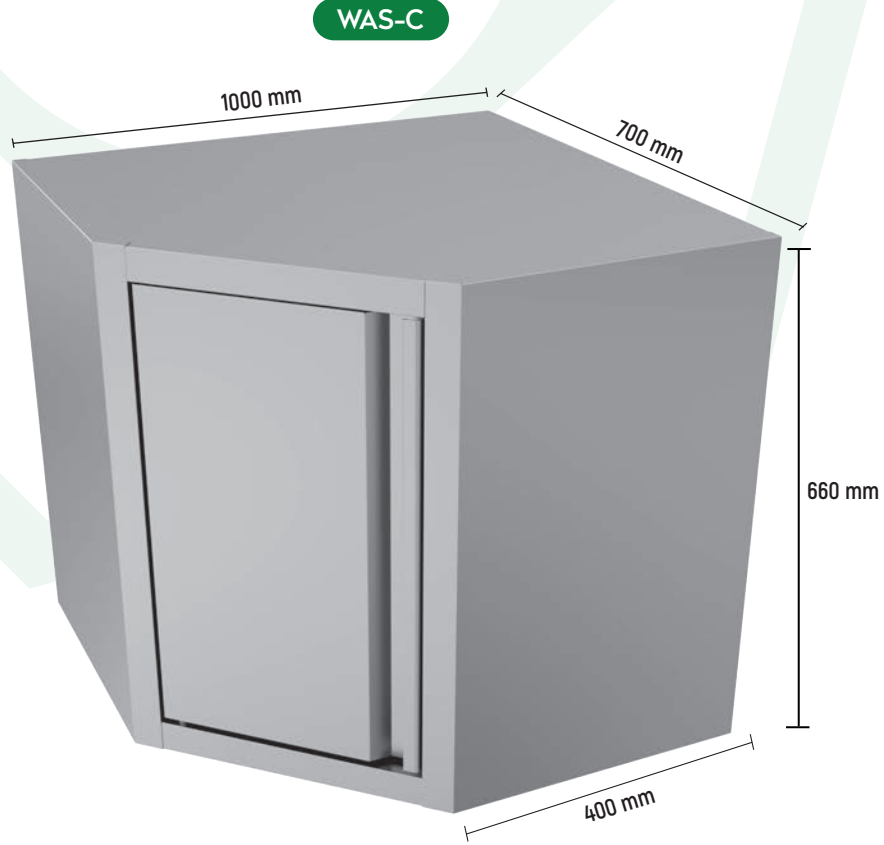

TEKNİK DETAYLAR / TECHNICAL DETAILS

TR

- Paslanmaz Çelik AISI 430'dan üretilmiştir
- Kaynaklı yapı
- Yumuşak açma/kapama mekanizmalı kapı
- 90°
- Orta raf içerir
- WA tipi dolaplarla kullanılabilir

EN

- Brushed structure stainless steel AISI 430
- Welded construction
- Door with soft open/close mechanism
- 90°
- Including middle shelf
- Usable with WA -type cupboards

KOD CODE	 [MM]	€
700 MM	700 MM	700 MM
WAS-707066-C	700x700x660	-

DUVAR DOLAPLARI - KAPAKSIZ WALL CUPBOARD - OPEN DOOR

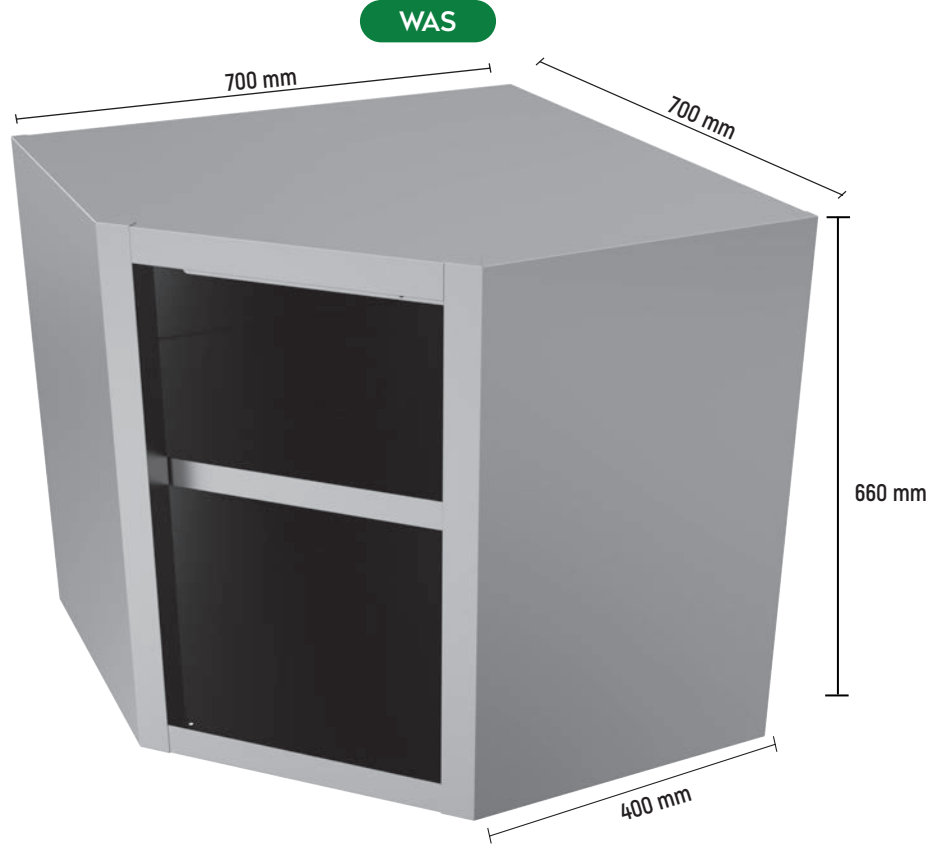

TEKNİK DETAYLAR / TECHNICAL DETAILS

TR

- Paslanmaz Çelik AISI 430'dan üretilmiştir
- Kaynaklı yapı
- Açık sürüm
- 25 kg yük kapasitesi
- Orta raf içerir

EN

- Brushed structure stainless steel AISI 430
- Welded construction
- Open version
- Including middle shelf
- Usable with WA -type cupboards

KOD CODE	 (MM)	€
700 MM	700 MM	700 MM
WAS-707066	700x700x660	-

ET-A

ET-2A

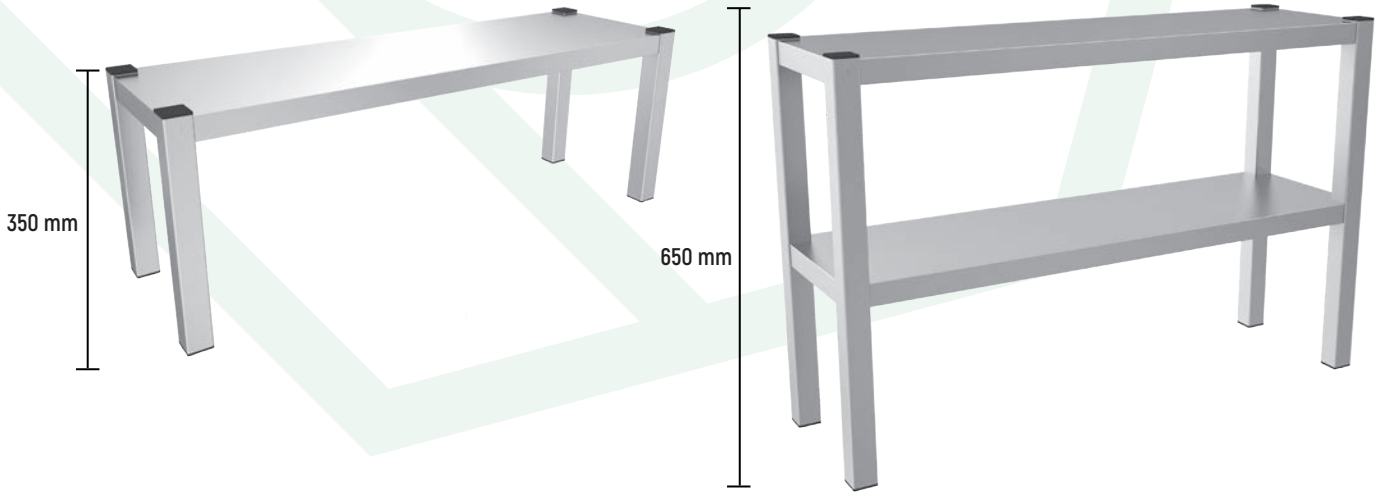

TEKNİK DETAYLAR / TECHNICAL DETAILS

TR

- Paslanmaz Çelik AISI 430'dan üretilmiştir
- Kolay kurulum imkanı
- Yüksek yükleme kapasitesi
- SH veya HH seri ısıtmalı ısıtıcı takılabilir

EN

- Made of brushed stainless steel AISI 430
- Self Assembly
- High loading capacity
- Can be fitted with the SH or HH serieheated warmer

KOD CODE		 (MM)	€	
A	2A		A	2A
ET-1003035-A	ET-1003035-2A	1000x300	-	-
ET-1203035-A	ET-1203035-2A	1200x300	-	-
ET-1403035-A	ET-1403035-2A	1400x300	-	-
ET-1603035-A	ET-1603035-2A	1600x300	-	-
ET-1803035-A	ET-1803035-2A	1800x300	-	-
ET-2003035-A	ET-2003035-2A	2000x300	-	-

ETAJERLER İÇİN ISITICILAR HEATERS FOR ETAGERE



TEKNİK DETAYLAR / TECHNICAL DETAILS

TR

- Paslanmaz Çelik AISI 430'dan üretilmiştir
- Halojen veya seramik ısıtma elemanı
- Mükemmel ısı dağılımı
- Kolay kurulum
- Açma kapama anahtarı 230V
- ET modelleri ile kullanılabilir

EN

- Made of brushed stainless steel AISI 430
- Halogeen or ceramic warming element
- Excellent heat distribution
- Handy installation
- On off switch 230V
- Usable with the ET models

KOD CODE		 (MM)	€	
HH	SH		HH	SH
ET-100-HH	ET-100-SH	1000x300	-	-
ET-120-HH	ET-120-SH	1200x300	-	-
ET-140-HH	ET-140-SH	1400x300	-	-
ET-160-HH	ET-160-SH	1600x300	-	-
ET-180-HH	ET-180-SH	1800x300	-	-
ET-200-HH	ET-200-SH	2000x300	-	-

4 KATLI RAF
4 LAYERS SHELF

SU-4



TEKNİK DETAYLAR / TECHNICAL DETAILS

TR

- Paslanmaz Çelik AISI 430'dan üretilmiştir
- Tabletlerle güçlendirilmiş 4 raf yüzeyi
- Kendiliğinden kurulma
- Yüksek yükleme kapasitesi
- Yüksekliği ayarlanabilir
- Kare profil 40 x 40 mm

EN

- Made of brushed stainless steel AISI 430
- 4 shelves surface reinforced with tablets
- Self Assembly
- High loading capacity
- Adjustable in height
- Square profile 40 x 40 mm

KOD CODE	 [MM]	€
SU-10040-4	1000x400x1800	-
SU-12040-4	1200x400x1800	-
SU-14040-4	1400x400x1800	-
SU-15040-4	1500x400x1800	-
SU-16040-4	1600x400x1800	-
SU-18040-4	1800x400x1800	-
SU-20040-4	2000x400x1800	-

DUVAR RAFI - DEMONTE WALLSHELF - FLAT PACKED



TEKNİK DETAYLAR / TECHNICAL DETAILS

TR

- Paslanmaz Çelik AISI 430'dan üretilmiştir
- Duvar konsolu içerir
- Çeşitli yüksekliklerde ayarlanabilir
- Kat başına 35 kg'a kadar yük kapasitesi

EN

- Brushed structure stainless steel AISI 430
- Includes wall console
- Adjustable in several heights
- Load capacity up to 35 kg per floor

300 KOD CODE				€		
WS-A	WS-2A	WS-3A		(MM)	WS-A	WS-2A
WS-803036-A	WS-803070-2A	WS-8030100-3A	800x300	-	-	-
WS-1003036-A	WS-1003070-2A	WS-10030100-3A	1000x300	-	-	-
WS-1203036-A	WS-1203070-2A	WS-12030100-3A	1200x300	-	-	-
WS-1403036-A	WS-1403070-2A	WS-14030100-3A	1400x300	-	-	-
WS-1603036-A	WS-1603070-2A	WS-16030100-3A	1600x300	-	-	-
WS-1803036-A	WS-1803070-2A	WS-18030100-3A	1800x300	-	-	-
WS-2003036-A	WS-2003070-2A	WS-20030100-3A	2000x300	-	-	-

400 KOD CODE				€		
WS-A	WS-2A	WS-3A		(MM)	WS-A	WS-2A
WS-804036-A	WS-804070-2A	WS-8040100-3A	800x400	-	-	-
WS-1004036-A	WS-1004070-2A	WS-10040100-3A	1000x400	-	-	-
WS-1204036-A	WS-1204070-2A	WS-12040100-3A	1200x400	-	-	-
WS-1404036-A	WS-1404070-2A	WS-14040100-3A	1400x400	-	-	-
WS-1604036-A	WS-1604070-2A	WS-16040100-3A	1600x400	-	-	-
WS-1804036-A	WS-1804070-2A	WS-18040100-3A	1800x400	-	-	-
WS-2004036-A	WS-2004070-2A	WS-20040100-3A	2000x400	-	-	-

PC



TEKNİK DETAYLAR / TECHNICAL DETAILS

TR

- Paslanmaz Çelik AISI 430'dan üretilmiştir
- Sağlam çıkarılabilir raflar
- Raf yüksekliği ayarlanabilir
- Paslanmaz çelik ayarlanabilir ayaklar
- Sürgülü kapılar
- Sürgülü kapılar için entegre kulp

EN

- Brushed structure stainless steel AISI 430
- Sturdy removable shelves
- Shelves height adjustable
- Stainless steel adjustable feet
- Sliding doors
- Integrated handle for sliding doors

KOD CODE	 (MM)	€
PC-12060180	1200x600x1800	-
PC-16060180	1600x600x1800	-

FIRIN ALT STANDI STAND FOR OVEN

CS



TEKNİK DETAYLAR / TECHNICAL DETAILS

TR

- Paslanmaz çelik AISI 430
- Kaynaklı yapı
- Kombi buharlı fırın için özel sağlam tasarım
- Kapasite 8 x 1/1GN (325x530mm)
- Farklı yüksekliklerde ayarlanabilir ayaklar
- Yüksek taşıma kapasitesi

EN

- Stainless steel AISI 430
- Welded construction
- Special robust design for combi steamer
- Capacity 8 x 1/1GN (325x530mm)
- Adjustable feet in different heights
- High load-bearing capacity

KOD CODE	 (MM)	€
CS-700	900x800x700	-
CS-900	900x800x900	-

DT

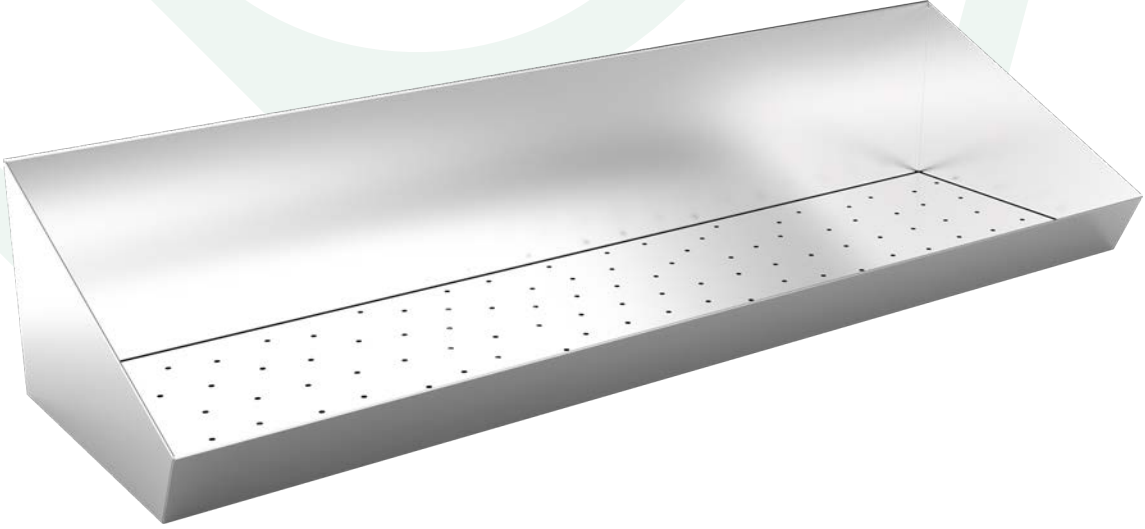

TEKNİK DETAYLAR / TECHNICAL DETAILS

TR

- Paslanmaz Çelik AISI 430'dan üretilmiştir
- Kaynaklı yapı
- Duvar askılı aksesuar ile

EN

- Brushed structure stainless steel AISI 430
- Welded construction
- Accessory with wall bracket

KOD CODE	 [MM]	€
DT-60	600x300x200	-
DT-70	700x300x200	-
DT-80	800x300x200	-
DT-90	900x300x200	-
DT-100	1000x300x200	-
DT-120	1200x300x200	-
DT-140	1400x300x200	-
DT-150	1500x300x200	-

PASLANMAZ ÇELİK ÇÖP KOVASI STAINLESS STEEL WASTEBIN

NEW PRODUCT

TC-1



TC-2



TC-3



TEKNİK DETAYLAR / TECHNICAL DETAILS

TR

- Paslanmaz Çelik AISI 430'dan üretilmiştir
- Devirme valfi ile açma
- 2 arka tekerlekli ayarlanabilir ön ayaklar

EN

- Made of brushed stainless steel AISI 430.
- Opening with tilting valve
- Adjustable front legs with 2 rear wheels

KOD CODE	 (MM)	€
TC-1 - 50L	500x400x940	-
TC-2 - 90L	500x400x1270	-
TC-3 - 80L	470x470x1250	-

FİNCAN ISITICI
CUP WARMER

KL-20

NEW PRODUCT



TEKNİK DETAYLAR / TECHNICAL DETAILS

TR

- Fincan ısıtıcısı
- Kolay kullanım
- Çalışma sıcaklığı 75 °C
- Isıtma süresi yaklaşık 3 dakika
- 2 ısıtma seviyesi
- Her ısıtma seviyesinde açma/kapama düğmesi
- Kolay temizlenebilir
- İki ısıtma seviyesi
- Bir yedek raf
- Kapasite: ca. 80 - 120 bardak
- Elektrik bağlantısı: 1 / N / PE 230 Volt / 50 Hz
- Güç: 140 watt
- Dış boyutlar G x D x Y: 320 x 340 x 550 mm

EN

- Cup heater
- Easy to use
- Operating temperature 75 °C
- Heating time approx. 3 minutes
- 2 heating levels
- On/off switch for each heating element
- Easy to clean
- Two heating levels
- One reserve shelf
- Holding capacity: ca. 80 - 120 Cups
- Electrical connection: 1 / N / PE 230 volts / 50 Hz
- Power: 140 watts
- Outer dimensions W x D x H: 320 x 340 x 550 mm

KOD CODE



320x340x550



KL-20

-

TABAK ISITICI 1 KAPILI PLATE WARMER 1 DOOR

BWH-10



NEW PRODUCT

TEKNİK DETAYLAR / TECHNICAL DETAILS

TR

- Daha iyi ısı dağılımı için dahili fanlı paslanmaz çelikten tabak ısıtma kabini. 32 Cm çapında yaklaşık 45 ila 60 tabak için uygundur, sıcaklık 30 ila 85 derece arasında ayarlanabilir.
- Kapasite: 32 cm çapında 45 - 60 tabak
- Sıcaklık aralığı: 30 ila 85 derece
- Bağlantı değeri: 230 volt, 0.8kw
- Ağırlık: 28 kg

EN

- Plate warming cabinet made of stainless steel with internal fan for better heat distribution. Suitable for approximately 45 to 60 plates with a diameter of 32 centimeters, the temperature is adjustable between 30 and 85 degrees.
- Capacity: 45 - 60 plates with a diameter of 32 centimeters
- Temperature range: 30 to 85 degrees
- Connection value: 230 volt, 0.8kw
- Weight: 28 kilos

KOD CODE



(MM)



BWH-10

450x485x850

-

BWH-20

NEW PRODUCT



TEKNİK DETAYLAR / TECHNICAL DETAILS

TR

- Daha iyi ısı dağılımı için dahili fanlı paslanmaz çelikten tabak ısıtma kabini. 32 Cm çapında yaklaşık 90 ila 120 tabak için uygundur, sıcaklık 30 ila 85 derece arasında ayarlanabilir.
- Kapasite: 32 cm çapında 90 - 120 tabak
- Bağlantı değeri: 230 volt, 1,2kw
- Ağırlık: 39 kilo

EN

- Plate warming cabinet made of stainless steel with internal fan for better heat distribution. Suitable for approximately 90 to 120 plates with a diameter of 32 centimeters, the temperature is adjustable between 30 and 85 degrees.
- Capacity: 90 - 120 plates with a diameter of 32 centimeters
- Connection value: 230 volt, 1,2kw
- Weight: 39 kilos

KOD CODE

BWH-20



750x485x850



-

EVYELİ ÇALIŞMA TEZGAHI - ÇARPMA KAPAK SINK WITH SWING DOORS

SCK







TEKNİK DETAYLAR / TECHNICAL DETAILS

TR

- Entegre kulplu sürgülü kapılar
- Ayaklı
- AISI 304 üst tabla
- Evye boyutları mm cinsinden (BxExY):500x500x300
- Yüksekliği ayarlanabilen paslanmaz çelik ayaklar

EN

- Swing doors with integrated handle
- With upstand
- AISI 304 top
- Bowl dimensions in mm (BxDxH): 500x500x300
- Stainless steel legs adjustable in height

KOD CODE	 (MM)	SINK SIDE	€
SCK-60-70	600x700x850		-
SCK-70-70	700x700x850		-
SCK-80-70	800x700x850		-

LAVABO - DÜZ PAKETLİ
SINK - FLAT PACKED

STF -L/-R







TEKNİK DETAYLAR / TECHNICAL DETAILS



TR













- Entegre kulplu kanatlı kapılar
- AISI 304 üst tabla
- Ayaklı
- Evye boyutları mm (BxExY): 500x500x300
- Yüksekliği ayarlanabilen paslanmaz çelik ayaklar

EN

- Swing doors with integrated handle
- AISI 304 top
- With upstand
- Bowl dimensions in mm (BxDxH): 500x500x300
- Stainless steel legs adjustable in height

KOD CODE	 (MM)	SINK SIDE	€
STF-607085-1	600x700x850		-
STF-707085-1	700x700x850		-
STF-807085-1	800x700x850		-

KOD CODE	 (MM)	SINK SIDE	€
STF-2007085-2M	2000x700x850		-

KOD CODE		 (MM)	SINK SIDE		€
700-L	700-R		700-L	700-R	
STF-1007085-1 L	STF-1007085-1 R	1000x700x850			-
STF-1207085-1 L	STF-1207085-1 R	1200x700x850			-
STF-1407085-1 L	STF-1407085-1 R	1400x700x850			-
STF-1607085-2 L	STF-1607085-2 R	1600x700x850			-
STF-1807085-2 L	STF-1807085-2 R	1800x700x850			-
STF-2007085-2 L	STF-2007085-2 R	2000x700x850			-

EYVELİ TEZGAHLAR - SÜRGÜ KAPAKLI SINK WITH SLIDING DOORS

ST -LS/-RS





TEKNİK DETAYLAR / TECHNICAL DETAILS













TR

- Entegre kulplu sürgülü kapılar
- Ayaklı
- AISI 304 üst tabla
- Evye mm cinsinden (BxExY):500x500x300
- Yüksekliği ayarlanabilen paslanmaz çelik ayaklar

EN

- Sliding doors with integrated handle
- With upstand
- AISI 304 top
- Bowl dimensions in mm (Bx DxH):500x500x300
- Stainless steel legs adjustable in height

KOD CODE	 (MM)	SINK SIDE	€
ST-2007085-2MS	2000x700x850		-

KOD CODE		 (MM)	SINK SIDE		€
700-L	700-R		700-L	700-R	
ST-1007085-1LS	ST-1007085-1RS	1000x700x850			-
ST-1207085-1LS	ST-1207085-1RS	1200x700x850			-
ST-1407085-1LS	ST-1407085-1RS	1400x700x850			-
ST-1607085-2LS	ST-1607085-2RS	1600x700x850			-
ST-1807085-2LS	ST-1807085-2RS	1800x700x850			-
ST-2007085-2LS	ST-2007085-2RS	2000x700x850			-

SWS













TEKNİK DETAYLAR / TECHNICAL DETAILS

TR

- Entegre kulplu sürgülü kapılar
- Bulaşık makinesi için yer ile
- AISI 304 üst tabla
- Ayaklı
- Evye boyutları mm (BxExY): 500x500x300
- Yüksekliği ayarlanabilen paslanmaz çelik ayaklar

EN

- Sliding doors with integrated handle
- With space for Dishwasher
- AISI 304 top
- With upstand
- Bowl dimensions in mm (BxDxH): 500x500x300
- Stainless steel legs adjustable in height

KOD CODE		 (MM)	SINK SIDE		€
700-L	700-R		700-L	700-R	
SWS-1207085-1LS	SWS-1207085-1RS	1200x700x850			-
SWS-1407085-1LS	SWS-1407085-1RS	1400x700x850			-
SW5-1607085-2LS	SWS-1607085-2RS	1600x700x850			-
SWS-1807085-2LS	SWS-1807085-2RS	1800x700x850			-
SWS-2007085-2LS	SWS-2007085-2RS	2000x700x850			-

EVYELİ ÇALIŞMA TEZGAHI - KAYNAKLI SINK WITH DISHWASHER SPACE - WELDED

SWF













TEKNİK DETAYLAR / TECHNICAL DETAILS

TR

- Kendinliğinden Kurulum
- Bulaşık makinesi için yer ile Raf Altı ve Ayaklı
- AISI 304 üst tabla
- Eveye boyutları mm (BxExY): 500x500x300
- Yüksekliği ayarlanabilir
- Kare profil 40 x 40 mm

EN

- With space for Dishwasher
- With undershelf & Upstand
- AISI 304 top
- Bowl dimensions in mm (BxDxH): 500x500x300
- Adjustable in height
- Square profile 40 x 40 mm

KOD CODE		 [MM]	SINK SIDE		€
700-L	700-R		700-L	700-R	
SWF-1207085-1 L	SWF-1207085-1 R	1200x700x850			-
SWF-1407085-1 L	SWF-1407085-1 R	1400x700x850			-
SWF-1607085-2 L	SWF-1607085-2 R	1600x700x850			-
SWF-1807085-2 L	SWF-1807085-2 R	1800x700x850			-
SWF-2007085-2 L	SWF-2007085-2 R	2000x700x850			-

DAVLUMBAZ
EXTRACTOR HOOD

EX 700-H

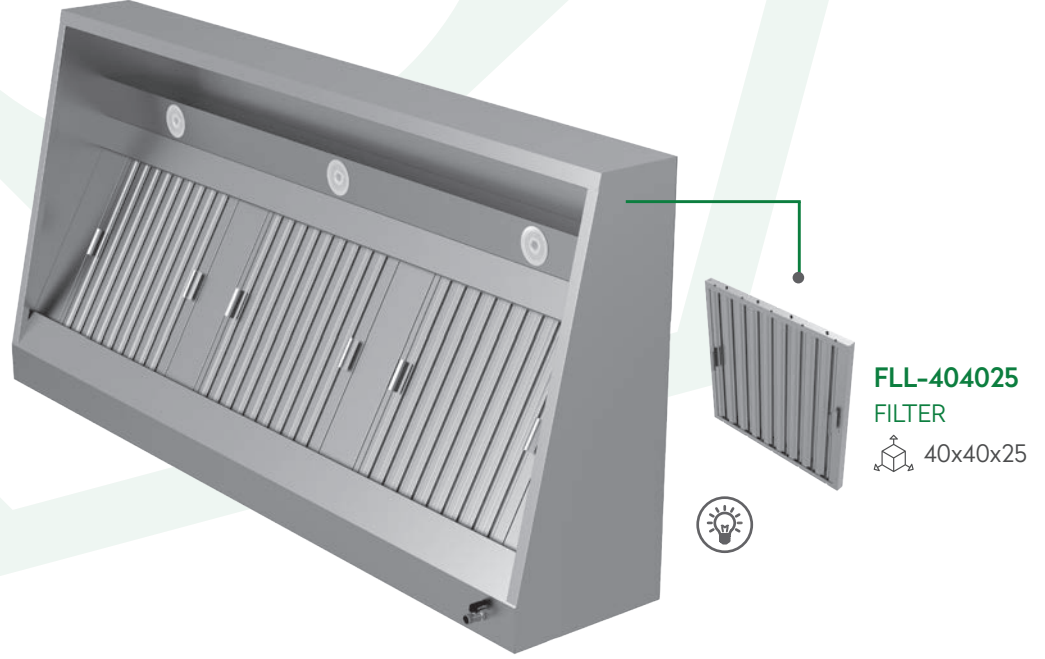
FLL-404025
FILTER
40x40x25

TEKNİK DETAYLAR / TECHNICAL DETAILS

TR

- Davlumbaz eğimlidir ve filtreler 45 derece açıyla monte edilmiştir.
- Dahili standart 5W'lı LED ışık
- Yağ tahliye valfli standart olarak üretilir.
- 400x400mm labirent filtreler dahil

EN

- Brushed structure stainless steel AISI 430
- The hood is slant and the filters are installed with an angle of 45 °
- Standard with Led Lightning 5W built-in
- Standard produced with fat drain valve
- Included Labyrinth filters 400x400 mm

KOD CODE	 [MM]	LA BYRINT FILTER	LED LIGHTS	€
EX-1007040-H	1000x700x400	2	2x5w	-
EX-1207040-H	1200x700x400	2	2x5w	-
EX-1407040-H	1400x700x400	2	2x5w	-
EX-1507040-H	1500x700x400	3	2x5w	-
EX-1607040-H	1600x700x400	3	2x5w	-
EX-1807040-H	1800x700x400	3	3x5w	-
EX-2007040-H	2000x700x400	3	3x5w	-
EX-2207040-H	2200x700x400	4	3x5w	-
EX-2407040-H	2400x700x400	4	3x5w	-
EX-2507040-H	2500x700x400	4	4x5w	-
EX-2607040-H	2600x700x400	4	4x5w	-
EX-2807040-H	2800x700x400	5	4x5w	-
EX-3007040-H	3000x700x400	5	4x5w	-
EX-3207040-H	3200x700x400	6	4x5w	-
EX-3407040-H	3400x700x400	6	5x5w	-
EX-3507040-H	3500x700x400	6	5x5w	-
EX-3607040-H	3600x700x400	7	5x5w	-
EX-3807040-H	3800x700x400	7	5x5w	-
EX-4007040-H	4000x700x400	7	5x5w	-

DAVLUMBAZ EXTRACTOR HOOD

EX 950-H

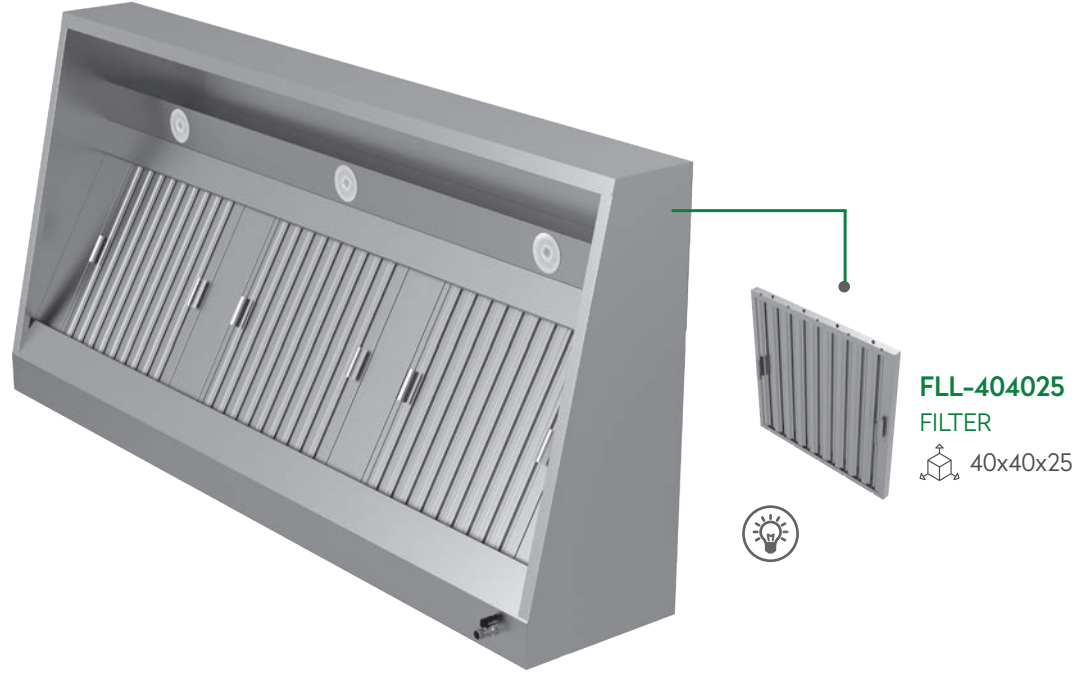

TEKNİK DETAYLAR / TECHNICAL DETAILS

TR

- Paslanmaz Çelik AISI 430'dan üretilmiştir
- Davlumbaz eğimlidir ve filtreler 45 derece açıyla monte edilmiştir.
- Dahili Standart 5W'lı LED Işık
- Yağ tahliye valfli standart olarak üretilir.
- 495x495 mm labirent filtreler dahil

EN

- Brushed structure stainless steel AISI 430
- The hood is slant and the filters are installed with an angle of 45°
- Standard with Led Lightning 5W built-in
- Standard produced with fat drain valve
- Included Labyrinth filters 495x495 mm

KOD CODE	 (MM)	LA BYRINT FILTER	LED LIGHTS	€
EX-1009540-H	1000x950x400	1	2x5w	-
EX-1209540-H	1200x950x400	2	2x5w	-
EX-1409540-H	1400x950x400	2	2x5w	-
EX-1509540-H	1500x950x400	2	2x5w	-
EX-1609540-H	1600x950x400	2	2x5w	-
EX-1809540-H	1800x950x400	3	3x5w	-
EX-2009540-H	2000x950x400	3	3x5w	-
EX-2209540-H	2200x950x400	3	3x5w	-
EX-2409540-H	2400x950x400	4	3x5w	-
EX-2509540-H	2500x950x400	4	4x5w	-
EX-2609540-H	2600x950x400	4	4x5w	-
EX-2809540-H	2800x950x400	5	4x5w	-
EX-3009540-H	3000x950x400	5	4x5w	-
EX-3209540-H	3200x950x400	5	4x5w	-
EX-3409540-H	3400x950x400	6	5x5w	-
EX-3509540-H	3500x950x400	6	5x5w	-
EX-3609540-H	3600x950x400	6	5x5w	-
EX-3809540-H	3800x950x400	6	5x5w	-
EX-4009540-H	4000x950x400	7	5x5w	-

EX 950-B

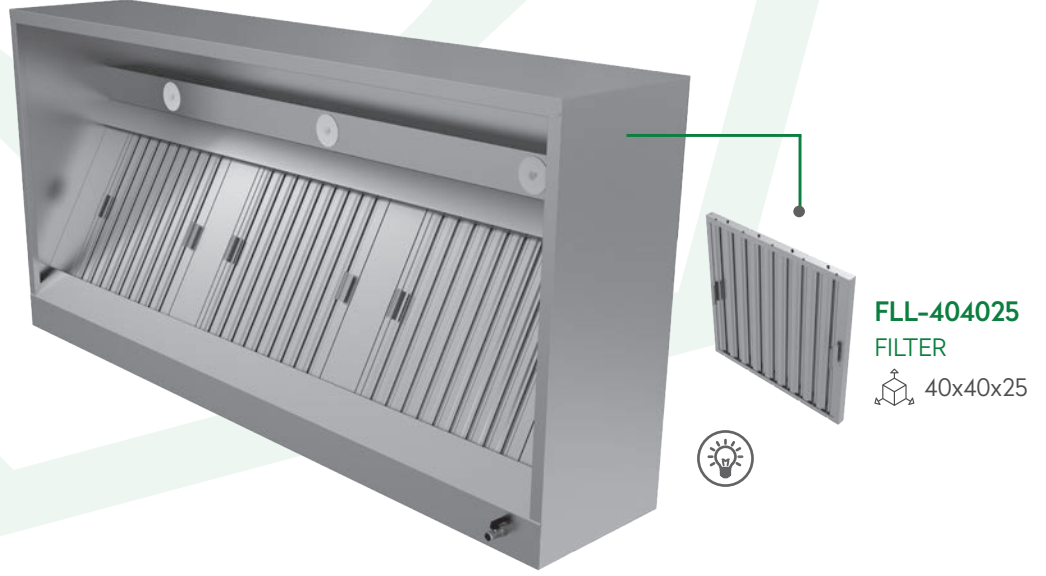

FLL-404025
FILTER
40x40x25

TEKNİK DETAYLAR / TECHNICAL DETAILS

TR

- Paslanmaz Çelik AISI 430'dan üretilmiştir
- Davlumbaz dikdörtgen şeklindedir ve filtreler 45 derece açıyla monte edilmiştir.
- Dahili standart 5W'lı LED Işık
- Yağ tahliye valfli standart olarak üretilir.
- 495 x 495 mm labirent filtreler dahil

EN

- Brushed structure stainless steel AISI 430
- The hood is rectangular and the filters are installed with an angle of 45°
- Standard with Led Lightning 5W built-in
- Standard produced with fat drain valve
- Included Labyrinth filters 495 x 495 mm

KOD CODE	 (MM)	LA BYRINT FILTER	LED LIGHTS	€
EX-1009540-B	1000x950x400	1	2x5w	-
EX-1209540-B	1200x950x400	2	2x5w	-
EX-1409540-B	1400x950x400	2	2x5w	-
EX-1509540-B	1500x950x400	2	2x5w	-
EX-1609540-B	1600x950x400	2	2x5w	-
EX-1809540-B	1800x950x400	3	3x5w	-
EX-2009540-B	2000x950x400	3	3x5w	-
EX-2209540-B	2200x950x400	3	3x5w	-
EX-2409540-B	2400x950x400	4	3x5w	-
EX-2509540-B	2500x950x400	4	4x5w	-
EX-2609540-B	2600x950x400	4	4x5w	-
EX-2809540-B	2800x950x400	5	4x5w	-
EX-3009540-B	3000x950x400	5	4x5w	-
EX-3209540-B	3200x950x400	5	4x5w	-
EX-3409540-B	3400x950x400	6	5x5w	-
EX-3509540-B	3500x950x400	6	5x5w	-
EX-3609540-B	3600x950x400	6	5x5w	-
EX-3809540-B	3800x950x400	6	5x5w	-
EX-4009540-B	4000x950x400	7	5x5w	-

AYIRICI KUTU MODELİ EXTRACTOR BOX MODEL

EX 1100-B

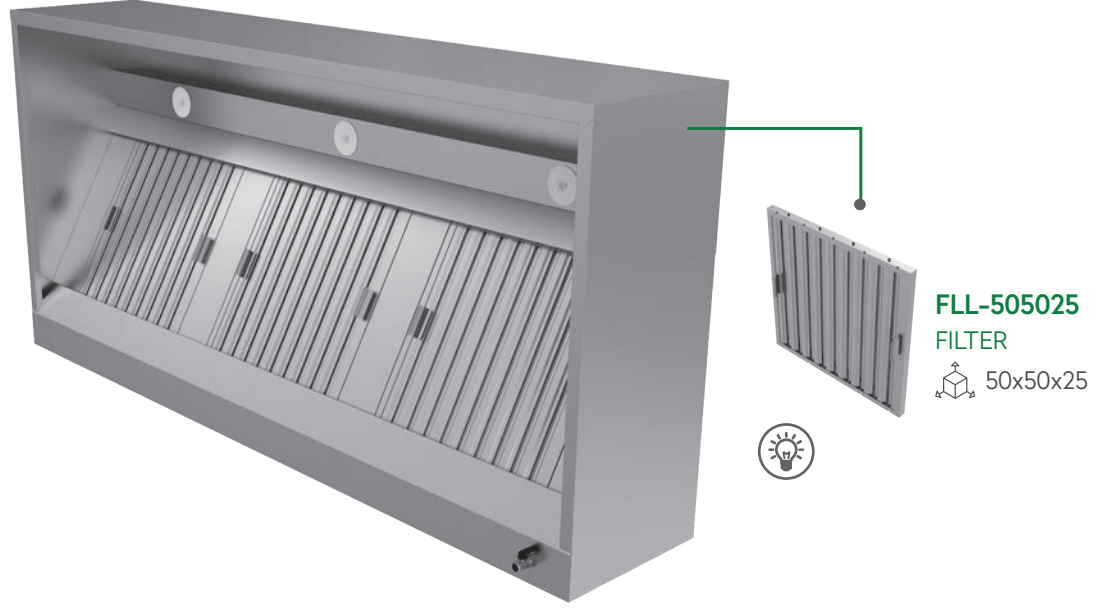

TEKNİK DETAYLAR / TECHNICAL DETAILS

TR

- Paslanmaz Çelik AISI 430'dan üretilmiştir
- Davlumbaz dikdörtgen şeklindedir ve filtreler 45 derece açıyla monte edilmiştir.
- Dahili standart 5W'lı LED Işık
- Yağ tahliye valfli standart olarak üretilir.
- 495x495 mm labirent filtreler dahil

EN

- Brushed structure stainless steel AISI 430
- The hood is rectangular and the filters are installed with an angle of 45°
- Standard with Led Lightning 5W built-in
- Standard produced with fat drain valve
- Included Labyrinth filters 495x495 mm

KOD CODE	 (MM)	LA BYRINT FILTER	LED LIGHTS	€
EX-10011040-B	1000x1100x400	1	2x5w	-
EX-12011040-B	1200x1100x400	2	2x5w	-
EX-14011040-B	1400x1100x400	2	2x5w	-
EX-15011040-B	1500x1100x400	2	2x5w	-
EX-16011040-B	1600x1100x400	2	2x5w	-
EX-18011040-B	1800x1100x400	3	3x5w	-
EX-20011040-B	2000x1100x400	3	3x5w	-
EX-22011040-B	2200x1100x400	3	3x5w	-
EX-24011040-B	2400x1100x400	4	3x5w	-
EX-25011040-B	2500x1100x400	4	4x5w	-
EX-26011040-B	2600x1100x400	4	4x5w	-
EX-28011040-B	2800x1100x400	5	4x5w	-
EX-30011040-B	3000x1100x400	5	4x5w	-
EX-32011040-B	3200x1100x400	6	4x5w	-
EX-34011040-B	3400x1100x400	6	5x5w	-
EX-35011040-B	3500x1100x400	6	5x5w	-
EX-36011040-B	3600x1100x400	7	5x5w	-
EX-38011040-B	3800x1100x400	7	5x5w	-
EX-40011040-B	4000x1100x400	7	5x5w	-

EXP 700-H

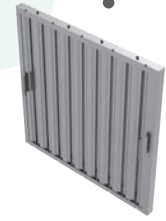
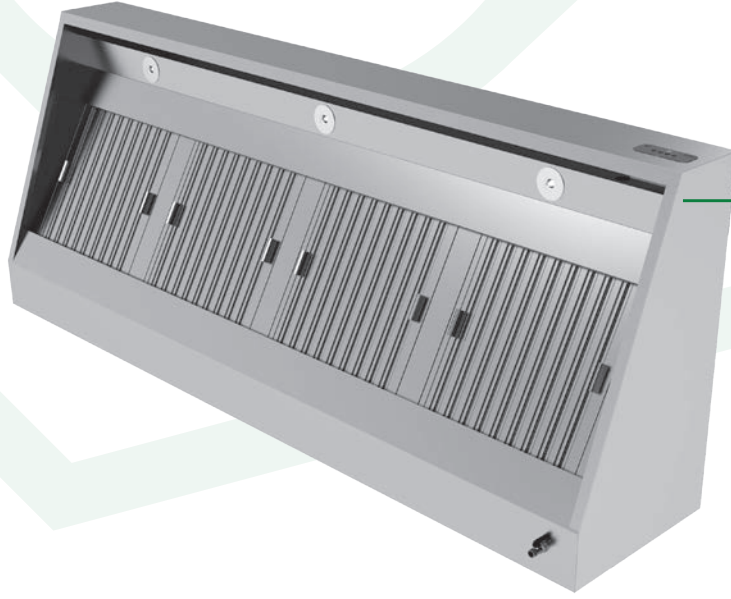

FLL-404025
FILTER
40x40x25



TEKNİK DETAYLAR / TECHNICAL DETAILS

TR

- Paslanmaz Çelik AISI 430'dan üretilmiştir
- Davlumbaz dikdörtgen şeklindedir ve filtreler 45 derece açıyla monte edilmiştir.
- Dahili standart 5W'lı LED ışık
- Yağ tahliye valfli standart olarak üretilir.
- 400x400mm labirent filtreler dahil
- Açma/Kapama ışığı ve düğmeli Açma/Kapama gaz vanası dahildir.

EN

- Brushed structure stainless steel AISI 430
- The hood is slant and the filters are installed with an angle of 45 °
- Standard with Led Lightning 5W built-in
- Standard produced with fat drain valve
- Included Labyrinth filters 400x400 mm
- Included On/Off controller with lightning & gasvalve on/off switch buttons

KOD CODE	 (MM)	LA BYRINT FILTER	LED LIGHTS	CAPACITY	€
EXP-1007054-H	1000x700x540	2	2x5w	1500m ³ /h	-
EXP-1207054-H	1200x700x540	2	2x5w	1500m ³ /h	-
EXP-1507054-H	1500x700x540	3	2x5w	1500m ³ /h	-
EXP-1607054-H	1600x700x540	3	2x5w	1500m ³ /h	-
EXP-2007054-H	2000x700x540	4	3x5w	1500m ³ /h	-
EXP-2407054-H	2400x700x540	4	3x5w	2500m ³ /h	-
EXP-2507054-H	2500x700x540	4	4x5w	2500m ³ /h	-
EXP-3007054-H	3000x700x540	5	5x5w	2500m ³ /h	-

HAVALANDIRMALI DAVLUMBAZ - MOTORLU EXTRACTOR HOOD WITH VENTILATOR - PLUG & PLAY

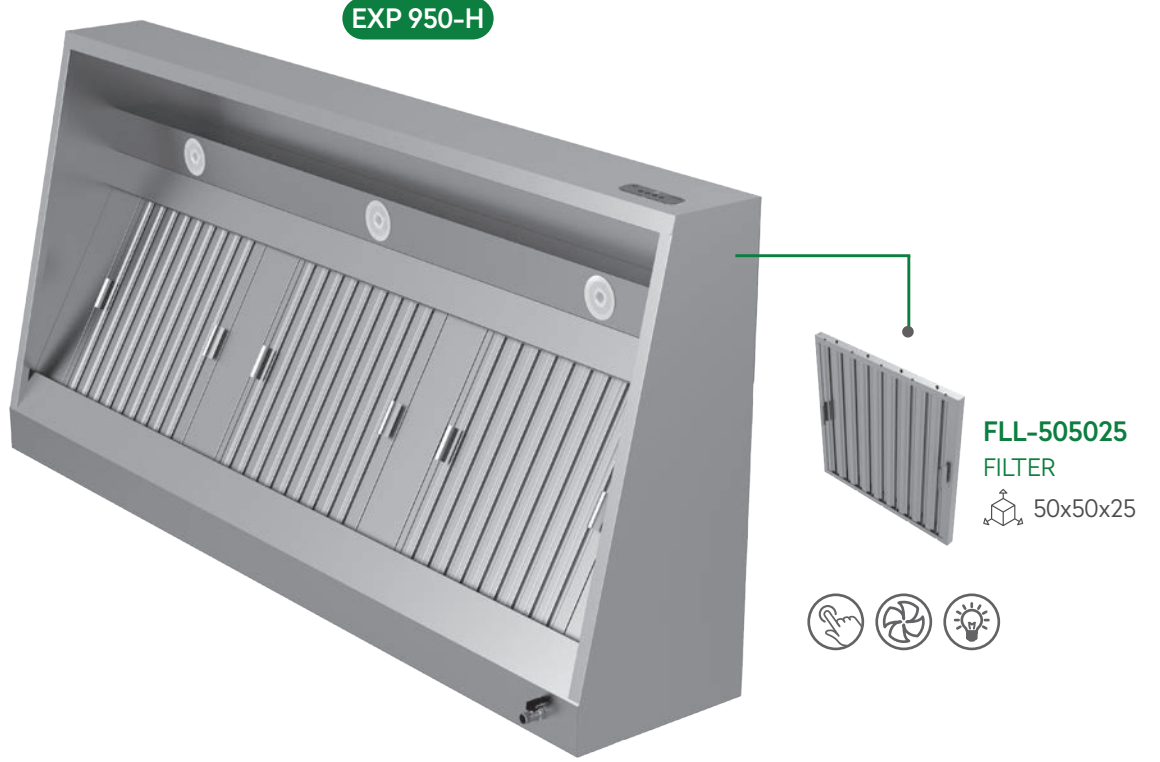

TEKNİK DETAYLAR / TECHNICAL DETAILS

TR

- Paslanmaz Çelik AISI 430'dan üretilmiştir
- Davlumbaz dikdörtgen şeklindedir ve filtreler 45 derece açıyla monte edilmiştir.
- Dahili standart 5W'lı LED Işık
- Yağ tahliye valfli standart olarak üretilir.
- 495 x 495 mm labirent filtreler dahil
- Açma/Kapama ışığı ve düğmeli Açma/Kapama gaz vanası dahildir.

EN

- Brushed structure stainless steel AISI 430
- The hood is slant and the filters are installed with an angle of 45°
- Standard with Led Lightning 5W built-in
- Standard produced with fat drain valve
- Included Labyrinth filters 495 x 495 mm
- Included On/Off controller with lightning & gasvalve on/off switch buttons

KOD CODE	 [MM]	LA BYRINT FILTER	LED LIGHTS	CAPACITY	€
EXP-1009552-H	1000x950x520	1	2x5w	1500m ³ /h	-
EXP-1209552-H	1200x950x520	2	2x5w	1500m ³ /h	-
EXP-1509552-H	1500x950x520	2	2x5w	1500m ³ /h	-
EXP-1609552-H	1600x950x520	2	2x5w	1500m ³ /h	-
EXP-2009552-H	2000x950x520	3	3x5w	1500m ³ /h	-
EXP-2409552-H	2400x950x520	4	3x5w	2500m ³ /h	-
EXP-2509552-H	2500x950x520	4	4x5w	2500m ³ /h	-
EXP-3009552-H	3000x950x520	5	5x5w	2500m ³ /h	-

EXP 950-B

FLL-505025
FILTER

50x50x25



TEKNİK DETAYLAR / TECHNICAL DETAILS

TR

- Paslanmaz Çelik AISI 430'dan üretilmiştir
- Davlumbaz dikdörtgen şeklindedir ve filtreler 45 derece açıyla monte edilmiştir.
- Dahili standart 5W'lı LED ışık
- Yağ tahliye valfli standart olarak üretilir.
- 495 x 495 mm labirent filtreler dahil
- Açma/Kapama ışığı ve düğmeli Açma/Kapama gaz vanası dahildir.

EN

- Brushed structure stainless steel AISI 430
- The hood is rectangular and the filters are installed with an angle of 45°
- Standard with Led Lightning 5W built-in
- Standard produced with fat drain valve
- Included Labyrinth filters 495 x 495 mm
- Included On/Off controller with lightning & gasvalve on/off switch buttons

KOD CODE	 (MM)	LA BYRINT FILTER	LED LIGHTS	CAPACITY	€
EXP-1009552-B	1000x950x520	1	2x5w	1500m ³ /h	-
EXP-1209552-B	1200x950x520	2	2x5w	1500m ³ /h	-
EXP-1509552-B	1500x950x520	2	2x5w	1500m ³ /h	-
EXP-1609552-B	1600x950x520	2	2x5w	1500m ³ /h	-
EXP-2009552-B	2000x950x520	3	3x5w	1500m ³ /h	-
EXP-2409552-B	2400x950x520	4	3x5w	2500m ³ /h	-
EXP-2509552-B	2500x950x520	4	4x5w	2500m ³ /h	-
EXP-3009552-B	3000x950x520	5	5x5w	2500m ³ /h	-

MERKEZİ DAVLUMBAZ MODELİ EXTRACTOR CENTRAL HOOD MODEL

EX 1500-C

EX 2000-C

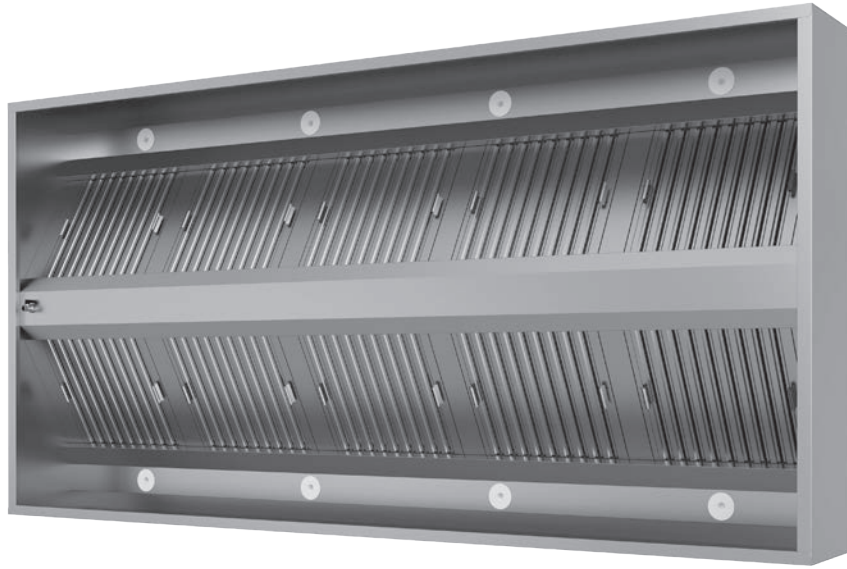

TEKNİK DETAYLAR / TECHNICAL DETAILS

TR

- Paslanmaz Çelik AISI 430'dan üretilmiştir
- Davlumbaz dikdörtgen şeklindedir ve filtreler 45 derece açıyla monte edilmiştir.
- Dahili standart 5W'lı LED Işık
- Damlatmayan, hermetik olarak kapatılmış gres toplama kanalı
- 495 x 495 mm labirent filtreler dahil

EN

- Brushed structure stainless steel AISI 430
- The hood is rectangular and the filters are installed with an angle of 45°
- Standard with Led Lightning 5W built-in
- Drip-free, hermetically sealed grease collection channel
- Included Labyrinth filters 495 x 495 mm

KOD CODE	 (MM)	LA BYRINT FILTER	LED LIGHTS	€
EX-20015040-C	2000x1500x400	2 x 3	6x5w	-
EX-25015040-C	2500x1500x400	2 x 4	8x5w	-
EX-30015040-C	3000x1500x400	2 x 5	8x5w	-
EX-35015040-C	3500x1500x400	2 x 6	10x5w	-
EX-40015040-C	4000x1500x400	2 x 7	10x5w	-
EX-45015040-C	4500x1500x400	2 x 7	12x5w	-
EX-50015040-C	5000x1500x400	2 x 8	12x5w	-

KOD CODE	 (MM)	LA BYRINT FILTER	LED LIGHTS	€
EX-20020040-C	2000x2000x400	2 x 3	6x5w	-
EX-25020040-C	2500x2000x400	2 x 4	8x5w	-
EX-30020040-C	3000x2000x400	2 x 5	8x5w	-
EX-35020040-C	3500x2000x400	2 x 6	10x5w	-
EX-40020040-C	4000x2000x400	2 x 7	10x5w	-
EX-45020040-C	4500x2000x400	2 x 7	12x5w	-
EX-50020040-C	5000x2000x400	2 x 8	12x5w	-

EXP 1300-IP

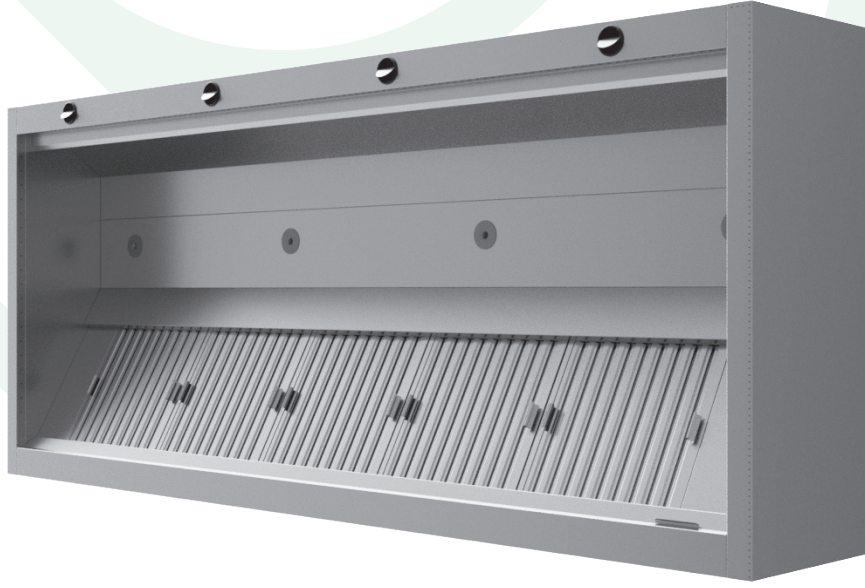

TEKNİK DETAYLAR / TECHNICAL DETAILS

TR

- Paslanmaz Çelik AISI 430'dan üretilmiştir
- Davlumbaz dikdörtgen şeklindedir ve filtreler 45 derece açıyla monte edilmiştir.
- 20mm yalıtım kalınlığı ile izole edilmiş hava verme alanı.
- Dahili standart 5W'lı LED ışık
- Damlatmayan, hermetik olarak kapatılmış gres toplama kanalı
- 495 x 495 mm labirent filtreler dahil
- Önde hava giriş valfi dahil

EN

- Brushed structure stainless steel AISI 430
- The hood is rectangular and the filters are installed with an angle of 45°
- Air supply space isolated with 20mm insulation thickness.
- Standard with Led Lightning 5W built-in
- Drip-free, hermetically sealed grease collection channel
- Included Labyrinth filters 495 x 495 mm
- Including air inlet valve at the front

KOD CODE	 (MM)	LA BYRINT FILTER	LED LIGHTS	€
EX-20013055-IP	2000x1300x550	3	3x5w	-
EX-25013055-IP	2500x1300x550	4	4x5w	-
EX-30013055-IP	3000x1300x550	5	4x5w	-
EX-35013055-IP	3500x1300x550	6	5x5w	-
EX-40013055-IP	4000x1300x550	7	5x5w	-
EX-45013055-IP	4500x1300x550	7	6x5w	-
EX-50013055-IP	5000x1300x550	8	8x5w	-

AYIRICI MERKEZİ İNDÜKSİYON MODELİ EXTRACTOR CENTRAL INDUCTION MODEL

EXP 2200-C

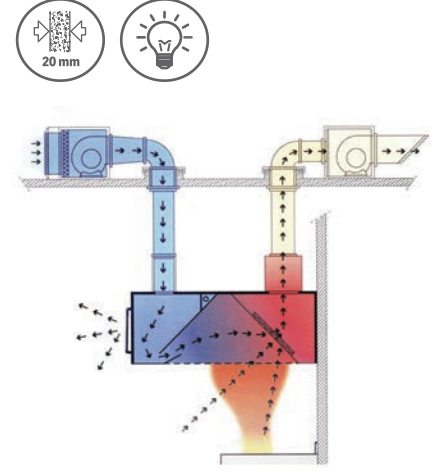
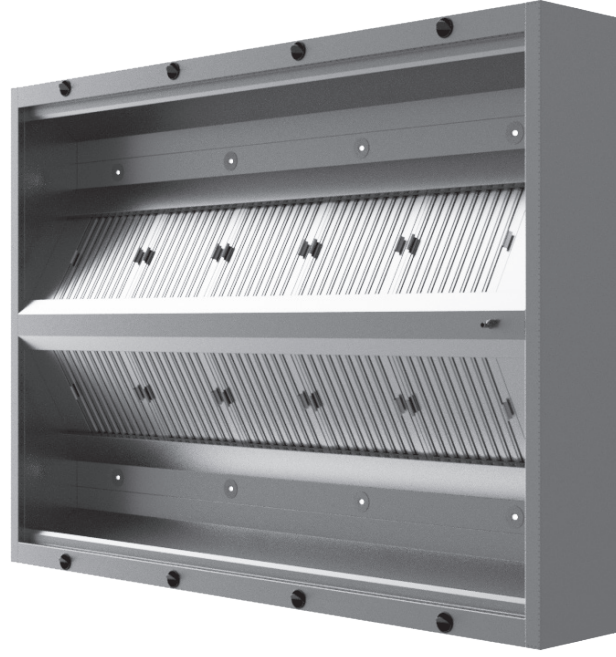

TEKNİK DETAYLAR / TECHNICAL DETAILS

TR

- Paslanmaz Çelik AISI 430'dan üretilmiştir
- Davlumbaz dikdörtgen şeklindedir ve filtreler 45 derece açıyla monte edilmiştir.
- 20mm yalıtım kalınlığı ile izole edilmiş hava verme alanı.
- Dahili standart 5W'lı LED ışık
- Damlatmayan, hermetik olarak kapatılmış gres toplama kanalı
- 495 x 495 mm labirent filtreler dahil
- Önde hava giriş valfi dahil

EN

- Brushed structure stainless steel AISI 430
- The hood is rectangular and the filters are installed with an angle of 45°
- Air supply space isolated with 20mm insulation thickness.
- Standard with Led Lightning 5W built-in
- Drip-free, hermetically sealed grease collection channel
- Included Labyrinth filters 495 x 495 mm
- Including air inletvalve at the front

KOD CODE	 (MM)	LA BYRINT FILTER	LED LIGHTS	€
EX-20022050-C	2000x2200x550	2 x 3	6x5w	-
EX-25022050-C	2500x2200x550	2 x 4	8x5w	-
EX-30022050-C	3000x2200x550	2 x 5	8x5w	-
EX-35022050-C	3500x2200x550	2 x 6	10x5w	-
EX-40022050-C	4000x2200x550	2 x 7	10x5w	-
EX-45022050-C	4500x2200x550	2 x 7	12x5w	-
EX-50022050-C	5000x2200x550	2 x 8	16x5w	-

YARDIMCI PASLANMAZ ÜRÜNLER



AUXILIARY INOX PRODUCTS



AIM

YARDIMCI NOX ÜRÜNLER AUXILIARY INOX PRODUCTS

DİZDEN KUMANDALI EVYE VE PASPAS YIKAMA EVYESİ KNEE OPERATED HANDWASH SINK AND JANITORIAL SINK

KO1**JS1**

TEKNİK DETAYLAR / TECHNICAL DETAILS

TR

- AISI-304 Paslanmaz Çelik
- Polısajlanmış yüzey
- 1" 1/2 Sifon ölçüsü
- Köşeli kenar

EN

- AISI-304 Stainless steel
- Electropolished material
- 1" 1/2 Siphon diameter
- Cornered edge

KOD CODE	 (MM)	€
AIM KO1	390x360x210	-
AIM JS1	500x600x900	-
AIM JS2	500x700x900	-



BULAŞIK TOPLAMA ARABASI SOILED DISH TROLLEY

KOD CODE	 [MM]	PASLANMAZ TİPİ S.S. TYPE	€
AIM SDT03	850x550x900	304	-



SERVİS ARABASI-İKİ KATLI SERVICE TROLLEY-2 LAYERS

KOD CODE	 [MM]	PASLANMAZ TİPİ S.S. TYPE	€
AIM ST2-3	550x860x900	304	-
AIM ST2-4	550x860x900	430	-



SERVİS ARABASI-ÜÇ KATLI SERVICE TROLLEY-3 LAYERS

KOD CODE	 [MM]	PASLANMAZ TİPİ S.S. TYPE	€
AIM ST3-3	550x860x900	304	-
AIM ST3-4	550x860x900	430	-

TAHLİYELİ TAŞIMA ARABASI
TROLLEY WITH DRAIN VALVE

KOD CODE	 [MM]	PASLANMAZ TİPİ S.S. TYPE	€
AIM TDW3	550x860x900	304	-

ÇÖP ARABASI
WASTE BIN

KOD CODE	 [MM]	PASLANMAZ TİPİ S.S. TYPE	€
AIM WB3	400400	304	-

PLATFORM ARABASI
PLATFORM TROLLEY

KOD CODE	 [MM]	PASLANMAZ TİPİ S.S. TYPE	€
AIM PT3	800x600x200/900	304	-



15 TEPŞİ KAPASİTELİ
15 TRAY CAPACITY

37x53 TEPŞİ TAŞIMA ARABASI 37x53 TRAY TROLLEY

KOD CODE	 [MM]	PASLANMAZ TİPİ S.S. TYPE	€
AIM 3753-1	430x570x1600	304	-

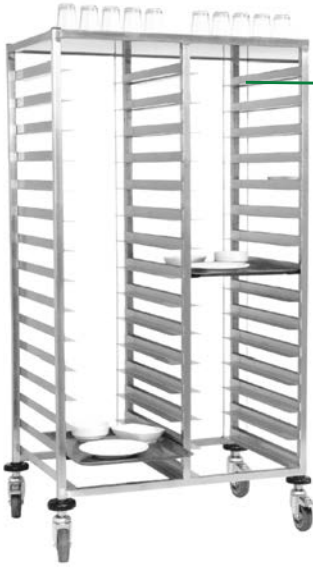

30 TEPŞİ KAPASİTELİ
30 TRAY CAPACITY

37x53 TEPŞİ TAŞIMA ARABASI - İKİLİ 37x53 TRAY TROLLEY - TWIN

KOD CODE	 [MM]	PASLANMAZ TİPİ S.S. TYPE	€
AIM 3753-2	830x570x1600	304	-

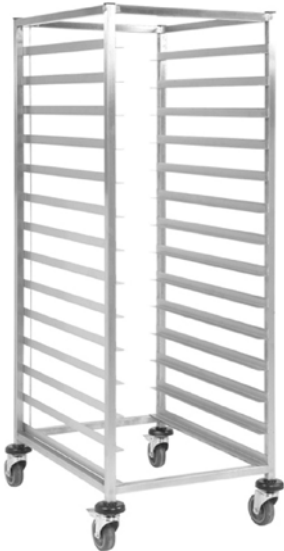

40x60 TEPŞİ TAŞIMA ARABASI 40x60 TRAY TROLLEY

KOD CODE	 [MM]	PASLANMAZ TİPİ S.S. TYPE	€
AIM 4060-1	440x630x1650	304	-

**1/1 GN TEPŞİ TAŞIMA ARABASI**
1/1 GN TROLLEY

KOD CODE	 [MM]	GN 1/1 KAPASİTESİ GN 1/1 CAPACITY	PASLANMAZ TİPİ S.S. TYPE	€
AIM 11-9	440x630x900	9	304	-
AIM 11-17	440x630x1720	17	304	-

**2/1 GN TEPŞİ TAŞIMA ARABASI**
2/1 GN TROLLEY

KOD CODE	 [MM]	GN 2/1 KAPASİTESİ GN 2/1 CAPACITY	PASLANMAZ TİPİ S.S. TYPE	€
AIM 21-9	580x660x900	9	304	-
AIM 21-17	580x660x1720	17	304	-



TABAK OTOMATI - TEKLİ PLATE DISPENSER - SINGLE

KOD CODE	 (MM)	TABAK KAPASİTE PLATE CAPACITY	MODEL TYPE	€
AIM 1826N	500x440x940	18/26	NÖTR / NEUTRAL	-
AIM 1826H	500x440x940	18/26	ISITMALI / HEATED	-
AIM 2432N	500x480x940	24/32	NÖTR / NEUTRAL	-
AIM 2432H	500x480x940	24/32	ISITMALI / HEATED	-



TABAK OTOMATI - İKİLİ PLATE DISPENSER - TWIN

KOD CODE	 (MM)	TABAK KAPASİTE PLATE CAPACITY	MODEL TYPE	€
AIM 1826N-2	720x440x940	18/26	NÖTR / NEUTRAL	-
AIM 1826H-2	720x440x940	18/26	ISITMALI / HEATED	-
AIM 2432N-2	840x480x940	24/32	NÖTR / NEUTRAL	-
AIM 2432H-2	840x480x940	24/32	ISITMALI / HEATED	-



TABAK OTOMATI - DÖRTLÜ PLATE DISPENSER - QUAD

KOD CODE	 (MM)	TABAK KAPASİTE PLATE CAPACITY	MODEL TYPE	€
AIM 1826N-4	720x440x940	18/26	NÖTR / NEUTRAL	-
AIM 1826H-4	720x440x940	18/26	ISITMALI / HEATED	-
AIM 2432N-4	840x480x940	24/32	NÖTR / NEUTRAL	-
AIM 2432H-4	840x480x940	24/32	ISITMALI / HEATED	-

AIM

YARDIMCI NOX ÜRÜNLER AUXILIARY INOX PRODUCTS

PASLANMAZ ÇELİK TEL RAFLAR STAINLESS STEEL WIRE SHELVING



AISI 304

AISI 201

KOD CODE	 (MM)	€
AIM184691-3WLS	460x910x1830	-
AIM184610-3WLS	460x1070x1830	-
AIM184612-3WLS	460x1220x1830	-
AIM184613-3WLS	460x1370x1830	-
AIM184615-3WLS	460x1520x1830	-
AIM184618-3WLS	460x1830x1830	-
AIM185391-3WLS	530x910x1830	-
AIM185310-3WLS	530x1070x1830	-
AIM185312-3WLS	530x1220x1830	-
AIM185313-3WLS	530x1370x1830	-
AIM185315-3WLS	530x1520x1830	-
AIM185318-3WLS	530x1830x1830	-
AIM186191-3WLS	610x910x1830	-
AIM186110-3WLS	610x1070x1830	-
AIM186112-3WLS	610x1220x1830	-
AIM186113-3WLS	610x1370x1830	-
AIM186115-3WLS	610x1520x1830	-
AIM186118-3WLS	610x1830x1830	-

KOD CODE	 (MM)	€
AIM184691-2WLS	460x910x1830	-
AIM184610-2WLS	460x1070x1830	-
AIM184612-2WLS	460x1220x1830	-
AIM184613-2WLS	460x1370x1830	-
AIM184615-2WLS	460x1520x1830	-
AIM184618-2WLS	460x1830x1830	-
AIM185391-2WLS	530x910x1830	-
AIM185310-2WLS	530x1070x1830	-
AIM185312-2WLS	530x1220x1830	-
AIM185313-2WLS	530x1370x1830	-
AIM185315-2WLS	530x1520x1830	-
AIM185318-2WLS	530x1830x1830	-
AIM186191-2WLS	610x910x1830	-
AIM186110-2WLS	610x1070x1830	-
AIM186112-2WLS	610x1220x1830	-
AIM186113-2WLS	610x1370x1830	-
AIM186115-2WLS	610x1520x1830	-
AIM186118-2WLS	610x1830x1830	-

PASLANMAZ ÇELİK DÜZ RAFLAR STAINLESS STEEL SOLID SHELVES



AISI 304

AISI 201

KOD CODE	 [MM]	€
AIM184691-3DS	460x910x1830	-
AIM184610-3DS	460x1070x1830	-
AIM184612-3DS	460x1220x1830	-
AIM184613-3DS	460x1370x1830	-
AIM184615-3DS	460x1520x1830	-
AIM184618-3DS	460x1830x1830	-
AIM185391-3DS	530x910x1830	-
AIM185310-3DS	530x1070x1830	-
AIM185312-3DS	530x1220x1830	-
AIM185313-3DS	530x1370x1830	-
AIM185315-3DS	530x1520x1830	-
AIM185318-3DS	530x1830x1830	-
AIM186191-3DS	610x910x1830	-
AIM186110-3DS	610x1070x1830	-
AIM186112-3DS	610x1220x1830	-
AIM186113-3DS	610x1370x1830	-
AIM186115-3DS	610x1520x1830	-
AIM186118-3DS	610x1830x1830	-

KOD CODE	 [MM]	€
AIM184691-2DS	460x910x1830	-
AIM184610-2DS	460x1070x1830	-
AIM184612-2DS	460x1220x1830	-
AIM184613-2DS	460x1370x1830	-
AIM184615-2DS	460x1520x1830	-
AIM184618-2DS	460x1830x1830	-
AIM185391-2DS	530x910x1830	-
AIM185310-2DS	530x1070x1830	-
AIM185312-2DS	530x1220x1830	-
AIM185313-2DS	530x1370x1830	-
AIM185315-2DS	530x1520x1830	-
AIM185318-2DS	530x1830x1830	-
AIM186191-2DS	610x910x1830	-
AIM186110-2DS	610x1070x1830	-
AIM186112-2DS	610x1220x1830	-
AIM186113-2DS	610x1370x1830	-
AIM186115-2DS	610x1520x1830	-
AIM186118-2DS	610x1830x1830	-

AIM

YARDIMCI NOX ÜRÜNLER AUXILIARY INOX PRODUCTS

PASLANMAZ ÇELİK DELİKLİ RAFLAR STAINLESS STEEL PERFORATED SHELVES

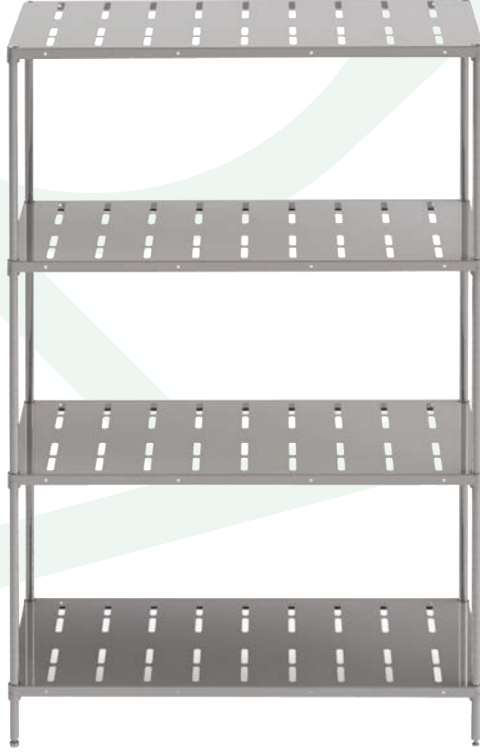
**AISI 304**



KOD CODE	 (MM)	€
AIM184691-3DD	460x910x1830	-
AIM184610-3DD	460x1070x1830	-
AIM184612-3DD	460x1220x1830	-
AIM184613-3DD	460x1370x1830	-
AIM184615-3DD	460x1520x1830	-
AIM184618-3DD	460x1830x1830	-
AIM185391-3DD	530x910x1830	-
AIM185310-3DD	530x1070x1830	-
AIM185312-3DD	530x1220x1830	-
AIM185313-3DD	530x1370x1830	-
AIM185315-3DD	530x1520x1830	-
AIM185318-3DD	530x1830x1830	-
AIM186191-3DD	610x910x1830	-
AIM186110-3DD	610x1070x1830	-
AIM186112-3DD	610x1220x1830	-
AIM186113-3DD	610x1370x1830	-
AIM186115-3DD	610x1520x1830	-
AIM186118-3DD	610x1830x1830	-

AISI 201

KOD CODE	 (MM)	€
AIM184691-2DD	460x910x1830	-
AIM184610-2DD	460x1070x1830	-
AIM184612-2DD	460x1220x1830	-
AIM184613-2DD	460x1370x1830	-
AIM184615-2DD	460x1520x1830	-
AIM184618-2DD	460x1830x1830	-
AIM185391-2DD	530x910x1830	-
AIM185310-2DD	530x1070x1830	-
AIM185312-2DD	530x1220x1830	-
AIM185313-2DD	530x1370x1830	-
AIM185315-2DD	530x1520x1830	-
AIM185318-2DD	530x1830x1830	-
AIM186191-2DD	610x910x1830	-
AIM186110-2DD	610x1070x1830	-
AIM186112-2DD	610x1220x1830	-
AIM186113-2DD	610x1370x1830	-
AIM186115-2DD	610x1520x1830	-
AIM186118-2DD	610x1830x1830	-

ALÜMİNYUM AYAKLI POLİPROPLEN RAFLAR ALUMINIUM LEGS POLYPROPYLENE SHELVING



KOD CODE	 (MM)	€	KOD CODE	 (MM)	€	KOD CODE	 (MM)	€
AIMTS-7036-HPP	700x360x1830	-	AIMTS-7046-HPP	700x460x1830	-	AIMTS-7056-HPP	700x560x1830	-
AIMTS-8036-HPP	800x360x1830	-	AIMTS-8046-HPP	800x460x1830	-	AIMTS-8056-HPP	800x560x1830	-
AIMTS-9036-HPP	900x360x1830	-	AIMTS-9046-HPP	900x460x1830	-	AIMTS-9056-HPP	900x560x1830	-
AIMTS-10536-HPP	1005x360x1830	-	AIMTS-10546-HPP	1005x460x1830	-	AIMTS-10556-HPP	1005x560x1830	-
AIMTS-11536-HPP	1105x360x1830	-	AIMTS-11546-HPP	1105x460x1830	-	AIMTS-11556-HPP	1105x560x1830	-
AIMTS-12536-HPP	1205x360x1830	-	AIMTS-12546-HPP	1205x460x1830	-	AIMTS-12556-HPP	1205x560x1830	-
AIMTS-13536-HPP	1305x360x1830	-	AIMTS-13546-HPP	1305x460x1830	-	AIMTS-13556-HPP	1305x560x1830	-
AIMTS-14136-HPP	1410x360x1830	-	AIMTS-14146-HPP	1410x460x1830	-	AIMTS-14156-HPP	1410x560x1830	-
AIMTS-15136-HPP	1510x360x1830	-	AIMTS-15146-HPP	1510x460x1830	-	AIMTS-15156-HPP	1510x560x1830	-
AIMTS-16136-HPP	1610x360x1830	-	AIMTS-16146-HPP	1610x460x1830	-	AIMTS-16156-HPP	1610x560x1830	-
AIMTS-17136-HPP	1710x360x1830	-	AIMTS-17146-HPP	1710x460x1830	-	AIMTS-17156-HPP	1710x560x1830	-
AIMTS-18036-HPP	1810x360x1830	-	AIMTS-18046-HPP	1810x460x1830	-	AIMTS-18056-HPP	1810x560x1830	-



YARDIMCI NOX ÜRÜNLER AUXILIARY INOX PRODUCTS

GN KÜVETLER GN CONTAINERS

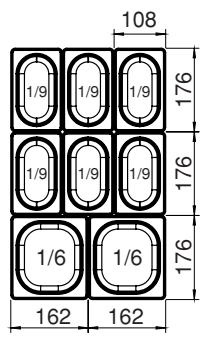
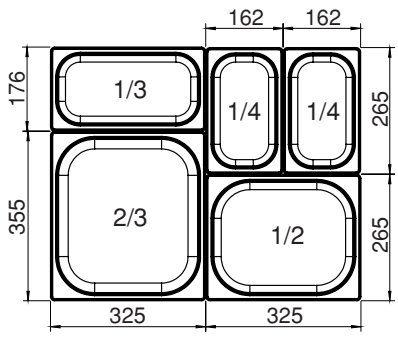
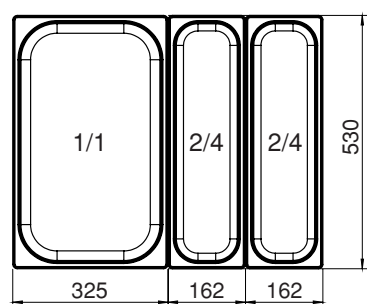
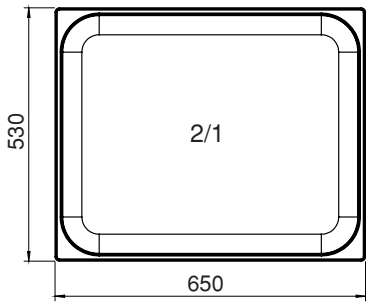

KOD CODE	AÇIKLAMA DESCRIPTION	DIŞ ÖLÇÜ (MM) EXT. DIM. (MM)	KOLİ ÖLÇÜ (MM) BOX DIM. (MM)	KUTU ADEDİ BOX UNIT	€
6005642	2/1-20	650x530x20	660x550x120	10	-
6005660	2/1-40	650x530x40	660x550x160	10	-
6005537	2/1-65	650x530x65	660x550x160	10	-
6005538	2/1-100	650x530x100	660x550x290	10	-
6005539	2/1-150	650x530x150	660x550x360	10	-
6005643	2/1-200	650x530x200	660x550x360	5	-
6005656	1/1-20	530x325x20	540x360x120	20	-
6005510	1/1-40	530x325x40	540x360x240	20	-
6005637	1/1-65	530x325x65	540x360x240	20	-
6005657	1/1-100	530x325x100	540x360x355	15	-
6005638	1/1-150	530x325x150	540x360x420	15	-
6005512	1/1-200	530x325x200	540x360x420	9	-
6005662	2/4-20	162x530x20	540x360x120	20	-
6005547	2/4-40	162x530x40	540x360x120	20	-
6005663	2/4-65	162x530x65	540x360x290	20	-
6005548	2/4-100	162x530x100	540x360x320	20	-
6005549	2/4-150	162x530x150	540x360x420	20	-
6005541	2/3-20	354x325x20	540x360x240	20	-
6005542	2/3-40	354x325x40	540x360x240	20	-
6005545	2/3-65	354x325x65	540x360x355	20	-
6005651	2/3-100	354x325x100	540x360x420	20	-
6005644	2/3-150	354x325x150	540x360x420	15	-
6005645	2/3-200	354x325x200	540x360x420	12	-
6005514	1/2-20	325x265x20	540x360x120	20	-
6005515	1/2-40	325x265x40	540x360x120	20	-
6005517	1/2-60	325x265x65	540x360x180	20	-
6005518	1/2-100	325x265x100	540x360x240	15	-
6005519	1/2-150	325x265x150	540x360x420	20	-
6005520	1/2-200	650x530x200	540x360x420	10	-
6005639	1/3-20	325x176x20	540x360x120	25	-
6005521	1/3-40	325x176x40	540x360x120	25	-
6005523	1/3-65	325x176x65	540x360x180	20	-
6005524	1/3-100	325x176x100	540x360x290	25	-
6005525	1/3-150	325x176x150	540x360x420	20	-
6005526	1/3-200	325x176x200	540x360x420	20	-
6005527	1/4-20	265x162x20	540x360x120	25	-
6005640	1/4-40	265x162x40	540x360x120	25	-
6005528	1/4-65	265x162x65	540x360x180	25	-
6005529	1/4-100	265x162x100	540x360x240	25	-
6005530	1/4-150	265x162x150	540x360x320	20	-
6005531	1/4-200	265x162x200	540x360x180	10	-
6005658	1/6-65	176x162x65	540x360x120	25	-
6005532	1/6-100	176x162x100	540x360x180	25	-
6005533	1/6-150	176x162x150	540x360x180	25	-
6005659	1/6-200	176x162x200	540x360x180	25	-
6005534	1/9-65	176x108x65	540x360x120	25	-
6005641	1/9-100	176x108x100	540x360x120	25	-

600 SERİ PIŞİRME EKİPMANLARI



600 SERIES
HOT LINE



AIM

600 SERİ 600 SERIES

GAZLI OCAKLAR GAS COOKERS

AGO106







TEKNİK DETAYLAR / TECHNICAL DETAILS

TR

- Paslanmaz çelikten imal edilmiştir
- Paslanmaz sac konstrüksiyonu ile uzun ömürlü kolay temizlenebilir ve hijyeniktir
- Cihaz pilotlu ve termokupullu kontrol sistemi bulunmaktadır.
- LPG ve NG seçenekleri mevcuttur
- Pişirici hızı yüksek alev veya düşük alev olarak ayarlanabilir

EN

- Made of stainless steel
- Stainless steel sheet construction provides hygiene, long service life and easy of cleaning
- Piloted and thermocouple control system
- LPG and NG options available
- The device speed set up to high or low flame

	KOD / CODE	 [MM]	 kg	 (KW)	€
	AIM AGO46	400x600x300	30	11,5	-
	AIM AGO66	600x600x300	34	23	-
	AIM AGO86	800x600x300	42	23	-
	AIM AGO106	1000x600x300	65	34,5	-

ELEKTRİKLİ OCAKLAR ELECTRİK COOKERS

AEO106











TEKNİK DETAYLAR / TECHNICAL DETAILS

TR

- Paslanmaz çelikten imal edilmiştir
- Paslanmaz sac konstrüksiyonu ile uzun ömürlü kolay temizlenebilir ve hijyeniktir
- Cihaz üzerinde bulunan 6 kademeli termostat ile ısıyı istenilen şekilde ayarlayabilme imkanı sağlar

EN

- Made of stainless steel
- Stainless steel sheet construction provides hygiene, long service life and easy of cleaning
- With the 6 steps thermostat on the device, it provides the opportunity to adjust the temperature as requested

	KOD / CODE	 [MM]	 kg		 [KW]	
	AIM AEO46	400x600x300	20	380-410 V	4	-
	AIM AEO66	600x600x300	28	380-410 V	8	-
	AIM AEO86	800x600x300	32	380-410 V	8	-
	AIM AEO106	1000x600x300	54	380-410 V	12	-

AIM

600 SERİ 600 SERIES

GAZLI WOK OCAKLAR GAS WOK COOKERS

AGW86







TEKNİK DETAYLAR / TECHNICAL DETAILS

TR

- Paslanmaz çelikten imal edilmiştir
- Paslanmaz sac konstrüksiyonu ile uzun ömürlü kolay temizlenebilir ve hijyeniktir
- Cihaz pilotlu ve termokupullu kontrol sistemi bulunmaktadır
- LPG ve NG seçenekleri mevcuttur
- Pişirici hızı yüksek alev veya düşük alev olarak ayarlanabilir

EN

- Made of stainless steel
- Stainless steel sheet construction provides hygiene, long service life and easy of cleaning
- Piloted and thermocouple control system
- LPG and NG options available
- The device speed set up to high or low flame

	KOD / CODE	 (MM)	 kg	 (KW)	€
	AIM AGW46	400x600x300	40	10	-
	AIM AGW86	800x600x300	67	20	-

GAZLI IZGARALAR - DÜZ PLEYT GAS GRILLS - SMOOTH SURFACE

AGI106-D







TEKNİK DETAYLAR / TECHNICAL DETAILS

TR

- Paslanmaz çelikten imal edilmiştir
- Paslanmaz sac konstrüksiyonu ile uzun ömürlü kolay temizlenebilir ve hijyeniktir
- Kullanıcıya her yönden rahatlık sağlayan ergonomik dizayna sahiptir
- Plate kalınlığı 12 mm. ST52 çelik malzemeden üretilmiştir
- LPG ve NG seçenekleri mevcuttur
- Her biri bağımsız brülörler sayesinde homojen ısı dağılımı sağlanmaktadır

EN

- Made of stainless steel
- Stainless steel sheet construction provides hygiene, long service life and easy of cleaning
- Ergonomic design providing convenience to users in all aspects
- Plate thickness is produced as 12 mm. made of ST52 stainless steel
- LPG and NG options available
- Specially designed tubular burner to ensure homogeneous cooking across plate surfaces

	KOD / CODE	(MM)	kg	(KW)	€
	AIM AGI46-D	400x600x300	41	4,7	-
	AIM AGI66-D	600x600x300	59	7,4	-
	AIM AGI86-D	800x600x300	71	9,4	-
	AIM AGI106-D	1000x600x300	88	13	-

AIM

600 SERİ 600 SERIES

GAZLI IZGARALAR - NERVÜRLÜ PLEYT GAS GRILLS - RIBBED SURFACE

AGI106-N



NERVÜRLÜ PLEYT
RIBBED SURFACE







TEKNİK DETAYLAR / TECHNICAL DETAILS

TR

- Paslanmaz çelikten imal edilmiştir.
- Paslanmaz sac konstrüksiyonu ile uzun ömürlü kolay temizlenebilir ve hijyeniktir.
- Kullanıcıya her yönden rahatlık sağlayan ergonomik dizayna sahiptir.
- Plate kalınlığı 12 mm. ST52 çelik malzemeden üretilmiştir.
- LPG ve NG seçenekleri mevcuttur.
- Her biri bağımsız brülörler sayesinde homojen ısı dağılımı sağlanmaktadır.

EN

- Made of stainless steel.
- Stainless steel sheet construction provides hygiene, long service life and easy of cleaning.
- Ergonomic design providing convenience to users in all aspects.
- Plate thickness is produced as 12 mm. made of ST52 stainless steel.
- LPG and NG options available.
- Specially designed tubular burner to ensure homogeneous cooking across plate surfaces.

	KOD / CODE	 (MM)	 kg	 (KW)	€
	AIM AGI46-N	400x600x300	41	4,7	-
	AIM AGI66-N	600x600x300	59	7,4	-
	AIM AGI86-N	800x600x300	71	9,4	-
	AIM AGI106-N	1000x600x300	88	13	-

GAZLI IZGARALAR - 1/2 NERVÜRLÜ 1/2 DÜZ PLEYT GAS GRILLS - 1/2 RIBBED 1/2 SMOOTH SURFACE

AGI106-ND









TEKNİK DETAYLAR / TECHNICAL DETAILS

TR

- Paslanmaz çelikten imal edilmiştir.
- Paslanmaz sac konstrüksiyonu ile uzun ömürlü kolay temizlenebilir ve hijyeniktir.
- Kullanıcıya her yönden rahatlık sağlayan ergonomik dizayna sahiptir.
- Plate kalınlığı 12 mm. ST52 çelik malzemedен üretilmiştir.
- LPG ve NG seçenekleri mevcuttur.
- Her biri bağımsız brülörler sayesinde homojen ısı dağılımı sağlanmaktadır.

EN

- Made of stainless steel.
- Stainless steel sheet construction provides hygiene, long service life and easy of cleaning.
- Ergonomic design providing convenience to users in all aspects.
- Plate thickness is produced as 12 mm. made of ST52 stainless steel.
- LPG and NG options available.
- Specially designed tubular burner to ensure homogeneous cooking across plate surfaces.

	KOD / CODE	 (MM)	 kg	 (KW)	€
	AIM AGI166-ND	600x600x300	59	7,4	-
	AIM AGI186-ND	800x600x300	71	9,4	-
	AIM AGI106-ND	1000x600x300	88	13	-

AIM

600 SERİ 600 SERIES

GAZLI IZGARALAR - DÜZ PLEYT - KROM GAS GRILLS - SMOOTH SURFACE - CHROME

CHROME

AGI106-DK







TEKNİK DETAYLAR / TECHNICAL DETAILS

TR

- Paslanmaz çelikten imal edilmiştir.
- Paslanmaz sac konstrüksiyonu ile uzun ömürlü kolay temizlenebilir ve hijyeniktir.
- Kullanıcıya her yönden rahatlık sağlayan ergonomik dizayna sahiptir.
- Plate kalınlığı 12 mm. ST52 çelik malzemeden üretilmiştir.
- LPG ve NG seçenekleri mevcuttur.
- Her biri bağımsız brülörler sayesinde homojen ısı dağılımı sağlanmaktadır.

EN

- Made of stainless steel.
- Stainless steel sheet construction provides hygiene, long service life and easy of cleaning.
- Ergonomic design providing convenience to users in all aspects.
- Plate thickness is produced as 12 mm. made of ST52 stainless steel.
- LPG and NG options available.
- Specially designed tubular burner to ensure homogeneous cooking across plate surfaces.

	KOD / CODE	(MM)	kg	(KW)	€
	AIM AGI46-DK	400x600x300	41	4,7	-
	AIM AGI66-DK	600x600x300	59	7,4	-
	AIM AGI86-DK	800x600x300	71	9,4	-
	AIM AGI106-DK	1000x600x300	88	13	-

GAZLI IZGARALAR - NERVÜRLÜ PLEYT - KROM GAS GRILLS - RIBBED SURFACE - CHROME

CHROME

AGI106-NK



NERVÜRLÜ PLEYT
RIBBED SURFACE





TEKNİK DETAYLAR / TECHNICAL DETAILS

TR

- Paslanmaz çelikten imal edilmiştir.
- Paslanmaz sac konstrüksiyonu ile uzun ömürlü kolay temizlenebilir ve hijyeniktir.
- Kullanıcıya her yönden rahatlık sağlayan ergonomik dizayna sahiptir.
- Plate kalınlığı 12 mm. ST52 çelik malzemeden üretilmiştir.
- LPG ve NG seçenekleri mevcuttur.
- Her biri bağımsız brülörler sayesinde homojen ısı dağılımı sağlanmaktadır.

EN

- Made of stainless steel.
- Stainless steel sheet construction provides hygiene, long service life and easy of cleaning.
- Ergonomic design providing convenience to users in all aspects.
- Plate thickness is produced as 12 mm. made of ST52 stainless steel.
- LPG and NG options available.
- Specially designed tubular burner to ensure homogeneous cooking across plate surfaces.

	KOD / CODE	(MM)	kg	(KW)	€
	AIM AGI46-NK	400x600x300	41	4,7	-
	AIM AGI66-NK	600x600x300	59	7,4	-
	AIM AGI86-NK	800x600x300	71	9,4	-
	AIM AGI106-NK	1000x600x300	88	13	-

AIM

600 SERİ 600 SERIES

GAZLI IZGARALAR - 1/2 NERVÜRLÜ 1/2 DÜZ PLEYT - KROM GAS GRILLS - 1/2 RIBBED 1/2 SMOOTH SURFACE - CHROME

CHROME

AGI106-NDK



1/2 NERVÜRLÜ 1/2 DÜZ PLEYT
1/2 RIBBED 1/2 SURFACE SURFACE







TEKNİK DETAYLAR / TECHNICAL DETAILS

TR

- Paslanmaz çelikten imal edilmiştir.
- Paslanmaz sac konstrüksiyonu ile uzun ömürlü kolay temizlenebilir ve hijyeniktir.
- Kullanıcıya her yönden rahatlık sağlayan ergonomik dizayna sahiptir.
- Plate kalınlığı 12 mm. ST52 çelik malzemeden üretilmiştir.
- LPG ve NG seçenekleri mevcuttur.
- Her biri bağımsız brülörler sayesinde homojen ısı dağılımı sağlanmaktadır.

EN

- Made of stainless steel.
- Stainless steel sheet construction provides hygiene, long service life and easy of cleaning.
- Ergonomic design providing convenience to users in all aspects.
- Plate thickness is produced as 12 mm. made of ST52 stainless steel.
- LPG and NG options available.
- Specially designed tubular burner to ensure homogeneous cooking across plate surfaces.

	KOD / CODE	 (MM)	 kg	 (KW)	€
	AIM AGI66-NDK	600x600x300	59	7,4	-
	AIM AGI86-NDK	800x600x300	71	9,4	-
	AIM AGI106-NDK	1000x600x300	88	13	-

ELEKTRİKLİ IZGARALAR - DÜZ PLEYT ELECTRICAL GRILLS - SMOOTH SURFACE

AEI106-D











TEKNİK DETAYLAR / TECHNICAL DETAILS

TR

- Paslanmaz çelikten imal edilmiştir.
- Paslanmaz sac konstrüksiyonu ile uzun ömürlü kolay temizlenebilir ve hijyeniktir.
- Kullanıcıya her yönden rahatlık sağlayan ergonomik dizayna sahiptir.
- Plate kalınlığı 12 mm. ST52 çelik malzemeden üretilmiştir.
- Cihazda bulunan rezistanslar sayesinde pişirme yüzeyinde homojen bir ısı dağılımı sağlanır.

EN

- Made of stainless steel.
- Stainless steel sheet construction provides hygiene, long service life and easy of cleaning.
- Ergonomic design providing convenience to users in all aspects.
- Plate thickness is produced as 12 mm. made of ST52 stainless steel.
- Specially designed heating elements to ensure homogeneous cooking across plate surfaces.

	KOD / CODE	 (MM)	 kg		 (KW)	
	AIM AEI46-D	400x600x300	41	380-410 V	4,5	-
	AIM AEI66-D	600x600x300	59	380-410 V	6	-
	AIM AEI86-D	800x600x300	71	380-410 V	9	-
	AIM AEI106-D	1000x600x300	88	380-410 V	10,8	-

AIM

600 SERİ 600 SERIES

ELEKTRİKLİ IZGARALAR - NERVÜRLÜ PLEYT ELECTRICAL GRILLS - RIBBED SURFACE

AEI106-N











TEKNİK DETAYLAR / TECHNICAL DETAILS

TR

- Paslanmaz çelikten imal edilmiştir.
- Paslanmaz sac konstrüksiyonu ile uzun ömürlü kolay temizlenebilir ve hijyeniktir.
- Kullanıcıya her yönden rahatlık sağlayan ergonomik dizayna sahiptir.
- Plate kalınlığı 12 mm. ST52 çelik malzemeden üretilmiştir.
- Cihazda bulunan rezistanslar sayesinde pişirme yüzeyinde homojen bir ısı dağılımı sağlanır.

EN

- Made of stainless steel.
- Stainless steel sheet construction provides hygiene, long service life and easy of cleaning.
- Ergonomic design providing convenience to users in all aspects.
- Plate thickness is produced as 12 mm. made of ST52 stainless steel.
- Specially designed heating elements to ensure homogeneous cooking across plate surfaces.

	KOD / CODE	 (MM)	 kg		 (KW)	
	AIM AEI46-N	400x600x300	41	380-410 V	4,5	-
	AIM AEI66-N	600x600x300	59	380-410 V	6	-
	AIM AEI86-N	800x600x300	71	380-410 V	9	-
	AIM AEI106-N	1000x600x300	88	380-410 V	10,8	-

ELEKTRİKLİ IZGARALAR - 1/2 NERVÜRLÜ 1/2 DÜZ PLEYT ELECTRICAL GRILLS - 1/2 RIBBED 1/2 SMOOTH SURFACE

AEI106-ND











TEKNİK DETAYLAR / TECHNICAL DETAILS

TR

- Paslanmaz çelikten imal edilmiştir.
- Paslanmaz sac konstrüksiyonu ile uzun ömürlü kolay temizlenebilir ve hijyeniktir.
- Kullanıcıya her yönden rahatlık sağlayan ergonomik dizayna sahiptir.
- Plate kalınlığı 12 mm. ST52 çelik malzemeden üretilmiştir.
- Cihazda bulunan rezistanslar sayesinde pişirme yüzeyinde homojen bir ısı dağılımı sağlar.

EN

- Made of stainless steel.
- Stainless steel sheet construction provides hygiene, long service life and easy of cleaning.
- Ergonomic design providing convenience to users in all aspects.
- Plate thickness is produced as 12 mm. made of ST52 stainless steel.
- Specially designed heating elements to ensure homogeneous cooking across plate surfaces.

	KOD / CODE	 (MM)	 kg		 (KW)	
	AIM AEI66-ND	600x600x300	59	380-410 V	6	-
	AIM AEI86-ND	800x600x300	71	380-410 V	9	-
	AIM AEI106-ND	1000x600x300	88	380-410 V	10,8	-

AIM

600 SERİ 600 SERIES

ELEKTRİKLİ IZGARALAR - DÜZ PLEYT - KROM ELECTRICAL GRILLS - SMOOTH SURFACE - CHROME

CHROME

AEI106-DK











TEKNİK DETAYLAR / TECHNICAL DETAILS

TR

- Paslanmaz çelikten imal edilmiştir.
- Paslanmaz sac konstrüksiyonu ile uzun ömürlü kolay temizlenebilir ve hijyeniktir.
- Kullanıcıya her yönden rahatlık sağlayan ergonomik dizayna sahiptir.
- Plate kalınlığı 12 mm. ST52 çelik malzemeden üretilmiştir.
- Cihazda bulunan rezistanslar sayesinde pişirme yüzeyinde homojen bir ısı dağılımı sağlar.

EN

- Made of stainless steel.
- Stainless steel sheet construction provides hygiene, long service life and easy of cleaning.
- Ergonomic design providing convenience to users in all aspects.
- Plate thickness is produced as 12 mm. made of ST52 stainless steel.
- Specially designed heating elements to ensure homogeneous cooking across plate surfaces.

	KOD / CODE	 (MM)	 kg		 (KW)	
	AIM AEI46-DK	400x600x300	41	380-410 V	4,5	-
	AIM AEI66-DK	600x600x300	59	380-410 V	6	-
	AIM AEI86-DK	800x600x300	71	380-410 V	9	-
	AIM AEI106-DK	1000x600x300	88	380-410 V	10,8	-

ELEKTRİKLİ IZGARALAR - NERVÜRLÜ PLEYT - KROM

ELECTRICAL GRILLS - RIBBED SURFACE - CHROME

CHROME

AEI106-NK



NERVÜRLÜ PLEYT
RIBBED SURFACE









TEKNİK DETAYLAR / TECHNICAL DETAILS

TR

- Paslanmaz çelikten imal edilmiştir.
- Paslanmaz sac konstrüksiyonu ile uzun ömürlü kolay temizlenebilir ve hijyeniktir.
- Kullanıcıya her yönden rahatlık sağlayan ergonomik dizayna sahiptir.
- Plate kalınlığı 12 mm. ST52 çelik malzemeden üretilmiştir.
- Cihazda bulunan rezistanslar sayesinde pişirme yüzeyinde homojen bir ısı dağılımı sağlanır.

EN

- Made of stainless steel.
- Stainless steel sheet construction provides hygiene, long service life and easy of cleaning.
- Ergonomic design providing convenience to users in all aspects.
- Plate thickness is produced as 12 mm. made of ST52 stainless steel.
- Specially designed heating elements to ensure homogeneous cooking across plate surfaces.

	KOD / CODE	 [MM]	 kg		 [KW]	
	AIM AEI46-NK	400x600x300	41	380-410 V	4,5	-
	AIM AEI66-NK	600x600x300	59	380-410 V	6	-
	AIM AEI86-N	800x600x300	71	380-410 V	9	-
	AIM AEI106-NK	1000x600x300	88	380-410 V	10,8	-

AIM

600 SERİ 600 SERIES

ELEKTRİKLİ IZGARALAR - 1/2 NERVÜRLÜ 1/2 DÜZ PLEYT - KROM ELECTRICAL GRILLS - 1/2 RIBBED 1/2 SMOOTH SURFACE - CHROME

CHROME

AEI106-NDK



1/2 NERVÜRLÜ 1/2 DÜZ PLEYT
1/2 RIBBED 1/2 SURFACE SURFACE







TEKNİK DETAYLAR / TECHNICAL DETAILS

TR

- Paslanmaz çelikten imal edilmiştir.
- Paslanmaz sac konstrüksiyonu ile uzun ömürlü kolay temizlenebilir ve hijyeniktir.
- Kullanıcıya her yönden rahatlık sağlayan ergonomik dizayna sahiptir.
- Plate kalınlığı 12 mm. ST52 çelik malzemeden üretilmiştir.
- LPG ve NG seçenekleri mevcuttur.
- Her biri bağımsız brülörler sayesinde homojen ısı dağılımı sağlanmaktadır.

EN

- Made of stainless steel.
- Stainless steel sheet construction provides hygiene, long service life and easy of cleaning.
- Ergonomic design providing convenience to users in all aspects.
- Plate thickness is produced as 12 mm. made of ST52 stainless steel.
- LPG and NG options available.
- Specially designed tubular burner to ensure homogeneous cooking across plate surfaces.

	KOD / CODE	 (MM)	 kg		 (KW)	€
	AIM AEI66-NDK	600x600x300	59	380-410 V	6	-
	AIM AEI86-NDK	800x600x300	71	380-410 V	9	-
	AIM AEI106-NDK	1000x600x300	88	380-410 V	10,8	-

GAZLI LAVATAŞLI IZGARALAR GAS LAVASTONE GRILLS

ALG86









TEKNİK DETAYLAR / TECHNICAL DETAILS

TR

- Paslanmaz çelikten imal edilmiştir.
- Paslanmaz sac konstrüksiyonu ile uzun ömürlü kolay temizlenebilir ve hijyeniktir.
- Kullanıcıya her yönden rahatlık sağlayan ergonomik dizayna sahiptir.
- Yağ haznesi kapasitesi maksimum; E ALG 460 ve E ALG 660 modelinde 2,6 lt., E ALG 860 modelinde 2 x 2,6 lt.
- Cihazda pişirme yapılan ızgara kısmı AISI 304 bükümlü sacdan imal edilmiştir.
- LPG ve NG seçenekleri mevcuttur.

EN

- Made of stainless steel.
- Stainless steel sheet construction provides hygiene, long service life and easy of cleaning.
- Ergonomic design providing convenience to users in all aspects.
- Oil drawer capacity; E ALG 460 ve E ALG 660 models 2,6 lt., E ALG 860 models 2 x 2,6 lt.
- LPG and NG options available.

	KOD / CODE	 (MM)	 kg	 (KW)	€
	AIM ALG46	400x600x300	35	6,5	-
	AIM ALG66	600x600x300	52	9,3	-
	AIM ALG86	800x600x300	62	13	-

AIM

600 SERİ 600 SERIES

ELEKTRİKLİ AMERİKAN IZGARALAR ELECTRICAL AMERICAN GRILLS

ALE66







TEKNİK DETAYLAR / TECHNICAL DETAILS

TR

- Paslanmaz çelikten imal edilmiştir.
- Paslanmaz sac konstrüksiyonu ile uzun ömürlü kolay temizlenebilir ve hijyeniktir.
- Kullanıcıya her yönden rahatlık sağlayan ergonomik dizayna sahiptir.
- Tabanda bulunan hazne içerisindeki su, yağdan kaynaklı duman ve koku oluşumunu minimize eder.
- Cihaz üzerinde bulunan 7 kademeli termostat ile ısıyı istenilen şekilde ayarlayabilme imkanı sağlar.
- Tahliye musluğu bulunmaktadır.
- Cihazdaki rezistanslar yukarı yönlü hareketli olup kolay temizlik imkanı sağlar.

EN

- Made of stainless steel.
- Stainless steel sheet construction provides hygiene, long service life and easy of cleaning.
- Ergonomic design providing convenience to users in all aspects.
- With the 7 steps thermostat on the device, it provides the opportunity to adjust the temperature as requested.
- Equipped drain tap.
- When the resistors are in the upward position, the electricity is cut off with safety switch.

	KOD / CODE	 (MM)	 kg		 [KW]	€
	AIM ALE46	400x600x300	35	220-240 V	2,7	-
	AIM ALE66	600x600x300	52	380-410 V	4,5	-

ELEKTRİKLİ FRİTÖZLER ELECTRICAL FRYERS

AEF86











TEKNİK DETAYLAR / TECHNICAL DETAILS

TR

- Paslanmaz çelikten imal edilmiştir.
- Paslanmaz sac konstrüksiyonu ile uzun ömürlü kolay temizlenebilir ve hijyeniktir.
- Kullanıcıya her yönden rahatlık sağlayan ergonomik dizayna sahiptir.
- Yağ sıcaklığı 100°C -190°C arasında termostat ile kontrol edilir.
- Cihazda emniyet amaçlı limit termostatu bulunur.
- Cihazdaki rezistanslar yukarı yönlü hareketli olup kolay temizlik imkanı sağlar.

EN

- Made of stainless steel.
- Stainless steel sheet construction provides hygiene, long service life and easy of cleaning.
- Ergonomic design providing convenience to users in all aspects.
- Oil temperature is controlled by thermostat between 100°-190°C.
- Equipped with limiting thermostat.
- When the resistors are in the upward position, the electricity is cut of with safety switch.

	KOD / CODE	 (MM)	 kg	KAPASİTE / CAPACITY		 (KW)	€
	AIM AEF36	300x600x300	21	Min. 4,5 lt Max. 9 lt.	380-410 V	7,5	-
	AIM AEF46	400x600x300	23	Min. 5 lt Max. 12 lt.	380-410 V	9	-
	AIM AEF66	600x600x300	36	Min. 2x4,5 lt Max. 2x9 lt.	380-410 V	15	-
	AIM AEF86	800x600x300	41	Min. 2x5 lt Max. 2x12 lt.	380-410 V	18	-

AIM

600 SERİ 600 SERIES

GAZLI FRİTÖZLER GAS FRYERS

AGF86









TEKNİK DETAYLAR / TECHNICAL DETAILS

TR

- Paslanmaz çelikten imal edilmiştir.
- Paslanmaz sac konstrüksiyonu ile uzun ömürlü kolay temizlenebilir ve hijyeniktir.
- Kullanıcıya her yönden rahatlık sağlayan ergonomik dizayna sahiptir.
- Cihazda yüksek kalori sağlayan brülörler kullanılmaktadır.
- Cihaz üzerinde bulunan 7 kademeli termostat ile ısıyı istenilen şekilde ayarlayabilme imkanı sağlar.
- Cihazda pilotlu ve termokupullu kontrol sistemi bulunmaktadır. Termokupul sayesinde alev söndüğünde cihaza gelen gaz otomatik olarak kesilir.

EN

- Made of stainless steel.
- Stainless steel sheet construction provides hygiene, long service life and easy of cleaning.
- Ergonomic design providing convenience to users in all aspects.
- LPG and NG options available
- Specially designed tubular burner to ensure homogeneous cooking across plate surfaces.
- With the 7 steps thermostat on the device, it provides the opportunity to adjust the temperature as requested.

	KOD / CODE	 (MM)	 kg	KAPASİTE / CAPACITY	 (KW)	€
	AIM AGF46	400x600x300	25	Min. 9 lt Max. 11 lt.	5,3	-
	AIM AGF66	600x600x300	41	Min. 2x7 lt Max. 2x8 lt.	10,6	-
	AIM AGF86	800x600x300	47	Min. 2x9 lt Max. 2x9 lt.	10,6	-

PATATES DİNLENDİRME CHIPS SCUTTLE

AWK46









TEKNİK DETAYLAR / TECHNICAL DETAILS

TR

- Paslanmaz çelikten imal edilmiştir.
- Paslanmaz sac konstrüksiyonu ile uzun ömürlü kolay temizlenebilir ve hijyeniktir.
- Cihaz içerisinde yağın süzülmesi için delikli sac bulunmaktadır.
- Cihazda seramik rezistans kullanılmıştır.

EN

- Made of stainless steel.
- Stainless steel sheet construction provides hygiene, long service life and easy of cleaning.
- Equipped with porcelain heater.
- Used for holding chips at perfect serving temperature and condition.

	KOD / CODE	 (MM)	 kg	KAPASİTE / CAPACITY		 (KW)	€
	AIM AWK36	300x600x300	15	GN 1/2 150	220-240 V	0,65	-
	AIM AWK46	400x600x300	18	GN 2/3 150	220-240 V	0,65	-

AIM

600 SERİ 600 SERIES

ELEKTRİKLİ BENMARI ELECTRICAL BAINMARIE

BN66







TEKNİK DETAYLAR / TECHNICAL DETAILS

TR

- Paslanmaz çelikten imal edilmiştir.
- Paslanmaz sac konstrüksiyonu ile uzun ömürlü kolay temizlenebilir ve hijyeniktir.
- Cihaz 30°-90°C aralığında termostat ile kontrol edilir.
- Cihazda kilitli boşaltma vanası sayesinde kullanıcı kontrolü dışında açılıp boşaltma yapılamaz.

EN

- Made of stainless steel.
- Stainless steel sheet construction provides hygiene, long service life and easy of cleaning.
- Ergonomic design providing convenience to users in all aspects.
- The device is controlled by a thermostat in the range of 30°-90°C .

	KOD / CODE	 (MM)	 kg	KAPASİTE / CAPACITY	 220-240 V	 (KW)	€
	AIM BN36	300x600x300	15	GN 1/4 + GN 1/2	220-240 V	1,2	-
	AIM BN46	400x600x300	24	GN 1/2 + GN 1/3	220-240 V	1,4	-
	AIM BN66	600x600x300	31	GN 1/1 + GN 1/4 x2	220-240 V	2,1	-

ELEKTRİKLİ MAKARNA HAŞLAMALAR ELECTRICAL PASTA COOKERS

PC66











TEKNİK DETAYLAR / TECHNICAL DETAILS

TR

- Paslanmaz çelikten imal edilmiştir.
- Paslanmaz sac konstrüksiyonu ile uzun ömürlü kolay temizlenebilir ve hijyeniktir.
- Cihazda kilitli boşaltma vanası sayesinde kullanıcı kontrolü dışında açılıp boşaltma yapılamaz.
- Cihazda temiz su girişi musluğu ve taşan su tahliyesi mevcuttur.
- Cihazda enerji regülatörü ile ısı kontrolü sağlanır.
- Aşırı ısınmaya karşı limit termostat bulunur.

EN

- Made of stainless steel.
- Stainless steel sheet construction provides hygiene long service life and easy of cleaning.
- The device has a locked drain valve. It cannot be turned on/off without user control.
- The device has a clean water inlet tap and an overflowing water drain.
- Heat control is provided by the energy regulator in the device.
- It has a heat regulator against over heating.

	KOD / CODE	 [MM]	 kg	 V	 [KW]	 €
	AIM PC36	300x600x300	19	220-240 V	3	-
	AIM PC46	400x600x300	23	380-410 V	5	-
	AIM PC66	600x600x300	28	380-410 V	7,5	-

AIM

600 SERİ 600 SERIES

ELEKTRİKLİ SETALTI FIRINLAR ELECTRICAL UNDERCOUNTER OVENS

SFEF106









TEKNİK DETAYLAR / TECHNICAL DETAILS

TR

- Paslanmaz çelikten imal edilmiştir.
- Paslanmaz sac konstrüksiyonu ile uzun ömürlü kolay temizlenebilir ve hijyeniktir.
- Cihazda bulunan rezistanslar 50°-300°C aralığında çalışır. isteğe göre ayrı ayrı kontrol edilebilir.
- ST modellerinde; cihazın tabanında ısıyı homojen olarak dağıtmak için 10 mm. kalınlığında ST Serisi çelik plate bulunmaktadır.
- F modellerinde; fırında iç hacmi homojen olarak ısıtan AC fan bulunmaktadır.
- Ürün üzerinde aynı seriden farklı ürünler konumlandırılabilir.
- Fırın içerisinde 2 adet 530 x 400 mm. tel ızgara bulunmaktadır.

EN

- Made of stainless Steel
- Stainless steel sheet construction provides hygiene, long service life and easy of cleaning.
- The resistances in the device operate in the range of 50°-300°C degrees. It can be individually controlled optionally.
- In the ST model, in order to homogenize the heat at the base of the device, 10mm thick ST model steel is produced.
- There is an AC fan that heats the internal volume homogeneously in F models.
- Different products from the same series can be put on the product.
- There are 2 pieces 530x400 mm wire grids in the oven.

	KOD / CODE	 (MM)	 kg	KAPASİTE / CAPACITY		 (KW)	€
	AIM SSEF86	800x600x550	35	GN 1/1	380-415 V	4,3	-
	AIM SFEF86	800x600x550	35	GN 1/1	220-240 V	2,6	-
	AIM SSEF106	1000x600x550	45	GN 1/1	380-415 V	4,3	-
	AIM SFEF106	1000x600x550	45	GN 1/1	220-240 V	2,6	-

GAZLI SETALTI FIRINLAR GAS UNDERCOUNTER OVENS

SGF106







TEKNİK DETAYLAR / TECHNICAL DETAILS

TR

- Paslanmaz çelikten imal edilmiştir.
- Paslanmaz sac konstrüksiyonu ile uzun ömürlü kolay temizlenebilir ve hijyeniktir.
- Fırında sıcaklık 60° -300° C aralığında bir adet termostatlı gaz musluğu ile kontrol edilir.
- Cihazda pilotlu ve termokupullu kontrol sistemi bulunmaktadır. Termokupul sayesinde alev söndüğünde cihaza gelen gaz otomatik olarak kesilir.
- LPG ve NG seçenekleri mevcuttur.

EN

- Made of stainless Steel
- Stainless steel sheet construction provides hygiene, long service life and easy of cleaning.
- The temperature in the oven is controlled by a thermostatic gas tap in the range of 60°-300°C degrees.
- The device has a piloted and thermocouple control system. When the flame goes out with the thermocouple, the gas coming to the device is automatically cut off.
- LPG and NG options available.

	KOD / CODE	 [MM]	 kg	KAPASİTE / CAPACITY	 [KW]	€
	AIM SGF86	800x600x550	42	GN 1/1	4,5	-
	AIM SGF106	1000x600x550	50	GN 1/1	4,5	-

AIM

600 SERİ 600 SERIES

NÖTR TEZGAHLAR NEUTRAL WORKTOP

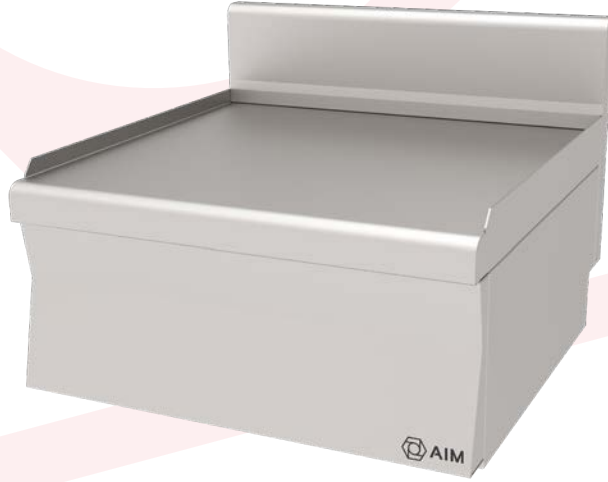
NW66





TEKNİK DETAYLAR / TECHNICAL DETAILS

TR

- Paslanmaz çelikten imal edilmiştir.
- Paslanmaz sac konstrüksiyonu ile uzun ömürlü kolay temizlenebilir ve hijyeniktir.
- Kullanıcıya her açıdan kolaylık sağlayan ergonomik tasarım.

EN

- Made of stainless steel.
- Stainless steel sheet construction provides hygiene, long service life and easy of cleaning.
- Ergonomic design providing convenience to users in all aspects.

	KOD / CODE	 (MM)	 kg	€
	AIM NW36	300x600x300	9	-
	AIM NW46	400x600x300	13	-
	AIM NW66	600x600x300	17	-

SATALTI DOLAPLAR UNDERCOUNTER CABINETS

UC106









TEKNİK DETAYLAR / TECHNICAL DETAILS

TR

- Paslanmaz çelikten imal edilmiştir.
- Paslanmaz sac konstrüksiyonu ile uzun ömürlü kolay temizlenebilir ve hijyeniktir.
- Kapılar çift cidarlıdır.
- Setaltı tezgahların üzerinde bulunan pimler cihazların altındaki yuvalara göre tasarlanmış olup ürünlerin tek parça olarak görünmesini sağlar.

EN

- Made of stainless steel.
- Stainless steel sheet construction provides hygiene, long service life and easy of cleaning.
- Double-wall walled.
- Pins on the undercounter cabinets are designed for the top equipment so that the products have a uniform look.

	KOD / CODE	 (MM)	 kg	€
	AIM UC36	300x600x550	12	-
	AIM UC46	400x600x550	14	-
	AIM UC66	600x600x550	18	-
	AIM UC86	800x600x550	23	-
	AIM UC106	1000x600x550	27	-

730 SERİ PIŞİRME EKİPMANLARI



730 SERIES HOT LINE



AIM



AIM

730 SERİ 730 SERIES

GAZLI OCAKLAR GAS COOKERS

AGO127







TEKNİK DETAYLAR / TECHNICAL DETAILS

TR

- Paslanmaz çelikten imal edilmiştir
- Paslanmaz sac konstrüksiyonu ile uzun ömürlü kolay temizlenebilir ve hijyeniktir
- Cihaz pilotlu ve termokupullu kontrol sistemi bulunmaktadır.
- LPG ve NG seçenekleri mevcuttur
- Pişirici hızı yüksek alev veya düşük alev olarak ayarlanabilir

EN

- Made of stainless steel
- Stainless steel sheet construction provides hygiene, long service life and easy of cleaning
- Piloted and thermocouple control system
- LPG and NG options available
- The device speed set up to high or low flame

	KOD / CODE	 (MM)	 kg	 (KW)	€
	AIM AGO47	400x730x300	26	11,5	-
	AIM AGO87	800x730x300	42	23	-
	AIM AGO127	1200x730x300	72	34,5	-

ELEKTRİKLİ OCAKLAR - YUVARLAK PLEYT ELECTRİK COOKERS - ROUND









TEKNİK DETAYLAR / TECHNICAL DETAILS

TR

- Paslanmaz çelikten imal edilmiştir
- Paslanmaz sac konstrüksiyonu ile uzun ömürlü kolay temizlenebilir ve hijyeniktir
- Cihaz üzerinde bulunan 6 kademeli termostat ile ısıyı istenilen şekilde ayarlayabilme imkanı sağlar

EN

- Made of stainless steel
- Stainless steel sheet construction provides hygiene, long service life and easy of cleaning
- With the 6 steps thermostat on the device, it provides the opportunity to adjust the temperature as requested

	KOD / CODE	 (MM)	 kg		 (KW)	€
	AIM AEO47-Y	400x730x300	26	380-410 V	5,2	-
	AIM AEO87-Y	800x730x300	42	380-410 V	10,4	-
	AIM AEO127-Y	1200x730x300	53	380-410 V	15,6	-

AIM

730 SERİ 730 SERIES

ELEKTRİKLİ OCAKLAR - KARE PLEYT ELECTRİK COOKERS - SQUARE

AE0127-K**300****300**







TEKNİK DETAYLAR / TECHNICAL DETAILS

TR

- Paslanmaz çelikten imal edilmiştir
- Paslanmaz sac konstrüksiyonu ile uzun ömürlü kolay temizlenebilir ve hijyeniktir
- Cihaz üzerinde bulunan 6 kademeli termostat ile ısıyı istenilen şekilde ayarlayabilme imkanı sağlar

EN

- Made of stainless steel
- Stainless steel sheet construction provides hygiene, long service life and easy of cleaning
- With the 6 steps thermostat on the device, it provides the opportunity to adjust the temperature as requested

	KOD / CODE	 (MM)	 kg	 V	 (KW)	€
	AIM AE047-K	400x730x300	26	380-410 V	5,2	-
	AIM AE087-K	800x730x300	42	380-410 V	10,4	-
	AIM AE0127-K	1200x730x300	53	380-410 V	15,6	-

GAZLI WOK OCAKLAR GAS WOK COOKERS

AGW87







TEKNİK DETAYLAR / TECHNICAL DETAILS

TR

- Paslanmaz çelikten imal edilmiştir
- Paslanmaz sac konstrüksiyonu ile uzun ömürlü kolay temizlenebilir ve hijyeniktir
- Cihaz pilotlu ve termokupullu kontrol sistemi bulunmaktadır
- LPG ve NG seçenekleri mevcuttur
- Pişirici hızı yüksek alev veya düşük alev olarak ayarlanabilir

EN

- Made of stainless steel
- Stainless steel sheet construction provides hygiene, long service life and easy of cleaning
- Piloted and thermocouple control system
- LPG and NG options available
- The device speed set up to high or low flame

	KOD / CODE	 (MM)	 kg	 (KW)	€
	AIM AGW47	400x730x300	38	10	-
	AIM AGW87	800x730x300	50	20	-

AIM

730 SERİ 730 SERIES

GAZLI IZGARALAR - DÜZ PLEYT GAS GRILLS - SMOOTH SURFACE

AGI127-D**DÜZ PLEYT
SMOOTH SURFACE**







TEKNİK DETAYLAR / TECHNICAL DETAILS

TR

- Paslanmaz çelikten imal edilmiştir
- Paslanmaz sac konstrüksiyonu ile uzun ömürlü kolay temizlenebilir ve hijyeniktir
- Kullanıcıya her yönden rahatlık sağlayan ergonomik dizayna sahiptir
- Plate kalınlığı 12 mm. ST52 çelik malzemeden üretilmiştir
- LPG ve NG seçenekleri mevcuttur
- Her biri bağımsız brülörler sayesinde homojen ısı dağılımı sağlanmaktadır

EN

- Made of stainless steel
- Stainless steel sheet construction provides hygiene, long service life and easy of cleaning
- Ergonomic design providing convenience to users in all aspects
- Plate thickness is produced as 12 mm. made of ST52 stainless steel
- LPG and NG options available
- Specially designed tubular burner to ensure homogeneous cooking across plate surfaces

	KOD / CODE	 (MM)	 kg	 (KW)	€
	AIM AGI47-D	400x730x300	47	6,3	-
	AIM AGI67-D	600x730x300	53	9	-
	AIM AGI87-D	800x730x300	78	12,6	-
	AIM AGI127-D	1200x730x300	125	18,9	-

GAZLI IZGARALAR - NERVÜRLÜ PLEYT GAS GRILLS - RIBBED SURFACE









TEKNİK DETAYLAR / TECHNICAL DETAILS

TR

- Paslanmaz çelikten imal edilmiştir.
- Paslanmaz sac konstrüksiyonu ile uzun ömürlü kolay temizlenebilir ve hijyeniktir.
- Kullanıcıya her yönden rahatlık sağlayan ergonomik dizayna sahiptir.
- Plate kalınlığı 12 mm. ST52 çelik malzemeden üretilmiştir.
- LPG ve NG seçenekleri mevcuttur.
- Her biri bağımsız brülörler sayesinde homojen ısı dağılımı sağlanmaktadır.

EN

- Made of stainless steel.
- Stainless steel sheet construction provides hygiene, long service life and easy of cleaning.
- Ergonomic design providing convenience to users in all aspects.
- Plate thickness is produced as 12 mm. made of ST52 stainless steel.
- LPG and NG options available.
- Specially designed tubular burner to ensure homogeneous cooking across plate surfaces.

	KOD / CODE	 (MM)	 kg	 (KW)	€
	AIM AGI47-N	400x730x300	47	6,3	-
	AIM AGI67-N	600x730x300	53	9	-
	AIM AGI87-N	800x730x300	78	12,6	-
	AIM AGI127-N	1200x730x300	125	18,9	-

AIM

730 SERİ 730 SERIES

GAZLI IZGARALAR - 1/2 NERVÜRLÜ 1/2 DÜZ PLEYT GAS GRILLS - 1/2 RIBBED 1/2 SMOOTH SURFACE

AGI127-ND







EKNİK DETAYLAR / TECHNICAL DETAILS

TR

- Paslanmaz çelikten imal edilmiştir.
- Paslanmaz sac konstrüksiyonu ile uzun ömürlü kolay temizlenebilir ve hijyeniktir.
- Kullanıcıya her yönden rahatlık sağlayan ergonomik dizayna sahiptir.
- Plate kalınlığı, 12 mm. ST52 çelik malzemeden üretilmiştir.
- LPG ve NG seçenekleri mevcuttur.
- Her biri bağımsız brülörler sayesinde homojen ısı dağılımı sağlanmaktadır.

EN

- Made of stainless steel.
- Stainless steel sheet construction provides hygiene, long service life and easy of cleaning.
- Ergonomic design providing convenience to users in all aspects.
- Plate thickness is produced as 12 mm. made of ST52 stainless steel.
- LPG and NG options available.
- Specially designed tubular burner to ensure homogeneous cooking across plate surfaces.

	KOD / CODE	 (MM)	 kg	 (KW)	€
	AIM AGI67-ND	600x730x300	53	9	-
	AIM AGI87-ND	800x730x300	78	12,6	-
	AIM AGI127-ND	1200x730x300	125	18,9	-

GAZLI IZGARALAR - DÜZ PLEYT - KROM GAS GRILLS - SMOOTH SURFACE - CHROME

CHROME

AGI127-DK







TEKNİK DETAYLAR / TECHNICAL DETAILS

TR

- Paslanmaz çelikten imal edilmiştir.
- Paslanmaz sac konstrüksiyonu ile uzun ömürlü kolay temizlenebilir ve hijyeniktir.
- Kullanıcıya her yönden rahatlık sağlayan ergonomik dizayna sahiptir.
- Plate kalınlığı 12 mm. ST52 çelik malzemeden üretilmiştir.
- LPG ve NG seçenekleri mevcuttur.
- Her biri bağımsız brülörler sayesinde homojen ısı dağılımı sağlanmaktadır.

EN

- Made of stainless steel.
- Stainless steel sheet construction provides hygiene, long service life and easy of cleaning.
- Ergonomic design providing convenience to users in all aspects.
- Plate thickness is produced as 12 mm. made of ST52 stainless steel.
- LPG and NG options available.
- Specially designed tubular burner to ensure homogeneous cooking across plate surfaces.

	KOD / CODE	(MM)	kg	(KW)	€
	AIM AGI47-DK	400x730x300	47	6,3	-
	AIM AGI67-DK	600x730x300	53	9	-
	AIM AGI87-DK	800x730x300	78	12,6	-
	AIM AGI127-DK	1200x730x300	125	18,9	-

AIM

730 SERİ 730 SERIES

GAZLI IZGARALAR - NERVÜRLÜ PLEYT - KROM
GAS GRILLS - RIBBED SURFACE - CHROME

CHROME

AGI127-NK



NERVÜRLÜ PLEYT
RIBBED SURFACE







TEKNİK DETAYLAR / TECHNICAL DETAILS

TR

- Paslanmaz çelikten imal edilmiştir.
- Paslanmaz sac konstrüksiyonu ile uzun ömürlü kolay temizlenebilir ve hijyeniktir.
- Kullanıcıya her yönden rahatlık sağlayan ergonomik dizayna sahiptir.
- Plate kalınlığı 12 mm. ST52 çelik malzemeden üretilmiştir.
- LPG ve NG seçenekleri mevcuttur.
- Her biri bağımsız brülörler sayesinde homojen ısı dağılımı sağlanmaktadır.

EN

- Made of stainless steel.
- Stainless steel sheet construction provides hygiene, long service life and easy of cleaning.
- Ergonomic design providing convenience to users in all aspects.
- Plate thickness is produced as 12 mm. made of ST52 stainless steel.
- LPG and NG options available.
- Specially designed tubular burner to ensure homogeneous cooking across plate surfaces.

	KOD / CODE	 (MM)	 kg	 (KW)	€
	AIM AGI47-NK	400x730x300	47	6,3	-
	AIM AGI67-NK	600x730x300	53	9	-
	AIM AGI87-NK	800x730x300	78	12,6	-
	AIM AGI127-NK	1200x730x300	125	18,9	-

GAZLI IZGARALAR - 1/2 NERVÜRLÜ 1/2 DÜZ PLEYT - KROM GAS GRILLS - 1/2 RIBBED 1/2 SMOOTH SURFACE - CHROME

CHROME

AGI127-NDK



1/2 NERVÜRLÜ 1/2 DÜZ PLEYT
1/2 RIBBED 1/2 SURFACE SURFACE







TEKNİK DETAYLAR / TECHNICAL DETAILS

TR

- Paslanmaz çelikten imal edilmiştir.
- Paslanmaz sac konstrüksiyonu ile uzun ömürlü kolay temizlenebilir ve hijyeniktir.
- Kullanıcıya her yönden rahatlık sağlayan ergonomik dizayna sahiptir.
- Plate kalınlığı 12 mm. ST52 çelik malzemeden üretilmiştir.
- LPG ve NG seçenekleri mevcuttur.
- Her biri bağımsız brülörler sayesinde homojen ısı dağılımı sağlanmaktadır.

EN

- Made of stainless steel.
- Stainless steel sheet construction provides hygiene, long service life and easy of cleaning.
- Ergonomic design providing convenience to users in all aspects.
- Plate thickness is produced as 12 mm. made of ST52 stainless steel.
- LPG and NG options available.
- Specially designed tubular burner to ensure homogeneous cooking across plate surfaces.

	KOD / CODE	 (MM)	 kg	 (KW)	€
	AIM AGI167-NDK	600x730x300	53	9	-
	AIM AGI187-NDK	800x730x300	78	12,6	-
	AIM AGI127-NDK	1200x730x300	125	18,9	-

AIM

730 SERİ 730 SERIES

ELEKTRİKLİ IZGARALAR - DÜZ PLEYT ELECTRICAL GRILLS - SMOOTH SURFACE

AEI127-D



DÜZ PLEYT
SMOOTH SURFACE









TEKNİK DETAYLAR / TECHNICAL DETAILS

TR

- Paslanmaz çelikten imal edilmiştir.
- Paslanmaz sac konstrüksiyonu ile uzun ömürlü kolay temizlenebilir ve hijyeniktir.
- Kullanıcıya her yönden rahatlık sağlayan ergonomik dizayna sahiptir.
- Plate kalınlığı 12 mm. ST52 çelik malzemeden üretilmiştir.
- Cihazda bulunan rezistanslar sayesinde pişirme yüzeyinde homojen bir ısı dağılımı sağlanır.

EN

- Made of stainless steel.
- Stainless steel sheet construction provides hygiene, long service life and easy of cleaning.
- Ergonomic design providing convenience to users in all aspects.
- Plate thickness is produced as 12 mm. made of ST52 stainless steel.
- Specially designed heating elements to ensure homogeneous cooking across plate surfaces.

	KOD / CODE	 (MM)	 kg		 (KW)	€
	AIM AEI47-D	400x730x300	47	380-410 V	5,1	-
	AIM AEI67-D	600x730x300	53	380-410 V	6,8	-
	AIM AEI87-D	800x730x300	78	380-410 V	10,2	-
	AIM AEI127-D	1200x730x300	125	380-410 V	15,3	-

ELEKTRİKLİ IZGARALAR - NERVÜRLÜ PLEYT ELECTRICAL GRILLS - RIBBED SURFACE











TEKNİK DETAYLAR / TECHNICAL DETAILS

TR

- Paslanmaz çelikten imal edilmiştir.
- Paslanmaz sac konstrüksiyonu ile uzun ömürlü kolay temizlenebilir ve hijyeniktir.
- Kullanıcıya her yönden rahatlık sağlayan ergonomik dizayna sahiptir.
- Plate kalınlığı 12 mm. ST52 çelik malzemeden üretilmiştir.
- Cihazda bulunan rezistanslar sayesinde pişirme yüzeyinde homojen bir ısı dağılımı sağlanır.

EN

- Made of stainless steel.
- Stainless steel sheet construction provides hygiene, long service life and easy of cleaning.
- Ergonomic design providing convenience to users in all aspects.
- Plate thickness is produced as 12 mm. made of ST52 stainless steel.
- Specially designed heating elements to ensure homogeneous cooking across plate surfaces.

	KOD / CODE	 [MM]	 kg	 V	 [KW]	 €
	AIM AEI47-N	400x730x300	47	380-410 V	5,1	-
	AIM AEI67-N	600x730x300	53	380-410 V	6,8	-
	AIM AEI87-N	800x730x300	78	380-410 V	10,2	-
	AIM AEI127-N	1200x730x300	125	380-410 V	15,3	-

AIM

730 SERİ 730 SERIES

ELEKTRİKLİ IZGARALAR - 1/2 NERVÜRLÜ 1/2 DÜZ PLEYT ELECTRICAL GRILLS - 1/2 RIBBED 1/2 SMOOTH SURFACE









TEKNİK DETAYLAR / TECHNICAL DETAILS

TR

- Paslanmaz çelikten imal edilmiştir.
- Paslanmaz sac konstrüksiyonu ile uzun ömürlü kolay temizlenebilir ve hijyeniktir.
- Kullanıcıya her yönden rahatlık sağlayan ergonomik dizayna sahiptir.
- Plate kalınlığı 12 mm. ST52 çelik malzemeden üretilmiştir.
- Cihazda bulunan rezistanslar sayesinde pişirme yüzeyinde homojen bir ısı dağılımı sağlanır.

EN

- Made of stainless steel.
- Stainless steel sheet construction provides hygiene, long service life and easy of cleaning.
- Ergonomic design providing convenience to users in all aspects.
- Plate thickness is produced as 12 mm. made of ST52 stainless steel.
- Specially designed heating elements to ensure homogeneous cooking across plate surfaces.

	KOD / CODE	 (MM)	 kg		 (KW)	€
	AIM AEI67-ND	600x730x300	53	380-410 V	6,8	-
	AIM AEI87-ND	800x730x300	78	380-410 V	10,2	-
	AIM AEI127-ND	1200x730x300	125	380-410 V	15,3	-

ELEKTRİKLİ IZGARALAR - DÜZ PLEYT - KROM ELECTRICAL GRILLS - SMOOTH SURFACE - CHROME

CHROME











TEKNİK DETAYLAR / TECHNICAL DETAILS

TR

- Paslanmaz çelikten imal edilmiştir.
- Paslanmaz sac konstrüksiyonu ile uzun ömürlü kolay temizlenebilir ve hijyeniktir.
- Kullanıcıya her yönden rahatlık sağlayan ergonomik dizayna sahiptir.
- Plate kalınlığı 12 mm. ST52 çelik malzemeden üretilmiştir.
- Cihazda bulunan rezistanslar sayesinde pişirme yüzeyinde homojen bir ısı dağılımı sağlanır.

EN

- Made of stainless steel.
- Stainless steel sheet construction provides hygiene, long service life and easy of cleaning.
- Ergonomic design providing convenience to users in all aspects.
- Plate thickness is produced as 12 mm. made of ST52 stainless steel.
- Specially designed heating elements to ensure homogeneous cooking across plate surfaces.

	KOD / CODE	 [MM]	 kg		 [KW]	
	AIM AEI47-DK	400x730x300	47	380-410 V	5,1	-
	AIM AEI67-DK	600x730x300	53	380-410 V	6,8	-
	AIM AEI87-DK	800x730x300	78	380-410 V	10,2	-
	AIM AEI127-DK	1200x730x300	125	380-410 V	15,3	-

AIM

730 SERİ 730 SERIES

ELEKTRİKLİ IZGARALAR - NERVÜRLÜ PLEYT - KROM ELECTRICAL GRILLS - RIBBED SURFACE - CHROME

CHROME

AEI127-NK











TEKNİK DETAYLAR / TECHNICAL DETAILS

TR

- Paslanmaz çelikten imal edilmiştir.
- Paslanmaz sac konstrüksiyonu ile uzun ömürlü kolay temizlenebilir ve hijyeniktir.
- Kullanıcıya her yönden rahatlık sağlayan ergonomik dizayna sahiptir.
- Plate kalınlığı 12 mm. ST52 çelik malzemeden üretilmiştir.
- Cihazda bulunan rezistanslar sayesinde pişirme yüzeyinde homojen bir ısı dağılımı sağlanır.

EN

- Made of stainless steel.
- Stainless steel sheet construction provides hygiene, long service life and easy of cleaning.
- Ergonomic design providing convenience to users in all aspects.
- Plate thickness is produced as 12 mm. made of ST52 stainless steel.
- Specially designed heating elements to ensure homogeneous cooking across plate surfaces.

	KOD / CODE	 (MM)	 kg	 V	 (KW)	€
	AIM AEI47-NK	400x730x300	47	380-410 V	5,1	-
	AIM AEI67-NK	600x730x300	53	380-410 V	6,8	-
	AIM AEI87-NK	800x730x300	78	380-410 V	10,2	-
	AIM AEI127-NK	1200x730x300	125	380-410 V	15,3	-

ELEKTRİKLİ IZGARALAR - 1/2 NERVÜRLÜ 1/2 DÜZ PLEYT - KROM ELECTRICAL GRILLS - 1/2 RIBBED 1/2 SMOOTH SURFACE - CHROME

CHROME

AEI127-NDK









TEKNİK DETAYLAR / TECHNICAL DETAILS

TR

- Paslanmaz çelikten imal edilmiştir.
- Paslanmaz sac konstrüksiyonu ile uzun ömürlü kolay temizlenebilir ve hijyeniktir.
- Kullanıcıya her yönden rahatlık sağlayan ergonomik dizayna sahiptir.
- Plate kalınlığı 12 mm. ST52 çelik malzemeden üretilmiştir.
- LPG ve NG seçenekleri mevcuttur.
- Her biri bağımsız brülörler sayesinde homojen ısı dağılımı sağlanmaktadır.

EN

- Made of stainless steel.
- Stainless steel sheet construction provides hygiene, long service life and easy of cleaning.
- Ergonomic design providing convenience to users in all aspects.
- Plate thickness is produced as 12 mm. made of ST52 stainless steel.
- LPG and NG options available.
- Specially designed tubular burner to ensure homogeneous cooking across plate surfaces.

	KOD / CODE	 [MM]	 kg	 V	 [KW]	€
	AIM AEI67-NDK	600x730x300	53	380-410 V	6,8	-
	AIM AEI87-NDK	800x730x300	78	380-410 V	10,2	-
	AIM AEI127-NDK	1200x730x300	125	380-410 V	15,3	-

AIM

730 SERİ 730 SERIES

GAZLI LAVATAŞLI IZGARALAR GAS LAVASTONE GRILLS

ALG127









TEKNİK DETAYLAR / TECHNICAL DETAILS

TR

- Paslanmaz çelikten imal edilmiştir.
- Paslanmaz sac konstrüksiyonu ile uzun ömürlü kolay temizlenebilir ve hijyeniktir.
- Kullanıcıya her yönden rahatlık sağlayan ergonomik dizayna sahiptir.
- Cihazda pişirme yapılan ızgara kısmı dökümden imal edilmiştir.
- LPG ve NG seçenekleri mevcuttur.

EN

- Made of stainless steel.
- Stainless steel sheet construction provides hygiene, long service life and easy of cleaning.
- Ergonomic design providing convenience to users in all aspects.
- Cooking surface made of cast iron.
- LPG and NG options available.

	KOD / CODE	 (MM)	 kg	 (KW)	€
	AIM ALG47	400x730x300	57	5	-
	AIM ALG67	600x730x300	75	5,5	-
	AIM ALG87	800x730x300	96	10	-
	AIM ALG127	1200x730x300	143	15	-

GAZLI AMERİKAN IZGARALAR GAS AMERICAN GRILLS

AAG127









TEKNİK DETAYLAR / TECHNICAL DETAILS

TR

- Paslanmaz çelikten imal edilmiştir.
- Paslanmaz sac konstrüksiyonu ile uzun ömürlü kolay temizlenebilir ve hijyeniktir.
- Kullanıcıya her yönden rahatlık sağlayan ergonomik dizayna sahiptir.
- Cihazda pişirme yapılan ızgara kısmı dökümden imal edilmiştir.
- LPG ve NG seçenekleri mevcuttur.

EN

- Made of stainless steel.
- Stainless steel sheet construction provides hygiene, long service life and easy of cleaning.
- Ergonomic design providing convenience to users in all aspects.
- Cooking surface made of cast iron.
- LPG and NG options available.

	KOD / CODE	 (MM)	 kg	 (KW)	€
	AIM AAG47	400x730x300	57	9	-
	AIM AAG67	600x730x300	75	12	-
	AIM AAG87	800x730x300	96	18	-
	AIM AAG127	1200x730x300	143	24	-

AIM

730 SERİ 730 SERIES

ELEKTRİKLİ AMERİKAN IZGARALAR ELECTRICAL AMERICAN GRILLS

ALE67









TEKNİK DETAYLAR / TECHNICAL DETAILS

TR

- Paslanmaz çelikten imal edilmiştir.
- Paslanmaz sac konstrüksiyonu ile uzun ömürlü kolay temizlenebilir ve hijyeniktir.
- Kullanıcıya her yönden rahatlık sağlayan ergonomik dizayna sahiptir.
- Tabanda bulunan hazne içerisindeki su, yağdan kaynaklı duman ve koku oluşumunu minimize eder.
- Cihaz üzerinde bulunan 7 kademeli termostat ile ısıyı istenilen şekilde ayarlayabilme imkanı sağlar.
- Tahliye musluğu bulunmaktadır.
- Cihazdaki rezistanslar yukarı yönlü hareketli olup kolay temizlik imkanı sağlar.

EN

- Made of stainless steel.
- Stainless steel sheet construction provides hygiene, long service life and easy of cleaning.
- Ergonomic design providing convenience to users in all aspects.
- With the 7 steps thermostat on the device, it provides the opportunity to adjust the temperature as requested.
- Equipped drain tap.
- When the resistors are in the upward position, the electricity is cut off with safety switch.

	KOD / CODE	 (MM)	 kg		 (KW)	€
	AIM ALE47	400x730x300	57	380-410 V	3,5	-
	AIM ALE67	600x730x300	77	380-410 V	5,5	-

ELEKTRİKLİ FRİTÖZLER ELECTRICAL FRYERS

AEF87





TEKNİK DETAYLAR / TECHNICAL DETAILS

TR

- Paslanmaz çelikten imal edilmiştir.
- Paslanmaz sac konstrüksiyonu ile uzun ömürlü kolay temizlenebilir ve hijyeniktir.
- Kullanıcıya her yönden rahatlık sağlayan ergonomik dizayna sahiptir.
- Yağ sıcaklığı 100°C -190°C arasında termostat ile kontrol edilir.
- Cihazda emniyet amaçlı limit termostatu bulunur.
- Cihazdaki rezistanslar yukarı yönlü hareketli olup kolay temizlik imkanı sağlar.

EN

- Made of stainless steel.
- Stainless steel sheet construction provides hygiene, long service life and easy of cleaning.
- Ergonomic design providing convenience to users in all aspects.
- Oil temperature is controlled by thermostat between 100°-190°C.
- Equipped with limiting thermostat.
- When the resistors are in the upward position, the electricity is cut of with safety switch.

	KOD / CODE	(MM)	kg	KAPASİTE / CAPACITY		(KW)	€
	AIM AEF47	400x730x300	23	Min. 6 lt Max. 12 lt.	380-410 V	9	-
	AIM AEF87	800x730x300	43	Min. 12 lt Max. 24 lt.	380-410 V	18	-

AIM

730 SERİ 730 SERIES

GAZLI FRİTÖZLER GAS FRYERS

AGF87





TEKNİK DETAYLAR / TECHNICAL DETAILS

TR

- Paslanmaz çelikten imal edilmiştir.
- Paslanmaz sac konstrüksiyonu ile uzun ömürlü kolay temizlenebilir ve hijyeniktir.
- Kullanıcıya her yönden rahatlık sağlayan ergonomik dizayna sahiptir.
- Cihazda yüksek kalori sağlayan brülörler kullanılmaktadır.
- LPG ve NG seçenekleri mevcuttur.

EN

- Made of stainless steel.
- Stainless steel sheet construction provides hygiene, long service life and easy of cleaning.
- Ergonomic design providing convenience to users in all aspects.
- Specially designed tubular burner to ensure homogeneous cooking across plate surfaces.
- LPG and NG options available

	KOD / CODE	 (MM)	 kg	KAPASİTE / CAPACITY	 (KW)	€
	AIM AGF47	400x700x850	25	Min. 18 lt Max. 22 lt.	8,5	-
	AIM AGF87	800x700x850	41	Min. 2x18 lt Max. 2x22 lt.	17	-

PATATES DİNLENDİRME CHIPS SCUTTLE

AWK47







TEKNİK DETAYLAR / TECHNICAL DETAILS

TR

- Paslanmaz çelikten imal edilmiştir.
- Paslanmaz sac konstrüksiyonu ile uzun ömürlü kolay temizlenebilir ve hijyeniktir.
- Cihaz içerisinde yağın süzülmesi için delikli sac bulunmaktadır.
- Cihazda seramik rezistans kullanılmıştır.

EN

- Made of stainless steel.
- Stainless steel sheet construction provides hygiene, long service life and easy of cleaning.
- Equipped with porcelain heater.
- Used for holding chips at perfect serving temperature and condition.

	KOD / CODE	 (MM)	 kg	KAPASİTE / CAPACITY	 V	 (KW)	€
	AIM AWK47	400x730x300	19	GN 1/1 150	220-240 V	0,65	-

AIM

730 SERİ 730 SERIES

ELEKTRİKLİ BENMARI ELECTRICAL BAINMARIE

BN87







TEKNİK DETAYLAR / TECHNICAL DETAILS

TR

- Paslanmaz çelikten imal edilmiştir.
- Paslanmaz sac konstrüksiyonu ile uzun ömürlü kolay temizlenebilir ve hijyeniktir.
- Cihaz 30°-90°C aralığında termostat ile kontrol edilir.
- Cihazda kilitli boşaltma vanası sayesinde kullanıcı kontrolü dışında açılıp boşaltma yapılamaz.

EN

- Made of stainless steel.
- Stainless steel sheet construction provides hygiene, long service life and easy of cleaning.
- Ergonomic design providing convenience to users in all aspects.
- The device is controlled by a thermostat in the range of 30°-90°C .

	KOD / CODE	 (MM)	 kg	KAPASİTE / CAPACITY		 (KW)	€
	AIM BN47	400x730x300	21	GN 1/1 150	220-240 V	1,5	-
	AIM BN87	800x730x300	36	GN 1/1 150 x 2	220-240 V	3	-

ELEKTRİKLİ MAKARNA HAŞLAMALAR ELECTRICAL PASTA COOKERS

PC66









TEKNİK DETAYLAR / TECHNICAL DETAILS

TR

- Paslanmaz çelikten imal edilmiştir.
- Paslanmaz sac konstrüksiyonu ile uzun ömürlü kolay temizlenebilir ve hijyeniktir.
- Cihazda kilitli boşaltma vanası sayesinde kullanıcı kontrolü dışında açılıp boşaltma yapılamaz.
- Cihazda temiz su girişi musluğu ve taşan su tahliyesi mevcuttur.
- Cihazda enerji regülatörü ile ısı kontrolü sağlanır.
- Aşırı ısınmaya karşı limit termostat bulunur.

EN

- Made of stainless steel.
- Stainless steel sheet construction provides hygiene long service life and easy of cleaning.
- The device has a locked drain valve. It cannot be turned on/off without user control.
- The device has a clean water inlet tap and an overflowing water drain.
- Heat control is provided by the energy regulator in the device.
- It has a heat regulator against over heating.

	KOD / CODE	 (MM)	 kg	 V	 (KW)	€
	AIM PC47	400x730x300	21	380-410 V	5	-
	AIM PC67	600x730x300	28	380-410 V	7,5	-
	AIM PC87	800x730x300	36	380-410 V	10	-

AIM

730 SERİ 730 SERIES

ELEKTRİKLİ SETALTI FIRINLAR ELECTRICAL UNDERCOUNTER OVENS

SMEF127**MAXI**









TEKNİK DETAYLAR / TECHNICAL DETAILS

TR

- Paslanmaz çelikten imal edilmiştir.
- Paslanmaz sac konstrüksiyonu ile uzun ömürlü kolay temizlenebilir ve hijyeniktir.
- Cihazda bulunan rezistanslar 50°-300°C aralığında çalışır. isteğe göre ayrı ayrı kontrol edilebilir.
- ST modellerinde; cihazın tabanında ısıyı homojen olarak dağıtmak için 10 mm. kalınlığında ST Serisi çelik plate bulunmaktadır.
- F modellerinde; fırında iç hacmi homojen olarak ısıtan AC fan bulunmaktadır.
- Ürün üzerinde aynı seriden farklı ürünler konumlandırılabilir.
- Fırın içerisinde 2 adet 530 x 400 mm. tel ızgara bulunmaktadır.

EN

- Made of stainless Steel
- Stainless steel sheet construction provides hygiene, long service life and easy of cleaning.
- The resistances in the device operate in the range of 50°-300°C degrees. It can be individually controlled optionally.
- In the ST model, in order to homogenize the heat at the base of the device, 10mm thick ST model steel is produced.
- There is an AC fan that heats the internal volume homogeneously in F models.
- Different products from the same series can be put on the product.
- There are 2 pieces 530x400 mm wire grids in the oven.

	KOD / CODE	 (MM)	 kg	KAPASİTE / CAPACITY		 (kW)	€
	AIM SSEF87	800x730x550	45	GN 2/1	380-415 V	6,3	-
	AIM SFEF87	800x730x550	45	GN 2/1	380-413 V	2,6	-
	AIM SMEF127	1200x730x550	85	650x930	380-415 V	12	-
	AIM SDEF127	1200x730x550	80	GN 2/1	380-413 V	6,3	-

GAZLI SETALTI FIRINLAR GAS UNDERCOUNTER OVENS

SMGF127









TEKNİK DETAYLAR / TECHNICAL DETAILS

TR

- Paslanmaz çelikten imal edilmiştir.
- Paslanmaz sac konstrüksiyonu ile uzun ömürlü kolay temizlenebilir ve hijyeniktir.
- Fırında sıcaklık 60° -300° C aralığında bir adet termostatlı gaz musluğu ile kontrol edilir.
- Cihazda pilotlu ve termokupullu kontrol sistemi bulunmaktadır. Termokupul sayesinde alev söndüğünde cihaza gelen gaz otomatik olarak kesilir.
- LPG ve NG seçenekleri mevcuttur.

EN

- Made of stainless Steel
- Stainless steel sheet construction provides hygiene, long service life and easy of cleaning.
- The temperature in the oven is controlled by a thermostatic gas tap in the range of 60°-300°C degrees.
- The device has a piloted and thermocouple control system. When the flame goes out with the thermocouple, the gas coming to the device is automatically cut off.
- LPG and NG options available.

	KOD / CODE	 (MM)	 kg	KAPASİTE / CAPACITY	 (KW)	€
	AIM SGF87	800x730x550	45	GN 2/1	6,3	-
	AIM SMGF127	1200x730x550	85	650x930	9,5	-
	AIM SDGF127	1200x730x550	80	GN 2/1	6,3	-

AIM

730 SERİ 730 SERIES

NÖTR TEZGAHLAR NEUTRAL WORKTOP

NW127







TEKNİK DETAYLAR / TECHNICAL DETAILS

TR

- Paslanmaz çelikten imal edilmiştir.
- Paslanmaz sac konstrüksiyonu ile uzun ömürlü kolay temizlenebilir ve hijyeniktir.
- Kullanıcıya her açıdan kolaylık sağlayan ergonomik tasarım.

EN

- Made of stainless steel.
- Stainless steel sheet construction provides hygiene, long service life and easy of cleaning.
- Ergonomic design providing convenience to users in all aspects.

	KOD / CODE	 (MM)	 kg	€
	AIM NW47	400x730x300	16	-
	AIM NW67	600x730x300	22	-
	AIM NW87	800x730x300	27	-
	AIM NW127	1200x730x300	43	-

SETALTI DOLAPLAR UNDERCOUNTER CABINETS

UC127









TEKNİK DETAYLAR / TECHNICAL DETAILS

TR

- Paslanmaz çelikten imal edilmiştir.
- Paslanmaz sac konstrüksiyonu ile uzun ömürlü kolay temizlenebilir ve hijyeniktir.
- Kapılar çift cidarlıdır.
- Setaltı tezgahların üzerinde bulunan pimler cihazların altındaki yuvalara göre tasarlanmış olup ürünlerin tek parça olarak görünmesini sağlar.

EN

- Made of stainless steel.
- Stainless steel sheet construction provides hygiene, long service life and easy of cleaning.
- Double-wall walled.
- Pins on the undercounter cabinets are designed for the top equipment so that the products have a uniform look.

	KOD / CODE	 (MM)	 kg	€
	AIM UC47	400x730x550	14	-
	AIM UC67	600x730x550	18	-
	AIM UC87	800x730x550	23	-
	AIM UC127	1200x730x550	27	-

ÖZEL SERİ PIŞİRİCİLER



SPECIAL
COOKING
LINE



AIM

ÖZEL SERİ PİŞİRİCİLER SPECIAL COOKING LINE

YER OCAKLARI FLOOR TYPE COOKERS

YRG60-1



YRG60-2





TEKNİK DETAYLAR / TECHNICAL DETAILS

TR

- Paslanmaz çelik gövde.
- Nikel kaplı döküm üst tabla.
- Güvenlik termostati.
- Paslanmaz çelik ayarlanabilir ayaklar.
- Doğalgaz veya LPG ile çalışma imkanı.

EN

- Made of stainless steel
- Nickel plated cast iron grate
- Regulation by means of a gas tap
- With safety thermocouple.
- Stainless steel legs adjustable in height
- Operation with NG or LPG

KOD / CODE	 (MM)	 (KW)	€
AIM YRG50	500x500x450	13	-
AIM YRG60-1	600x600x450	19	-
AIM YRG60-2	600x600x450	28	-

GAZLI OCAKLAR GAS COOKERS

OCK-2



OCK-4



OCK-6





TEKNİK DETAYLAR / TECHNICAL DETAILS

TR

- Paslanmaz çelik gövde.
- Nikel kaplı döküm üst tabla.
- Hijyenik kullanım için pislik tavası.
- Kapaksız alt depolama alanı.
- Yüksek performanslı brülör.
- Paslanmaz çelik ayarlanabilir ayaklar.
- Doğalgaz veya LPG ile çalışma imkanı.

EN

- Made of stainless steel
- Burners of nickel cast iron
- Very high efficiency
- With catching plate for cooking liquid
- Regulation through gas valve With open cabine
- Operation with NG or LPG

KOD / CODE	 (MM)	 (KW)	€
AIM OCK-2	400x700x850	2x6,5	-
AIM OCK-4	700x700x850	4x6,5	-
AIM OCK-6	1100x700x850	6x6,5	-

AIM

ÖZEL SERİ PİŞİRİCİLER SPECIAL COOKING LINE

SETÜSTÜ OCAKLARI TABLETOP GAS COOKERS

STO-3





TEKNİK DETAYLAR / TECHNICAL DETAILS

TR

- Paslanmaz çelik gövde.
- Bakır brülör.
- Paslanmaz çelik yağ toplama haznesi.
- Doğalgaz veya LPG ile çalışma imkanı.

EN

- Made of stainless steel
- Copper burner.
- Stainless steel collection trays
- Operation with NG or LPG

KOD / CODE	 (MM)	 (KW)	€
AIM STO-1	370x510x200	7	-
AIM STO-2	690x510x200	14	-
AIM STO-3	1010x510x200	21	-

ELEKTRİKLİ SETÜSTÜ FRİTÖZLER ELECTRICAL TABLETOP FRYERS

FRT-F2







TEKNİK DETAYLAR / TECHNICAL DETAILS

TR

- Paslanmaz çelik gövde.
- Güvenlik termostatu.
- 12+12 Lt hazne kapasitesi
- Ön tahliye vanası

EN

- Made of stainless steel
- Safety Thermostat.
- 12+12 Lt capacity.
- Oil drain valve

KOD / CODE	 (MM)	 kg	KAPASİTE / CAPACITY		 (KW)	€
AIM FRT-M1	325x650x410	25	12 lt.	380-410 V	9	-
AIM FRT-M2	650x650x410	35	12+12 lt.	380-410 V	18	-

AIM

ÖZEL SERİ PİŞİRİCİLER SPECIAL COOKING LINE

ELEKTRİKLİ AMERİKAN TİP FRİTÖZ ELECTRICAL AMERICAN TYPE FRYER

FRT-E

TEKNİK DETAYLAR / TECHNICAL DETAILS

TR

- Derin soğuk bölge
- Kızartma yağının ömrünü uzatan derin bir soğuk bölge vardır.
- Kızartma kabı tamamen paslanmaz çelikten yapılmıştır ve termal korumalıdır.
- Bölünmüş tank, 2 ayrı ayarlanabilir termostat.
- Eşit ısı dağılımı

EN

- Deep cold zone
- There is a deep cold zone which extends the life of the frying oil
- The frypot is made entirely of stainless steel, with thermal protection.
- Split tank.
- Homogeneous heat distribution

KOD / CODE	 (MM)	 kg	KAPASİTE / CAPACITY		 (kW)	€
AIM FRT-E1	420x832x850	91	2x13 lt.	380-410 V	2x9	-

GAZLI AMERİKAN TİP FRİTÖZ GAS AMERICAN TYPE FRYER

FRT-G

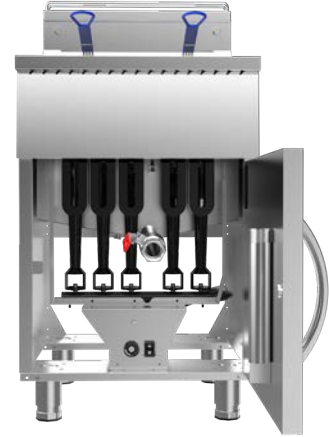



TEKNİK DETAYLAR / TECHNICAL DETAILS

TR

- Paslanmaz çelikten imal edilmiştir.
- Paslanmaz sac konstrüksiyonu ile uzun ömürlü kolay temizlenebilir ve hijyeniktir.
- Kullanıcıya her yönden rahatlık sağlayan ergonomik dizayna sahiptir.
- Cihazda yüksek kalori sağlayan brülörler kullanılmaktadır.
- Cihaz üzerinde bulunan 7 kademeli termostat ile ısıyı istenilen şekilde ayarlayabilme imkanı sağlar.
- Cihazda pilotlu ve termokupullu kontrol sistemi bulunmaktadır. Termokupul sayesinde alev söndüğünde cihaza gelen gaz otomatik olarak kesilir.

EN

- Made of stainless steel.
- Stainless steel sheet construction provides hygiene, long service life and easy of cleaning.
- Ergonomic design providing convenience to users in all aspects.
- LPG and NG options available
- Specially designed tubular burner to ensure homogeneous cooking across plate surfaces.
- With the 7 steps thermostat on the device, it provides the opportunity to adjust the temperature as requested.

KOD / CODE	 (MM)		KAPASİTE / CAPACITY	 (KW)	€
AIM FRT-G1	316x760x1110	61	15 lt.	21	-
AIM FRT-G2	400x760x1110	78	21 lt.	27	-
AIM FRT-G3	560x760x1110	91	45 lt.	49	-

AIM

ÖZEL SERİ PİŞİRİCİLER SPECIAL COOKING LINE

GAZLI VE ELEKTRİKLİ DUTCH TİP FRİTÖZ
GAS & ELECTRICAL DUTCH TYPE FRYERS

FRT-ED3

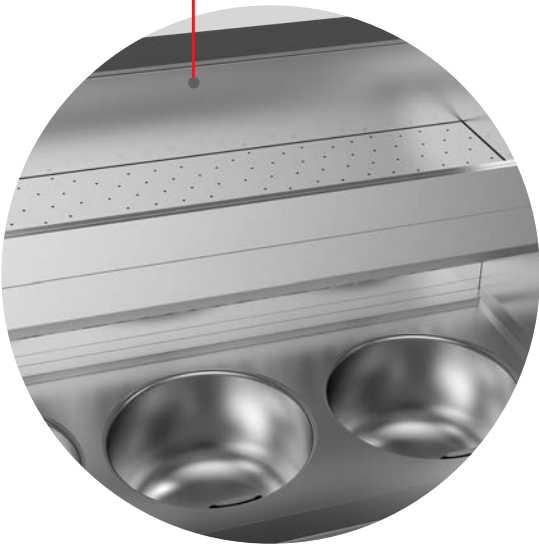

TEKNİK DETAYLAR / TECHNICAL DETAILS



TR

- Üç yuvarlak kazanlı, paslanmaz çelikten (AISI 304/441) yapılmış sağlam gazlı fritöz. Fritöz, küvet başına saatte 50 kilogram (ön kızartma saatte 25 kilogram) kızartma kapasitesine sahiptir.
- 36 cm çapında (paslanmaz çelik kapaklar dahil) üç adet 13 litrelik küvet, alt süzgeci olan soğuk bölgelerle donatılmıştır
- Çift cidarlı üç döner kapı (yalıtımlı)
- Her küvet için düşük tahliye musluğu ve çıkarılabilir ağızlı tahliye (veya filtreleme) (tam güvenlik içinde kolay kullanım)
- Drenaj için alt kısmı delikli, önceden pişirilmiş gıdalar için üst tepsi
- Çok yüksek verimli, yalıtımlı yanma odasına sahip dairesel dökme demir brülör ile ısıtma
- Yanma gazlarını boşaltmak için baca (küvet başına bir adet)
- Termokupl ve piezo ateşlemeli bir güvenlik sistemi ile donatılmış "SIT" tipi termostatik gaz musluğu.
- Her bir küvetin ön tarafındaki sıcaklığın "analog" görüntüsü (7 cm çap)
- CE standartlarını karşılar



EN

- Robust gas deep fryer made of stainless steel (AISI 304/441) with three round tubs. The fryer has a frying capacity of 50 kilograms per hour (pre-frying 25 kilograms per hour) per tub.
- Three 13 liter tubs with a diameter of 36 cm (stainless steel lids included), equipped with cold zones with bottom sieve
- Three revolving doors with double walls (insulated)
- Low drain tap for each tub and drain (or filtration) with removable spout (easy use in complete safety)
- Top tray for pre-cooked foods, with a perforated bottom for drainage
- Heating by circular cast iron burner with very high efficiency, insulated combustion chamber
- Chimney (one per tub) to discharge the combustion gases
- Thermostatic gas tap type "SIT", equipped with a safety system by thermo-couple and piezo ignition.
- Analogue" image of the temperature on the front of each tub (7cm diameter)
- Meets CE standards

GAZ-GAS

KOD / CODE	 (MM)	KAPASİTE / CAPACITY	 (KW)	€
AIM FRT-GD1	550x920x1610	13 lt.	17	-
AIM FRT-GD2	1000x920x1610	13x2 lt.	17x2	-
AIM FRT-GD3	1450x920x1610	13x3 lt.	17x3	-

ELEKTRİK-ELECTRICAL

KOD / CODE	 (MM)	KAPASİTE / CAPACITY		 (KW)	€
AIM FRT-ED1	550x920x1610	13 lt.	380-410 V	11	-
AIM FRT-ED2	1000x920x1610	13x2 lt.	380-410 V	11x2	-
AIM FRT-ED3	1450x920x1610	13x3 lt.	380-410 V	11x3	-

AIM

ÖZEL SERİ PİŞİRİCİLER SPECIAL COOKING LINE

WOK OCAKLARI WOK RANGES

WK-1+1**WK-1**

ÜST TABLA SOĞUTMA SİSTEMİ
TOP COOLING SYSTEM

5 MM ÜST TABLA KALINLIĞI
5 MM TOP THICKNESS



TEKNİK DETAYLAR / TECHNICAL DETAILS

TR

- Paslanmaz çelik AISI 304
- Güçlü dökme demir wok Ø 280 mm
- Daha yüksek performans elde etmek için 1 adet özel tasarım boru brülör
- 400 mm sırtlık
- Üst tabla kalınlığı 5 mm
- Kolay kullanım için kontrol panelinde entegre musluklu soğuk su musluğu
- Wok'un üzerinden su tahliyesine akacak olan soğutma suyu taşıma sistemi

EN

- Stainless steel AISI 304
- Strong cast iron wok ø 280 mm
- Special design of 1 pipe burners to get a higher performance
- Top with splashback of 400 mm
- Table top thickness 5 mm
- Cold water faucet with integrated tap in the control panel for easy use
- Cooling water overflow system which will flows above the wok into the water drain

KOD CODE	 (MM)	WOK BURNER VOK OCAĞI	SOUP BURNER ÇORBA OCAĞI	KW	€
WK-1	610x850x1100	1	0	27,5	-
WK-1+1	1000x850x1100	1	1	36,7	-

WOK OCAKLARI WOK RANGES

WK-1+2



ÜST TABLA SOĞUTMA SİSTEMİ
TOP COOLING SYSTEM

5 MM ÜST TABLA KALINLIĞI
5 MM TOP THICKNESS

WK-2+1



TEKNİK DETAYLAR / TECHNICAL DETAILS

TR

- Paslanmaz çelik AISI 304
- Güçlü dökme demir wok Ø 280 mm
- Daha yüksek performans elde etmek için 1+2/2+1 adet özel tasarım boru brülör
- 400 mm sırtlık
- Üst tabla kalınlığı 5 mm
- Kolay kullanım için kontrol panelinde entegre musluklu soğuk su musluğu
- Wok'un üzerinden su tahliyesine akacak olan soğutma suyu taşma sistemi

EN

- Stainless steel AISI 304
- Strong cast iron wok Ø 280 mm
- Special design of 1+2/2+1 pipe burners to get a higher performance
- Top with splashback of 400 mm
- Table top thickness 5 mm
- Cold water faucet with integrated tap in the control panel for easy use
- Cooling water overflow system which will flows above the wok into the water drain

KOD CODE	 (MM)	WOK BURNER VOK OCAĞI	SOUP BURNER ÇORBA OCAĞI	KW	€
WK-1+2	1390x850x1100	1	2	45,9	-
WK-2+1	1530x850x1100	2	1	64,2	-

AIM

ÖZEL SERİ PİŞİRİCİLER SPECIAL COOKING LINE

WOK OCAKLARI WOK RANGES

WK-2+3**WK-3+2**

ÜST TABLA SOĞUTMA SİSTEMİ
TOP COOLING SYSTEM

5 MM ÜST TABLA KALINLIĞI
5 MM TOP THICKNESS

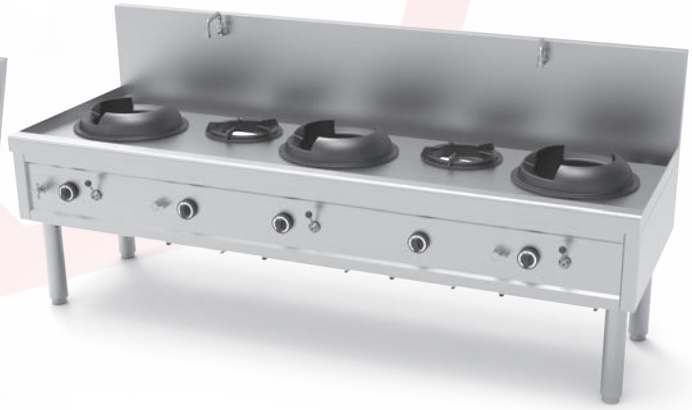

TEKNİK DETAYLAR / TECHNICAL DETAILS

TR

- Paslanmaz çelik AISI 304
- Güçlü dökme demir wok Ø 280 mm
- Daha yüksek performans elde etmek için 2+3/3+2 adet özel tasarım boru brülör
- 400 mm sırtlık
- Üst tabla kalınlığı 5 mm
- Kolay kullanım için kontrol panelinde entegre musluklu soğuk su musluğu
- Wokun üzerinden su tahliyesine akacak olan soğutma suyu taşıma sistemi

EN

- Stainless steel AISI 304
- Strong cast iron wok Ø 280 mm
- Special design of 2+3/3+2 pipe burners to get a higher performance
- Top with splashback of 400 mm
- Table top thickness 5 mm
- Cold water faucet with integrated tap in the control panel for easy use
- Cooling water overflow system which will flows above the wok into the water drain

KOD CODE	 (MM)	WOK BURNER VOK OCAĞI	SOUP BURNER ÇORBA OCAĞI	KW	€
WK-2+3	2310x850x1100	2	3	82,6	-
WK-3+2	2450x850x1100	3	2	100,9	-

WOK OCAKLARI WOK RANGES

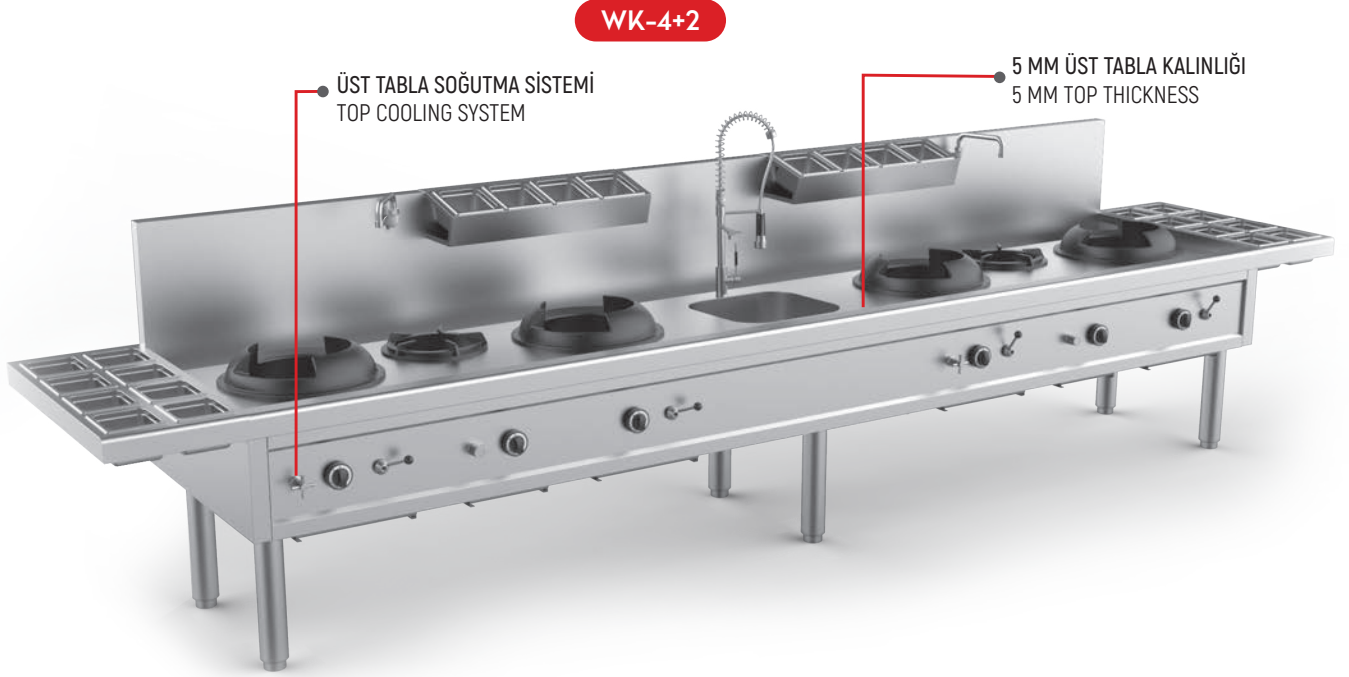

WK-4+2

ÜST TABLA SOĞUTMA SİSTEMİ
TOP COOLING SYSTEM

5 MM ÜST TABLA KALINLIĞI
5 MM TOP THICKNESS

TEKNİK DETAYLAR / TECHNICAL DETAILS

TR

- Paslanmaz çelik AISI 304
- Güçlü dökme demir wok Ø 280 mm
- Daha yüksek performans elde etmek için 2+3/3+2 adet özel tasarım boru brülör
- 400 mm sırtlık
- Üst tabla kalınlığı 5 mm
- Kolay kullanım için kontrol panelinde entegre musluklu soğuk su musluğu
- Wok'un üzerinden su tahliyesine akacak olan soğutma suyu taşıma sistemi

EN

- Stainless steel AISI 304
- Strong cast iron wok Ø 280 mm
- Special design of 2+3/3+2 pipe burners to get a higher performance
- Top with splashback of 400 mm
- Table top thickness 5 mm
- Cold water faucet with integrated tap in the control panel for easy use
- Cooling water overflow system which will flows above the wok into the water drain

KOD CODE	 (MM)	WOK BURNER VOK OCAĞI	SOUP BURNER ÇORBA OCAĞI	KW	€
WK-4+2-E	3750x850x1100	4	2	128,4	-

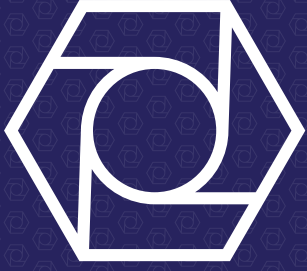

AIM

Merkez Mah. Seçkin Sok. 2-4/A
S Blok K: 1/10 Dap Vadi
Çağlayan - Kağıthane - İstanbul
+90 212 982 38 91
info@aimgastro.com

INDUSTRIAL KITCHEN EQUIPMENT

www.aimgastro.com

[f](#) [@](#) [t](#) [in](#) [v](#) /aimgastro

